



**2023**

**MAMPARAS STD  
Y A MEDIDA**

Servicio inmediato · 100% Stock

# CALIDAD CERTIFICADA



Preocupados por la calidad que ofrecemos a nuestros clientes, GME DIVISIÓN BAÑOS SL dispone de certificados que garantizan la calidad de todos sus productos, los cuales cumplen con todas las normativas europeas.

Al mismo tiempo, GME DIVISIÓN BAÑOS SL está asociado al instituto tecnológico AIDIMME, en el cual, se realizan inspecciones y ensayos de laboratorio para garantizar la calidad y buen funcionamiento de los productos que les ofrecemos.

ASOCIADO N° 11666  
**AIDIMME**  
INSTITUTO TECNOLÓGICO



Los niveles de calidad de nuestros productos nos permiten ampliar a 3 años la garantía establecido por ley. Esta garantía no cubre elementos de plástico ó rodamientos y quedará anulada por el mal uso o manutención de los productos.

# GME

DIVISION BAÑOS



## PRESENCIA INTERNACIONAL

Malta  
Rumanía  
Mauritania  
Marruecos  
Rep. Dominicana  
Estonia

EE.UU.  
Argelia  
Eslovenia  
Bélgica  
Luxemburgo  
Suiza

España  
Portugal  
Andorra  
Francia  
Italia  
Inglaterra



# GME

# IOΦ®

## QUIÉNES SOMOS

GME DIVISIÓN BAÑOS S.L. es un grupo empresarial que pertenece a LORENTE HOLDING VLC. Con más de 25 años de experiencia en la comercialización y distribución de productos orientados al acondicionamiento integral del baño.

El grupo desarrolla dos líneas generales de negocio, una de ellas actúa como delegación de fabricantes de primer nivel, la otra, fabrica y comercializa productos bajo la marca GME.

Mediante el contacto permanente con nuestros clientes a través de nuestra amplia red comercial, desarrollamos las líneas de producto a comercializar que cubran las necesidades actuales del mercado, siempre tratando de mejorar la oferta existente a nivel de precio, calidad y servicio.



Nuestros 25000 m<sup>2</sup> de almacén nos permiten disponer de un amplio stock de todas las referencias de nuestro catálogo. Esto, unido al compromiso de preparar sus pedidos el mismo día de su recepción, hacen posible que los plazos de entrega, en condiciones normales, no supere las 72 horas.

Todo ello hace posible cumplir nuestro objetivo:  
"La calidad sí tiene precio"



TWENTY 11-19

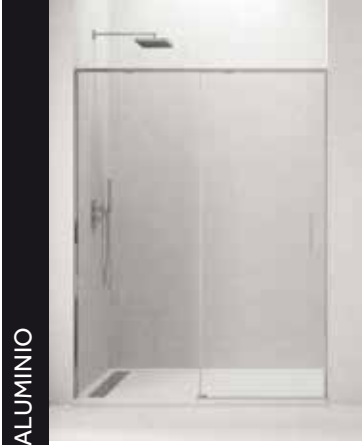

TWENTY SPAZIO 14-15



NOVEDAD

TWENTY VÉRTICE 16-17



NOVEDAD

BASIC 20-35



CORREDERAS ALUMINIO

KENNA 36-43



VITRO 44-55



PRESTIGE 56-65



AKTUAL 66-73



TWENTY GOLD 76-83



NOVEDAD

TWENTY BLACK 84-91



BASIC BLACK 92-103



BASIC WHITE 92-103



BASIC TITANIO 92-103



CORREDERAS COLOR

VETRUM 106-117



TEMPLE 118-125



ROTARY 126-133



FUTURA 134-143



MOVING 144-153



CORREDERAS ACERO

SCREEN 156

SCREEN GOLD 158

SCREEN BLACK 160

SCREEN WHITE 162

BLACK CHESS 164

FIJOS



OPEN 170-203

OPEN BLACK 204-225

GLASS 226-241

ABATIBLES



GLASS PLEGABLE 244-247

G. PLEGABLE BLACK 244-247

TANDEM 248

AKORD 250

PLEGABLES



TRIO 254

BYPASS 256

GIRO 360° 258-261

PUERTA DE PASO 262

+SOLUCIONES



OPEN 1 266



OPEN 1 BLACK 267



OPEN 2 268



GLASS BAÑERA PLEGABLE 269



SCREEN BAÑERA 270



SCREEN BLACK BAÑERA 270



SCREEN GOLD BAÑERA 271



SCREEN WHITE BAÑERA 271



SOLUCIONES BAÑERA

BASIC BAÑERA 272-279



BASIC BLACK BAÑERA 272-279



BASIC WHITE BAÑERA 272-279



BASIC TITANIO BAÑERA 272-279



A MEDIDA 280-285



REPUESTOS 286-293



VINILO POLIMÉRICO 294



IMPRESIÓN DIGITAL 294



A MEDIDA

PLATOS DE DUCHA

ARDESIA PLUS 298



ARD. SEMICIRCULAR 300



STYLE PLUS 302



SIDE PLUS 304



HIDDEN PLUS 306



RESITEC ROCK 308



PANELES 310



ENMARCADOS 311



MONOMANDOS 315



DUCHA 317



EMPOTRABLES LAV. 319



EMPOTRABLES 319



COCINA 321



GRIFERÍA

La mayor gama de mamparas del mercado con entrega inmediata  
**Plazo medio de entrega 48h**



TWENTY pg.10



BASIC pg.20



KENNA pg.36



VITRO pg.44

PRESTIGE pg.56

AKTUAL pg.66



**MAMPARAS  
ALUMINIO  
CORREDERAS**



# twenty

## 20mm

"Tecnología y belleza con sus tan solo 20mm de perfilería y cierre Soft Close"





TWENTY 1 fijo+1 corredera



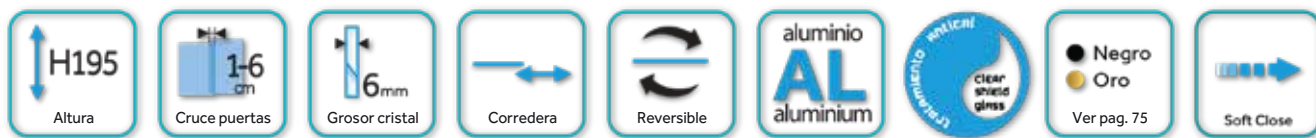

Frontales TWENTY 1fijo + 1corredera

Descripción	Rango	Apertura	Ref.	Puntos
Frontal ducha TWENTY 120	115-120	46-51	2000+2021	388
Frontal ducha TWENTY 125	120-125	49-54	2001+2021	392
Frontal ducha TWENTY 130	125-130	51-56	2002+2021	396
Frontal ducha TWENTY 135	130-135	54-59	2003+2021	400
Frontal ducha TWENTY 140	135-140	56-61	2004+2021	404
Frontal ducha TWENTY 145	140-145	59-64	2005+2021	408
Frontal ducha TWENTY 150	145-150	61-66	2006+2021	412
Frontal ducha TWENTY 155	150-155	64-69	2007+2022	468
Frontal ducha TWENTY 160	155-160	66-71	2008+2022	472
Frontal ducha TWENTY 165	160-165	69-74	2009+2022	476
Frontal ducha TWENTY 170	165-170	71-76	2010+2022	479
Frontal ducha TWENTY 175	170-175	74-79	2011+2022	484
Frontal ducha TWENTY 180	175-180	76-81	2012+2022	488



Guiador desmontable



Rodamiento oculto



Doble asa metálica



Cierre/apertura soft close



Mamparas a medida y cristales especiales	TRANSPARENTE	FROST PLUS PARSOL / MATE	CAJONADO
	+45%	+60%	+21

\*Plazo de entrega 15 días (más información en pág. 280)

## TWENTY SPAZIO 2 fijos+2 correderas



	TRANSPARENTE	FROST PLUS PARSOL / MATE	CAJONADO
Mamparas a medida y cristales especiales	+45%	+60%	+21

\*Plazo de entrega 15 días (más información en pág. 280)

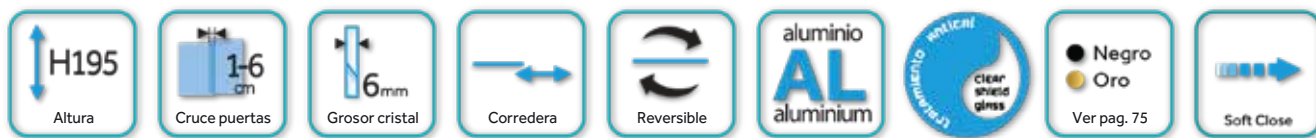

## TWENTY SPAZIO 2 fijos + 2 correderas

Descripción	Rango	Apertura	Referencias	Puntos
TWENTY SPAZIO 2F2C 140	131-141	44-54	2031+2031+2042	580
TWENTY SPAZIO 2F2C 150	141-151	49-59	2032+2032+2042	588
TWENTY SPAZIO 2F2C 160	151-161	54-64	2033+2033+2042	598
TWENTY SPAZIO 2F2C 170	161-171	59-69	2034+2034+2042	608
TWENTY SPAZIO 2F2C 180	171-181	64-74	2035+2035+2042	616
TWENTY SPAZIO 2F2C 190	181-191	69-79	2036+2036+2042	624

\*Admite lateral fijo en ambos lados



Innovador sistema antivuelco



Rodamiento oculto



Doble asa metálica



Apertura soft close



## TWENTY angular al vértice



Mamparas a medida y cristales especiales

TRANSPARENTE

+45%

FROST PLUS  
PARSOL / MATE

+60%

CAJONADO

+21

\*Plazo de entrega 15 días (más información en pág. 280)

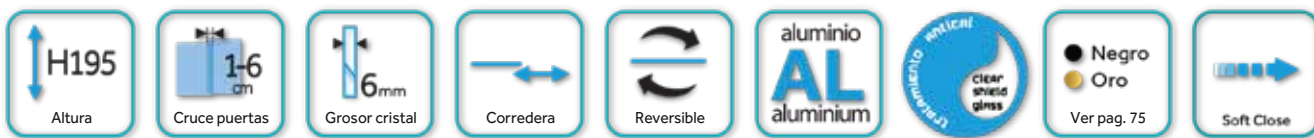

combinaciones frontales TWENTY + lateral fijo de 6 mm

Medida	Rangos	Apertura	Referencias	Puntos
70X70	65-70/65-70	30-35	2030+2030+2038	578
75X70	70-75/65-70	32-37	2031+2030+2038	583
80X70	75-80/65-70	34-39	2032+2030+2038	587
85X70	80-85/65-70	36-41	2033+2030+2038	592
90X70	85-90/65-70	38-43	2034+2030+2038	597
95X70	90-95/65-70	40-45	2035+2030+2038	601
100X70	95-100/65-70	42-47	2036+2030+2038	605
120X70	115-120/65-70	52-57	2037+2030+2038	624
Medida	Rangos	Apertura	Referencias	Puntos
75X75	70-75/70-75	34-39	2031+2031+2038	588
80X75	75-80/70-75	36-41	2032+2031+2038	592
85X75	80-85/70-75	38-43	2033+2031+2038	597
90X75	85-90/70-75	40-45	2034+2031+2038	602
95X75	90-95/70-75	42-47	2035+2031+2038	606
100X75	95-100/70-75	45-50	2036+2031+2038	610
120X75	115-120/70-75	54-59	2037+2031+2038	629
Medida	Rangos	Apertura	Referencias	Puntos
80X80	75-80/75-80	38-43	2032+2032+2038	596
85X80	80-85/75-80	40-45	2033+2032+2038	601
90X80	85-90/75-80	42-47	2034+2032+2038	606
95X80	90-95/75-80	45-50	2035+2032+2038	610
100X80	95-100/75-80	47-52	2036+2032+2038	614
120X80	115-120/75-80	56-61	2037+2032+2038	633
Medida	Rangos	Apertura	Referencias	Puntos
90X90	85-90/85-90	47-52	2034+2034+2038	616
95X90	90-95/85-90	49-54	2035+2034+2038	620
100X90	95-100/85-90	50-55	2036+2034+2038	624
120X90	115-120/85-90	60-65	2037+2034+2038	643

Las aperturas son las mismas que en los frontales



Innovador sistema antivuelco



Rodamiento oculto



Doble asa metálica



Apertura soft close

## TWENTY frontal + lateral fijo de 6 mm



Descripción	Rango	Ref.	Puntos
Lateral fijo TWENTY 70	66,5-69,5	2013	182
Lateral fijo TWENTY 75	71,5-74,5	2014	189
Lateral fijo TWENTY 80	76,5-79,5	2015	198
Lateral fijo TWENTY 90	86,5-89,5	2016	214

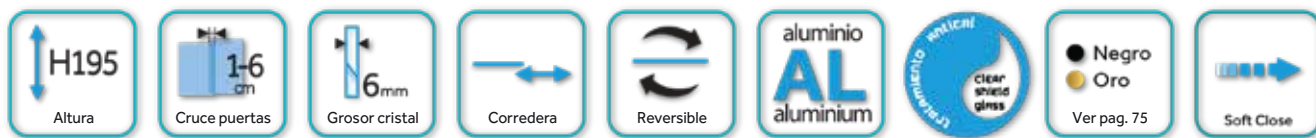

combinaciones frontales TWENTY + lateral fijo de 6 mm

Medida	Rangos	Referencias	Puntos	Medida	Rangos	Referencias	Puntos
120X70	115-120/66,5-69,5	2000+2021+2013	570	120X75	115-120/71,5-74,5	2000+2021+2014	577
125X70	120-125/66,5-69,5	2001+2021+2013	574	125X75	120-125/71,5-74,5	2001+2021+2014	581
130X70	125-130/66,5-69,5	2002+2021+2013	578	130X75	125-130/71,5-74,5	2002+2021+2014	585
135X70	130-135/66,5-69,5	2003+2021+2013	582	135X75	130-135/71,5-74,5	2003+2021+2014	589
140X70	135-140/66,5-69,5	2004+2021+2013	586	140X75	135-140/71,5-74,5	2004+2021+2014	593
145X70	140-145/66,5-69,5	2005+2021+2013	590	145X75	140-145/71,5-74,5	2005+2021+2014	597
150X70	145-150/66,5-69,5	2006+2021+2013	594	150X75	145-150/71,5-74,5	2006+2021+2014	601
155X70	150-155/66,5-69,5	2007+2022+2013	650	155X75	150-155/71,5-74,5	2007+2022+2014	657
160X70	155-160/66,5-69,5	2008+2022+2013	654	160X75	155-160/71,5-74,5	2008+2022+2014	661
165X70	160-165/66,5-69,5	2009+2022+2013	658	165X75	160-165/71,5-74,5	2009+2022+2014	665
170X70	165-170/66,5-69,5	2010+2022+2013	661	170X75	165-170/71,5-74,5	2010+2022+2014	668
175X70	170-175/66,5-69,5	2011+2022+2013	666	175X75	170-175/71,5-74,5	2011+2022+2014	673
180X70	175-180/66,5-69,5	2012+2022+2013	670	180X75	175-180/71,5-74,5	2012+2022+2014	677
Medida	Rangos	Referencias	Puntos	Medida	Rangos	Referencias	Puntos
120X80	115-120/76,5-79,5	2000+2021+2015	586	120X90	115-120/86,5-89,5	2000+2021+2016	602
125X80	120-125/76,5-79,5	2001+2021+2015	590	125X90	120-125/86,5-89,5	2001+2021+2016	606
130X80	125-130/76,5-79,5	2002+2021+2015	594	130X90	125-130/86,5-89,5	2002+2021+2016	610
135X80	130-135/76,5-79,5	2003+2021+2015	598	135X90	130-135/86,5-89,5	2003+2021+2016	614
140X80	135-140/76,5-79,5	2004+2021+2015	602	140X90	135-140/86,5-89,5	2004+2021+2016	618
145X80	140-145/76,5-79,5	2005+2021+2015	606	145X90	140-145/86,5-89,5	2005+2021+2016	622
150X80	145-150/76,5-79,5	2006+2021+2015	610	150X90	145-150/86,5-89,5	2006+2021+2016	626
155X80	150-155/76,5-79,5	2007+2022+2015	666	155X90	150-155/86,5-89,5	2007+2022+2016	682
160X80	155-160/76,5-79,5	2008+2022+2015	670	160X90	155-160/86,5-89,5	2008+2022+2016	686
165X80	160-165/76,5-79,5	2009+2022+2015	674	165X90	160-165/86,5-89,5	2009+2022+2016	690
170X80	165-170/76,5-79,5	2010+2022+2015	677	170X90	165-170/86,5-89,5	2010+2022+2016	693
175X80	170-175/76,5-79,5	2011+2022+2015	682	175X90	170-175/86,5-89,5	2011+2022+2016	698
180X80	175-180/76,5-79,5	2012+2022+2015	686	180X90	175-180/86,5-89,5	2012+2022+2016	702

Las aperturas son las mismas que en los frontales. \*Admite lateral fijo en ambos lados.



Laterales fijos a medida (más información en página 282)

Descripción	Referencias	Puntos	Cajonado
Lateral fijo a medida TWENTY hasta 40 cm	1375	212	+21
Lateral fijo a medida TWENTY de 40 hasta 80 cm	1376	291	+21
Lateral fijo a medida TWENTY de 80 hasta 120 cm	1377	361	+21

\*Plazo de entrega 15 días

# basic

"Inmejorable relación  
calidad-precio y amplitud de  
formatos, medidas y colores"







BASIC 1 fijo + 1 corredera





H196

Altura

1-6  
cm

Cruce puertas



6mm

Grosor cristal

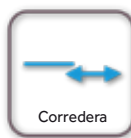

Corredera



Cierre burbuja

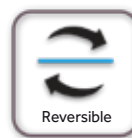

Reversible

aluminio  
AL  
aluminiumclear solid  
glass● Negro  
○ Blanco  
● Titanio  
Ver pag. 92

## frontales BASIC 1fijo + 1corredera

Medida	Apertura	TRANSPARENTE		FROST PLUS	
		Ref.	Puntos	Ref.	Puntos
95-100	36-41	5401	321	6401	348
100-105	36-41	5402	328	6402	355
105-110	41-46	5403	334	6403	361
110-115	41-46	5404	339	6404	368
115-120	46-51	5405	343	6405	375
120-125	46-51	5406	350	6406	382
125-130	51-56	5407	355	6407	389
130-135	51-56	5408	359	6408	394
135-140	56-61	5409	365	6409	401
140-145	56-61	5410	378	6410	416
145-150	61-66	5411	383	6411	423
150-155	61-66	5412	390	6412	430
155-160	61-66	5413	395	6413	437
160-165	61-66	5414	399	6414	441
165-170	66-71	5415	401	6415	460
170-175	66-71	5416	407	6416	468
175-180	66-71	5417	413	6417	475
180-190	66-71	*5455	440	*6455	507
190-200	66-71	*5456	451	*6456	522

\*El cruce de las referencias 5455, 5456, 6455 y 6456 será 1-11 cm.

Desglose por referencias/punto en página 293.

Descripción	Referencias	Puntos
Perfil de compensación +1,5 cm	5429	25
Pletina embellecedora 195x3,8 cm	0007	30



Nuevo guiador optimizado con pulsador liberador de hoja



Doble rodamiento regulable en nylon con antivuelco



Opción pletina embellecedora



Mamparas a medida y cristales especiales	TRANSPARENTE	FROST PLUS PARSOL / MATE
Altura hasta 195 cm	+45%	+60%
Altura de 195 hasta 220 cm	+75%	+90%

\*Plazo de entrega 15 días (más información en pág. 280)



Opción tirador	Ref.	Puntos
Extraplano 22x1,6x0,7 cm	1731	20
Largo 40x1,2x1,5 cm	1732	33

# BASIC SPAZIO 2 fijos + 2 correderas



## frontales BASIC SPAZIO 2fijos + 2correderas

Descripción	Rango	Apertura	Cruce	Referencias	Puntos
BASIC SPAZIO 140 (75+75)	132-142	46-56	1-6	5029+5029+5451	479
BASIC SPAZIO 150 (80+80)	142-152	56-66	1-6	5019+5019+5451	489
BASIC SPAZIO 160 (85+85)	152-162	54-64	1-6	5030+5030+5451	501
BASIC SPAZIO 170 (90+90)	162-172	66-76	1-6	5020+5020+5451	511
BASIC SPAZIO 180 (95+95)	172-182	62-72	1-6	5031+5031+5454	521
BASIC SPAZIO 190 (100+100)	182-192	76-86	1-6	5021+5021+5454	525
BASIC SPAZIO 200 (100+100)	190-200	76-86	1-6	5001+5001+5454	531
BASIC SPAZIO 210 (105+105)	200-210	76-86	1-6	5002+5002+5454	545

Se puede combinar con lateral fijo (ver pág. 30), usando ref. 0182 (indicar mano). El rango aumenta 1,2 cm en uno de los lados.

\*Desglose por referencias/punto en página 293.

Descripción	Ref.	Puntos
Perfil de compensación +1,5 cm	5429	25
Perfil unión fijo-fijo (indicar mano), ver pág. 167	0182	40

Mamparas a medida y cristales especiales	TRANSP.	FROST PLUS PARSOL /MATE
Altura hasta 195 cm	+45%	+60%
Altura 195 hasta 220 cm	+75%	+90%

\*Plazo de entrega 15 días (más información en pág. 280)

# BASIC SPAZIO FROST PLUS 2 fijos + 2 correderas



## frontales BASIC SPAZIO FROST PLUS 2fijos + 2correderas

Descripción	Rango	Apertura	Cruce	Referencias	Puntos
BASIC SPAZIO FROST PLUS 140 (75+75)	132-142	46-56	1-6	6029+6029+5451	523
BASIC SPAZIO FROST PLUS 150 (80+80)	142-152	56-66	1-6	6019+6019+5451	531
BASIC SPAZIO FROST PLUS 160 (85+85)	152-162	54-64	1-6	6030+6030+5451	543
BASIC SPAZIO FROST PLUS 170 (90+90)	162-172	66-76	1-6	6020+6020+5451	553
BASIC SPAZIO FROST PLUS 180 (95+95)	172-182	62-72	1-6	6031+6031+5454	567
BASIC SPAZIO FROST PLUS 190 (100+100)	182-192	76-86	1-6	6021+6021+5454	579
BASIC SPAZIO FROST PLUS 200 (100+100)	190-200	76-86	1-6	6001+6001+5454	585
BASIC SPAZIO FROST PLUS 210 (105+105)	200-210	76-86	1-6	6002+6002+5454	599

Se puede combinar con lateral fijo (ver pág. 30), usando ref. 0182 (indicar mano). El rango aumenta 1,2 cm en uno de los lados.

\*Desglose por referencias/punto en página 293.

Descripción	Ref.	Puntos
Perfil de compensación +1,5 cm	5429	25
Perfil unión fijo-fijo (indicar mano), ver pág. 167	0182	40

Mamparas a medida y cristales especiales	TRANSP.	FROST PLUS PARSOL /MATE
Altura hasta 195 cm	+45%	+60%
Altura 195 hasta 220 cm	+75%	+90%

\*Plazo de entrega 15 días (más información en pág. 280)

## BASIC FIJO + PUERTA + FIJO



Se puede combinar con el lateral fijo de la página 30, usando ref. 0182 (indicar mano). El rango aumenta 1,2 cm en uno de los lados. Desglose por referencias/punto en página 293.



Gomas transparentes anti-coloración



Doble rodamiento regulable en nylon con antivuelco



Tirador metálico



Nuevo guiador optimizado con pulsador liberador de hoja

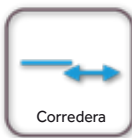

Ver pag. 81

**PASO 1: Seleccionar medida de la PERFILERÍA**

**PASO 2: Seleccionar medida/decorado FIJO EN LÍNEA**

**PASO 3: Seleccionar medida/decorado de los FRONTALES**

**Rango = (Rango Min/Max frontal + Medida fijo en línea)**

## PASO 1: PERFILERÍA

Descripción	Ref.	Puntos
Accesorios frontal hasta 140 cm (2 rodamientos)	5434	176
Accesorios frontal hasta 180 cm (2 rodamientos)	5438	184
Accesorios frontal hasta 200 cm (3 rodamientos)	5446	201

## PASO 2: FIJOS EN LÍNEA

Medida fijo	TRANSPARENTE		FROST PLUS	
	Ref.	Puntos	Ref.	Puntos
Fijo de 30 cm + magnético unión	5018F+5467	112	6018F+5467	128
Fijo de 35 cm + magnético unión	5019F+5467	119	6019F+5467	135
Fijo de 40 cm + magnético unión	5020F+5467	123	6020F+5467	139
Fijo de 45 cm + magnético unión	5021F+5467	133	6021F+5467	149
Fijo de 52 cm + magnético unión	5002F+5467	139	6002F+5467	154
Fijo de 55 cm + magnético unión	5022F+5467	146	6022F+5467	161
Fijo de 57 cm + magnético unión	5004F+5467	150	6004F+5467	165

## PASO 3: FRONTALES

Descripción	Rangos (cm)	TRANSPARENTE		FROST PLUS	
		Ref.	Puntos	Ref.	Puntos
Cristal fijo + puerta frontal de 100	95-100	5001	145	6001	172
Cristal fijo + puerta frontal de 105	100-105	5002	152	6002	179
Cristal fijo + puerta frontal de 110	105-110	5003	158	6003	185
Cristal fijo + puerta frontal de 115	110-115	5004	163	6004	192
Cristal fijo + puerta frontal de 120	115-120	5005	167	6005	199
Cristal fijo + puerta frontal de 125	120-125	5006	174	6006	206
Cristal fijo + puerta frontal de 130	125-130	5007	179	6007	213
Cristal fijo + puerta frontal de 135	130-135	5008	183	6008	218
Cristal fijo + puerta frontal de 140	135-140	5009	189	6009	225
Cristal fijo + puerta frontal de 145	140-145	5010	194	6010	232
Cristal fijo + puerta frontal de 150	145-150	5011	199	6011	239
Cristal fijo + puerta frontal de 155	150-155	5012	206	6012	246
Cristal fijo + puerta frontal de 160	155-160	5013	211	6013	253
Cristal fijo + puerta frontal de 165	160-165	5014	215	6014	257
Cristal fijo + puerta frontal de 170	165-170	5015L	217	6015L	276
Cristal fijo + puerta frontal de 175	170-175	5016L	223	6016L	284
Cristal fijo + puerta frontal de 180	175-180	5017L	229	6017L	291
Cristal fijo + puerta frontal de 190	180-190	5023L	239	6023L	306
Cristal fijo + puerta frontal de 200	190-200	5024L	250	6024L	321



### Fijos en línea a medida + magnético

Descripción	TRANSPARENTE		FROST PLUS		Cajonado
	Ref.	Puntos	Ref.	Puntos	
medida hasta 40 cm	1370	190	1372	330	+21
medida de 40 hasta 80 cm	1371	225	1373	365	+21

\*Plazo de entrega 15 días

# BASIC angular al vértice



Mamparas a medida y cristales especiales	TRANSPARENTE	FROST PLUS PARSOL / MATE	CAJONADO
Altura hasta 195 cm	+45%	+60%	+21
Altura de 195 hasta 220 cm	+75%	+90%	+21

\*Plazo de entrega 15 días (más información en pág. 280)

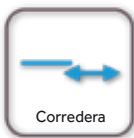

combinaciones angular **BASIC** apertura al vértice

Medida	Rangos	Apertura	TRANSPARENTE		FROST PLUS	
			Referencias	Puntos	Referencias	Puntos
70x70	65-70/65-70	34-37	5018+5018+5423	477	6018+6018+5423	519
75x70	70-75/65-70	36-39	5029+5018+5423	482	6029+6018+5423	525
80x70	75-80/65-70	38-41	5019+5018+5423	487	6019+6018+5423	529
85x70	80-85/65-70	40-43	5030+5018+5423	493	6030+6018+5423	535
90x70	85-90/65-70	41-45	5020+5018+5423	498	6020+6018+5423	540
95x70	90-95/65-70	43-47	5031+5018+5423	501	6031+6018+5423	545
100x70	95-100/65-70	46-49	5021+5018+5423	503	6021+6018+5423	551
110x70	105-109/65-70	47-50	5002+5018+5423	513	6002+6018+5423	561
120x70	115-120/65-70	50-53	5022+5018+5423	524	6022+6018+5423	582
130x70	125-129/65-70	55-58	5006+5018+5424	545	6006+6018+5424	598
140x70	135-139/65-70	59-62	5008+5018+5424	554	6008+6018+5424	610
Medida	Rangos	Apertura	Referencias	Puntos	Referencias	Puntos
75x75	70-75/70-75	38-41	5029+5029+5423	487	6029+6029+5423	531
80x75	75-80/70-75	40-43	5019+5029+5423	492	6019+6029+5423	535
85x75	80-85/70-75	42-45	5030+5029+5423	498	6030+6029+5423	541
90x75	85-90/70-75	45-48	5020+5029+5423	503	6020+6029+5423	546
95x75	90-95/70-75	47-50	5031+5029+5423	506	6031+6029+5423	551
100x75	95-100/70-75	48-51	5021+5029+5423	508	6021+6029+5423	557
110x75	105-109/70-75	49-52	5002+5029+5423	518	6002+6029+5423	567
120x75	115-120/70-75	52-55	5022+5029+5423	529	6022+6029+5423	588
130x75	125-129/70-75	57-60	5006+5029+5424	550	6006+6029+5424	604
140x75	135-139/70-75	61-64	5008+5029+5424	559	6008+6029+5424	616
Medida	Rangos	Apertura	Referencias	Puntos	Referencias	Puntos
80x80	75-80/75-80	41-44	5019+5019+5423	497	6019+6019+5423	539
85x80	80-85/75-80	43-46	5030+5019+5423	503	6030+6019+5423	545
90x80	85-90/75-80	45-48	5020+5019+5423	508	6020+6019+5423	550
95x80	90-95/75-80	47-50	5031+5019+5423	511	6031+6019+5423	555
100x80	95-100/75-80	49-52	5021+5019+5423	513	6021+6019+5423	561
110x80	105-109/75-80	50-53	5002+5019+5423	523	6002+6019+5423	571
120x80	115-120/75-80	53-56	5022+5019+5423	534	6022+6019+5423	592
130x80	125-129/75-80	57-60	5006+5019+5424	555	6006+6019+5424	608
140x80	135-139/75-80	62-65	5008+5019+5424	564	6008+6019+5424	620
Medida	Rangos	Apertura	Referencias	Puntos	Referencias	Puntos
85x90	80-85/85-90	46-49	5030+5020+5423	514	6030+6020+5423	556
90x90	85-90/85-90	48-51	5020+5020+5423	519	6020+6020+5423	561
95x90	90-95/85-90	50-53	5031+5020+5423	522	6031+6020+5423	566
100x90	95-100/85-90	52-55	5021+5020+5423	524	6021+6020+5423	572
110x90	105-109/85-90	53-56	5002+5020+5423	534	6002+6020+5423	582
120x90	115-120/85-90	57-62	5022+5020+5423	545	6022+6020+5423	603
130x90	125-129/85-90	60-63	5006+5020+5424	566	6006+6020+5424	619
140x90	135-139/85-90	64-67	5008+5020+5424	575	6008+6020+5424	631

\*Desglose por referencias/punto en página 293.

Descripción	Referencias	Puntos
Perfil de compensación +1,5 cm	5429	25

# BASIC frontal + lateral fijo de 8 mm



Descripción	Rango	TRANSPARENTE		FROST PLUS	
		Ref.	Puntos	Ref.	Puntos
lateral fijo BASIC 70	67-69	5425	208	6425	230
lateral fijo BASIC 75	72-74	5457	212	6457	240
lateral fijo BASIC 80	77-79	5426	219	6426	247
lateral fijo BASIC 90	87-89	5427	231	6427	259



## Laterales fijos a medida

### Descripción

medida hasta 40 cm

medida de 40 hasta 80 cm

medida de 80 hasta 120 cm

Descripción	TRANSPARENTE		FROST PLUS		Cajonado
	Ref.	Puntos	Ref.	Puntos	
medida hasta 40 cm	1350	206	1350+1312	328	+21
medida de 40 hasta 80 cm	1334	286	1334+1313	408	+21
medida de 80 hasta 120 cm	1335	356	1335+1315	478	+21

\*Plazo de entrega 15 días

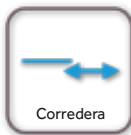

combinaciones frontales **BASIC** + lateral fijo de 8 mm

Medida	Rangos	Apertura	TRANSPARENTE		FROST PLUS	
			Referencias	Puntos	Referencias	Puntos
100x70	95-100/67-69	38-43	5401+5425	529	6401+6425	578
110x70	105-110/67-69	43-48	5403+5425	542	6403+6425	591
120x70	115-120/67-69	48-53	5405+5425	551	6405+6425	605
130x70	125-130/67-69	53-58	5407+5425	563	6407+6425	619
140x70	135-140/67-69	58-63	5409+5425	573	6409+6425	631
150x70	145-150/67-69	63-68	5411+5425	591	6411+6425	653
160x70	155-160/67-69	63-68	5413+5425	603	6413+6425	667
170x70	165-170/67-69	68-73	5415+5425	609	6415+6425	690
180x70	175-180/67-69	68-73	5417+5425	621	6417+6425	705
100x75	95-100/72-74	38-43	5401+5457	533	6401+6457	588
110x75	105-110/72-74	43-48	5403+5457	546	6403+6457	601
120x75	115-120/72-74	48-53	5405+5457	555	6405+6457	615
130x75	125-130/72-74	53-58	5407+5457	567	6407+6457	629
140x75	135-140/72-74	58-63	5409+5457	577	6409+6457	641
150x75	145-150/72-74	63-68	5411+5457	595	6411+6457	663
160x75	155-160/72-74	63-68	5413+5457	607	6413+6457	677
170x75	165-170/72-74	68-73	5415+5457	613	6415+6457	700
180x75	175-180/72-74	68-73	5417+5457	625	6417+6457	715
100x80	95-100/77-79	38-43	5401+5426	540	6401+6426	595
110x80	105-110/77-79	43-48	5403+5426	553	6403+6426	608
120x80	115-120/77-79	48-53	5405+5426	562	6405+6426	622
130x80	125-130/77-79	53-58	5407+5426	574	6407+6426	636
140x80	135-140/77-79	58-63	5409+5426	584	6409+6426	648
150x80	145-150/77-79	63-68	5411+5426	602	6411+6426	670
160x80	155-160/77-79	63-68	5413+5426	614	6413+6426	684
170x80	165-170/77-79	68-73	5415+5426	620	6415+6426	707
180x80	175-180/77-79	68-73	5417+5426	632	6417+6426	722
100x90	95-100/87-89	38-43	5401+5427	552	6401+6427	607
110x90	105-110/87-89	43-48	5403+5427	565	6403+6427	620
120x90	115-120/87-89	48-53	5405+5427	574	6405+6427	634
130x90	125-130/87-89	53-58	5407+5427	586	6407+6427	648
140x90	135-140/87-89	58-63	5409+5427	596	6409+6427	660
150x90	145-150/87-89	63-68	5411+5427	614	6411+6427	682
160x90	155-160/87-89	63-68	5413+5427	626	6413+6427	696
170x90	165-170/87-89	68-73	5415+5427	632	6415+6427	719
180x90	175-180/87-89	68-73	5417+5427	644	6417+6427	734

Se pueden hacer combinaciones con medidas intermedias de frontales y hasta 2 metros.

Descripción	Referencias	Puntos
Perfil de compensación +1,5 cm (sólo para los frontales)	5429	25
Opción perfil unión fijo-fijo (indicar mano), ver pag. 167	0182	40

# BASIC FREE

Mayor paso de entrada / Menor precio / Misma función



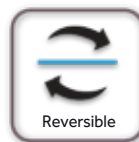
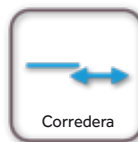

## PASO 1: Seleccionar medida de la perfilera

## PASO 2: Seleccionar medida de los cristales

### PASO 1: PERFILERÍA

Descripción	Ref.	Puntos
Perfilería y accesorios hasta 140 + KIT FREE	5434+5447	191
Perfilería y accesorios hasta 180 + KIT FREE	5438+5447	199
Perfilería y accesorios hasta 200 + KIT FREE	5446+5447	216

Desglose por referencias/punto en página 293.

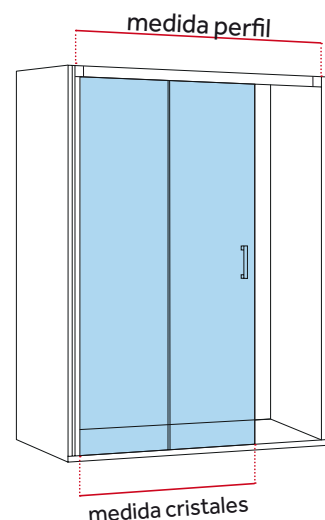

### PASO 2: CRISTALES

Descripción	Rangos	TRANSPARENTE		FROST PLUS	
		Ref.	Puntos	Ref.	Puntos
BASIC FREE 100	95-100	5001	145	6001	172
BASIC FREE 105	100-105	5002	152	6002	179
BASIC FREE 110	105-110	5003	158	6003	185
BASIC FREE 115	110-115	5004	163	6004	192
BASIC FREE 120	115-120	5005	167	6005	199
BASIC FREE 125	120-125	5006	174	6006	206
BASIC FREE 130	125-130	5007	179	6007	213
BASIC FREE 135	130-135	5008	183	6008	218
BASIC FREE 140	135-140	5009	189	6009	225
BASIC FREE 145	140-145	5010	194	6010	232
BASIC FREE 150	145-150	5011	199	6011	239
BASIC FREE 155	150-155	5012	206	6012	246
BASIC FREE 160	155-160	5013	211	6013	253
BASIC FREE 165	160-165	5014	215	6014	257
BASIC FREE 170	165-170	5015L	217	6015L	276
BASIC FREE 175	170-175	5016L	223	6016L	284
BASIC FREE 180	175-180	5017L	229	6017L	291
BASIC FREE 190	180-190	5023L	239	6023L	306
BASIC FREE 200	190-200	5024L	250	6024L	321



Perfilería en aluminio pulido con stopper



Doble rodamiento regulable en nylon con antivuelco



Opción pletina embellecedora



Nuevo guiador optimizado con pulsador liberador de hoja

# BASIC FREE ANGULAR

Mayor paso de entrada / Menor precio / Misma función



Mamparas a medida y cristales especiales	TRANSPARENTE	FROST PLUS PARSOL / MATE	CAJONADO
Altura hasta 195 cm	+45%	+60%	+21
Altura de 195 hasta 220 cm	+75%	+90%	+21

\*Plazo de entrega 15 días (más información en pág. 280)

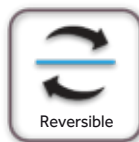
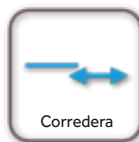
combinaciones angular **BASIC FREE**

		TRANSPARENTE		FROST PLUS	
Medida	Rangos	Referencias	Puntos	Referencias	Puntos
70x70	65-70/65-70	5018+5423+5447	376	6018+5423+5447	397
75x70	70-75/65-70	5029+5423+5447	381	6029+5423+5447	403
80x70	75-80/65-70	5019+5423+5447	386	6019+5423+5447	407
85x70	80-85/65-70	5030+5423+5447	392	6030+5423+5447	413
90x70	85-90/65-70	5020+5423+5447	397	6020+5423+5447	418
95x70	90-95/65-70	5031+5423+5447	400	6031+5423+5447	423
100x70	95-100/65-70	5021+5423+5447	402	6021+5423+5447	429
110x70	105-109/65-70	5002+5423+5447	412	6002+5423+5447	439
120x70	115-120/65-70	5022+5423+5447	423	6022+5423+5447	460
130x70	125-129/65-70	5006+5424+5447	444	6006+5424+5447	476
140x70	135-139/65-70	5008+5424+5447	453	6008+5424+5447	488
Medida	Rangos	Referencias	Puntos	Referencias	Puntos
75x75	70-75/70-75	5029+5423+5447	381	6029+5423+5447	403
80x75	75-80/70-75	5019+5423+5447	386	6019+5423+5447	407
85x75	80-85/70-75	5030+5423+5447	392	6030+5423+5447	413
90x75	85-90/70-75	5020+5423+5447	397	6020+5423+5447	418
95x75	90-95/70-75	5031+5423+5447	400	6031+5423+5447	423
100x75	95-100/70-75	5021+5423+5447	402	6021+5423+5447	429
110x75	105-109/70-75	5002+5423+5447	412	6002+5423+5447	439
120x75	115-120/70-75	5022+5423+5447	423	6022+5423+5447	460
130x75	125-129/70-75	5006+5424+5447	444	6006+5424+5447	476
140x75	135-139/70-75	5008+5424+5447	453	6008+5424+5447	488
Medida	Rangos	Referencias	Puntos	Referencias	Puntos
80x80	75-80/75-80	5019+5423+5447	386	6019+5423+5447	407
85x80	80-85/75-80	5030+5423+5447	392	6030+5423+5447	413
90x80	85-90/75-80	5020+5423+5447	397	6020+5423+5447	418
95x80	90-95/75-80	5031+5423+5447	400	6031+5423+5447	423
100x80	95-100/75-80	5021+5423+5447	402	6021+5423+5447	429
110x80	105-109/75-80	5002+5423+5447	412	6002+5423+5447	439
120x80	115-120/75-80	5022+5423+5447	423	6022+5423+5447	460
130x80	125-129/75-80	5006+5424+5447	444	6006+5424+5447	476
140x80	135-139/75-80	5008+5424+5447	453	6008+5424+5447	488
Medida	Rangos	Referencias	Puntos	Referencias	Puntos
90x90	85-90/85-90	5020+5423+5447	397	6020+5423+5447	418
95x90	90-95/85-90	5031+5423+5447	400	6031+5423+5447	423
100x90	95-100/85-90	5021+5423+5447	402	6021+5423+5447	429
110x90	105-109/85-90	5002+5423+5447	412	6002+5423+5447	439
120x90	115-120/85-90	5022+5423+5447	423	6022+5423+5447	460
130x90	125-129/85-90	5006+5424+5447	444	6006+5424+5447	476
140x90	135-139/85-90	5008+5424+5447	453	6008+5424+5447	488

\*Desglose por referencias/punto en página 293.

Descripción	Referencias	Puntos
Perfil de compensación +1,5 cm	5429	25



# kenna

## 8mm

"Diseño vanguardista  
con ausencia de perfilería  
manteniendo la corredera  
interior"







KENNA 1 fijo + 1 corredera



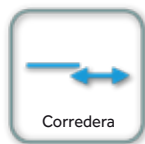

## Frontales KENNA 1fijo + 1corredera

Descripción	Rango	Apertura	Ref.	Puntos
Frontal ducha KENNA 100	95-100	34-39	6530	426
Frontal ducha KENNA 105	100-105	37-42	6531	441
Frontal ducha KENNA 110	105-110	39-44	6532	442
Frontal ducha KENNA 115	110-115	42-47	6533	444
Frontal ducha KENNA 120	115-120	44-49	6534	457
Frontal ducha KENNA 125	120-125	47-52	6535	465
Frontal ducha KENNA 130	125-130	49-54	6536	473
Frontal ducha KENNA 135	130-135	52-57	6537	481
Frontal ducha KENNA 140	135-140	52-57	6538	496
Frontal ducha KENNA 145	140-145	57-62	6539	501
Frontal ducha KENNA 150	145-150	57-62	6540	513
Frontal ducha KENNA 155	150-155	62-67	6541	518
Frontal ducha KENNA 160	155-160	64-69	6542	526
Frontal ducha KENNA 165	160-165	64-69	6543	534
Frontal ducha KENNA 170	165-170	64-69	6544	541
Frontal ducha KENNA 175	170-175	64-69	6545	550
Frontal ducha KENNA 180	175-180	64-69	6546	559



# KENNA FREE 1 fijo+1 corredera



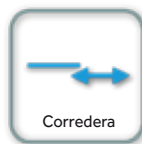

## Frontales KENNA FREE 1fijo + 1corredera

Descripción	Rango	Referencia	Puntos
Frontal ducha KENNA free <b>100</b>	93-98	<b>6530</b>	<b>426</b>
Frontal ducha KENNA free <b>105</b>	98-103	<b>6531</b>	<b>441</b>
Frontal ducha KENNA free <b>110</b>	103-108	<b>6532</b>	<b>442</b>
Frontal ducha KENNA free <b>115</b>	108-113	<b>6533</b>	<b>444</b>
Frontal ducha KENNA free <b>120</b>	113-118	<b>6534</b>	<b>457</b>
Frontal ducha KENNA free <b>125</b>	118-123	<b>6535</b>	<b>465</b>
Frontal ducha KENNA free <b>130</b>	123-128	<b>6536</b>	<b>473</b>
Frontal ducha KENNA free <b>135</b>	128-133	<b>6537</b>	<b>481</b>
Frontal ducha KENNA free <b>140</b>	133-138	<b>6538</b>	<b>496</b>
Frontal ducha KENNA free <b>145</b>	138-143	<b>6539</b>	<b>501</b>
Frontal ducha KENNA free <b>150</b>	143-148	<b>6540</b>	<b>513</b>
Frontal ducha KENNA free <b>155</b>	148-153	<b>6541</b>	<b>518</b>
Frontal ducha KENNA free <b>160</b>	153-158	<b>6542</b>	<b>526</b>
Frontal ducha KENNA free <b>165</b>	158-163	<b>6543</b>	<b>534</b>
Frontal ducha KENNA free <b>170</b>	163-168	<b>6544</b>	<b>541</b>
Frontal ducha KENNA free <b>175</b>	168-173	<b>6545</b>	<b>550</b>
Frontal ducha KENNA free <b>180</b>	173-178	<b>6546</b>	<b>559</b>



Barra articulable en acero



Doble asa metálica



Rodamiento integrado en hoja



Opción barra paralela



## KENNA frontal + lateral fijo de 8 mm



Descripción	Rango	Ref.	Puntos
Lateral fijo KENNA 70	67-69	6547	235
Lateral fijo KENNA 75	72-74	6548	240
Lateral fijo KENNA 80	77-79	6549	249
Lateral fijo KENNA 90	87-89	6550	258





H195

Altura

3-8  
cm

Cruce puertas



8mm

Grosor cristal

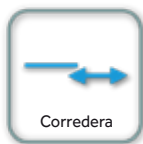

Corredera



Magnético



Reversible

aluminio  
AL  
aluminiumtratamiento  
antical  
clear  
shield  
glass

## Combinaciones frontales KENNA + lateral fijo de 8 mm

Medida	Rangos	Referencias	Puntos	Medida	Rangos	Referencias	Puntos
100x70	95-100/67-69	6530+6547	661	100x75	95-100/72-74	6530+6548	666
110x70	105-110/67-69	6532+6547	677	110x75	105-110/72-74	6532+6548	682
120x70	115-120/67-69	6534+6547	692	120x75	115-120/72-74	6534+6548	697
130x70	125-130/67-69	6536+6547	708	130x75	125-130/72-74	6536+6548	713
140x70	135-140/67-69	6538+6547	731	140x75	135-140/72-74	6538+6548	736
150x70	145-150/67-69	6540+6547	748	150x75	145-150/72-74	6540+6548	753
160x70	155-160/67-69	6542+6547	761	160x75	155-160/72-74	6542+6548	766
170x70	165-170/67-69	6544+6547	776	170x75	165-170/72-74	6544+6548	781
180x70	175-180/67-69	6546+6547	794	180x75	175-180/72-74	6546+6548	799
Medida	Rangos	Referencias	Puntos	Medida	Rangos	Referencias	Puntos
100x80	95-100/77-79	6530+6549	675	100x90	95-100/87-89	6530+6550	684
110x80	105-110/77-79	6532+6549	691	110x90	105-110/87-89	6532+6550	700
120x80	115-120/77-79	6534+6549	706	120x90	115-120/87-89	6534+6550	715
130x80	125-130/77-79	6536+6549	722	130x90	125-130/87-89	6536+6550	731
140x80	135-140/77-79	6538+6549	745	140x90	135-140/87-89	6538+6550	754
150x80	145-150/77-79	6540+6549	762	150x90	145-150/87-89	6540+6550	771
160x80	155-160/77-79	6542+6549	775	160x90	155-160/87-89	6542+6550	784
170x80	165-170/77-79	6544+6549	790	170x90	165-170/87-89	6544+6550	799
180x80	175-180/77-79	6546+6549	808	180x90	175-180/87-89	6546+6550	817

Se pueden hacer combinaciones con medidas intermedias de frontales y hasta 175 cm. La apertura es +2 cm que en el frontal.



Doble asa metálica



Rodamiento integrado en hoja



Barra guía en acero



### Laterales fijos a medida (más información en página 282)

Descripción	Ref.	Puntos	Cajonado
medida hasta 40 cm	1365	279	+21
medida de 40 hasta 80 cm	1366	364	+21
medida de 80 hasta 120 cm	1367	434	+21

\*Plazo de entrega 15 días

# vitro

"Protagonismo del cristal con su innovador diseño"





# VITRO 1 fijo + 1 corredera



	TRANSPARENTE	FROST PLUS PARSOL / MATE	CAJONADO
Mamparas a medida y cristales especiales	+45%	+60%	+21

\*Plazo de entrega 15 días (más información en pág. 280)



H196

Altura

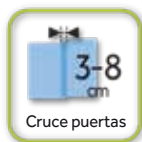

3-8  
cm

Cruce puertas



6mm

Grosor cristal

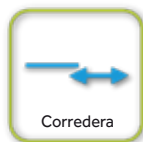

Corredera



Cierre burbuja



Reversible



aluminio  
**AL**  
aluminium



antical  
clear  
shield  
glass

## Frontales VITRO

Descripción	Rango	Apertura	Referencias	Puntos
Frontal ducha VITRO 100	95-100	36-41	5501	402
Frontal ducha VITRO 105	100-105	36-41	5502	409
Frontal ducha VITRO 110	105-110	41-46	5503	415
Frontal ducha VITRO 115	110-115	41-46	5504	420
Frontal ducha VITRO 120	115-120	46-51	5505	424
Frontal ducha VITRO 125	120-125	46-51	5506	431
Frontal ducha VITRO 130	125-130	51-56	5507	436
Frontal ducha VITRO 135	130-135	51-56	5508	440
Frontal ducha VITRO 140	135-140	56-61	5509	446
Frontal ducha VITRO 145	140-145	56-61	5510	461
Frontal ducha VITRO 150	145-150	61-66	5511	466
Frontal ducha VITRO 155	150-155	61-66	5512	473
Frontal ducha VITRO 160	155-160	61-66	5513	478
Frontal ducha VITRO 165	160-165	61-66	5514	482
Frontal ducha VITRO 170	165-170	66-71	5515	484
Frontal ducha VITRO 175	170-175	66-71	5516	490
Frontal ducha VITRO 180	175-180	66-71	5517	496
Perfil de compensación +1,5 cm			5429	25
Opción barra inox paralela hasta 2 m			5546	65
Pletina embellecedora 195x3,8 cm			0007	30

Desglose por referencias/punto en página 293.

### OPCIÓN VITRO FREE



El rango pierde 2 cm

### OPCIÓN BARRA PARALELA ref 5546



## VITRO SPAZIO 2 fijos + 2 correderas







H196

Altura

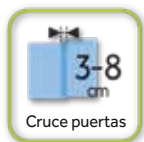

3-8  
cm

Cruce puertas



6mm

Grosor cristal



Corredera



Magnético



Reversible



aluminio  
**AL**  
aluminium



tratamiento antical  
clear  
shield  
glass

## Frontales VITRO SPAZIO 2fijos+2correderas

Descripción	Rango	Apertura	Referencias	Puntos
VITRO SPAZIO 140 (75+75)	130-140	44-54	5029+5029+5552	639
VITRO SPAZIO 150 (80+80)	140-150	54-64	5019+5019+5552	649
VITRO SPAZIO 160 (85+85)	150-160	62-72	5030+5030+5552	661
VITRO SPAZIO 170 (90+90)	160-170	54-74	5020+5020+5552	671
VITRO SPAZIO 180 (95+95)	170-180	70-80	5031+5031+5554	687
VITRO SPAZIO 190 (100+100)	180-190	64-84	5021+5021+5554	691
VITRO SPAZIO 200 (100+100)	188-198	74-84	5001+5001+5554	697
VITRO SPAZIO 210 (105+105)	198-208	74-84	5002+5002+5554	711
Pletina embellecedora 195x3,8 cm			0007	30

Se puede combinar con el lateral fijo de la página 52 usando ref. 0182. El rango aumenta 1,2 cm en uno de los lados.  
Desglose por referencias/punto en página 293.



Rodamiento oculto sobre guía



Reducción dist. entre cristales



Brazo orientable



Mamparas a medida  
y cristales especiales

TRANSPARENTE

+45%

FROST PLUS  
PARSOL / MATE

+60%

CAJONADO

+21

\*Plazo de entrega 15 días (más información en pág. 280)

## VITRO angular al vértice



Guiador y soporte fijo en acero



Tirador metálico



Nuevo rod. minimal blindado



Reducción dist. entre cristales

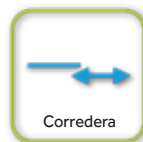
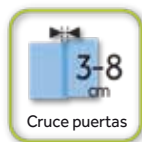

## Combinaciones VITRO apertura al vértice

Medidas	Rangos	Apertura	Referencias	Puntos
70X67	62-67/62-67	32-35	5018+5018+5523	615
80X67	72-77/62-67	36-39	5019+5018+5523	625
90X67	82-87/62-67	40-43	5020+5018+5523	636
100X67	92-97/62-67	43-46	5021+5018+5523	641
110X67	105-110/62-67	47-50	5003+5018+5523	657
120X67	112-117/62-67	49-52	5022+5018+5523	662
130X67	125-130/62-67	50-53	5007+5018+5524	688
140X67	135-140/62-67	55-58	5009+5018+5524	698
Medidas	Rangos	Apertura	Referencias	Puntos
80X72	77-82/67-72	39-42	5030+5029+5523	636
90X72	87-92/67-72	42-45	5031+5029+5523	644
100X72	95-100/67-72	46-49	5001+5029+5523	649
110X72	105-110/67-72	48-51	5003+5029+5523	662
120X72	112-117/67-72	50-53	5022+5029+5523	667
130X72	125-130/67-72	51-54	5007+5029+5524	693
140X72	135-140/67-72	56-59	5009+5029+5524	703
Medidas	Rangos	Apertura	Referencias	Puntos
75X77	72-77/72-77	38-41	5019+5019+5523	635
80X77	77-82/72-77	40-43	5030+5019+5523	641
90X77	87-92/72-77	44-47	5031+5019+5523	649
100X77	95-100/72-77	48-51	5001+5019+5523	654
110X77	105-110/72-77	50-53	5003+5019+5523	667
120X77	112-117/72-77	51-54	5022+5019+5523	672
130X77	125-130/72-77	56-59	5007+5019+5524	698
140X77	135-140/72-77	59-62	5009+5019+5524	708
Medidas	Rangos	Apertura	Referencias	Puntos
80X82	77-82/77-82	42-45	5030+5030+5523	647
90X82	87-92/77-82	46-49	5031+5030+5523	655
100X82	95-100/77-82	50-53	5001+5030+5523	660
110X82	105-110/77-82	51-54	5003+5030+5523	673
120X82	112-117/77-82	56-59	5022+5030+5523	678
130X82	125-130/77-82	59-62	5007+5030+5524	704
140X82	135-140/77-82	61-64	5009+5030+5524	714
Medidas	Rangos	Apertura	Referencias	Puntos
90X92	87-92/87-92	46-49	5031+5031+5523	663
100X92	95-100/87-92	50-53	5001+5031+5523	668
110X92	105-110/87-92	51-54	5003+5031+5523	681
120X92	112-117/87-92	56-59	5022+5031+5523	686
130X92	125-130/87-92	59-62	5007+5031+5524	712
140X92	135-140/87-92	63-66	5009+5031+5524	722
Pletina embellecedora 195x3,8 cm			0007	30

Se pueden combinar frontales de medidas intermedias, rango +2 cm. Desglose por referencias/punto en página 293.

## VITRO frontal + lateral fijo de 8 mm



Descripción	Rango	Referencias	Puntos
Lateral fijo VITRO 70	67-69	5525	258
Lateral fijo VITRO 75	72-74	5557	262
Lateral fijo VITRO 80	77-79	5526	269
Lateral fijo VITRO 90	87-89	5527	281



H196

Altura

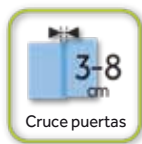

3-8 cm

Cruce puertas



6mm

Grosor cristal

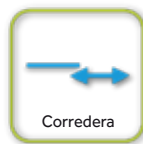

Corredera



Magnético



Reversible



aluminio  
AL  
aluminium



Tratamiento  
antirain  
CLEAR  
shield  
GLASS

### Combinaciones frontales VITRO + lateral fijo de 8 mm

Medidas	Rangos	Referencias	Puntos	Medidas	Rangos	Referencias	Puntos
100x70	95-100/67-69	5501+5525	660	100x75	95-100/72-74	5501+5557	664
110x70	105-110/67-69	5503+5525	673	110x75	105-110/72-74	5503+5557	677
120x70	115-120/67-69	5505+5525	682	120x75	115-120/72-74	5505+5557	686
130x70	125-130/67-69	5507+5525	694	130x75	125-130/72-74	5507+5557	698
140x70	135-140/67-69	5509+5525	704	140x75	135-140/72-74	5509+5557	708
150x70	145-150/67-69	5511+5525	724	150x75	145-150/72-74	5511+5557	728
160x70	155-160/67-69	5513+5525	736	160x75	155-160/72-74	5513+5557	740
170x70	165-170/67-69	5515+5525	742	170x75	165-170/72-74	5515+5557	746
180x70	175-180/67-69	5517+5525	754	180x75	175-180/72-74	5517+5557	758
Medidas	Rangos	Referencias	Puntos	Medidas	Rangos	Referencias	Puntos
100x80	95-100/77-79	5501+5526	671	100x90	95-100/87-89	5501+5527	683
110x80	105-110/77-79	5503+5526	684	110x90	105-110/87-89	5503+5527	696
120x80	115-120/77-79	5505+5526	693	120x90	115-120/87-89	5505+5527	705
130x80	125-130/77-79	5507+5526	705	130x90	125-130/87-89	5507+5527	717
140x80	135-140/77-79	5509+5526	715	140x90	135-140/87-89	5509+5527	727
150x80	145-150/77-79	5511+5526	735	150x90	145-150/87-89	5511+5527	747
160x80	155-160/77-79	5513+5526	747	160x90	155-160/87-89	5513+5527	759
170x80	165-170/77-79	5515+5526	753	170x90	165-170/87-89	5515+5527	765
180x80	175-180/77-79	5517+5526	765	180x90	175-180/87-89	5517+5527	777
Pletina embellecedora		0007	30				

Opción perfil unión **fijo + fijo** usando ref. 0182, aumenta rango 1,2 cm en uno de los lados. **El lateral fijo debe ser a medida.**

Se pueden combinar frontales de medidas intermedias, el rango no varía.

Las aperturas son las mismas que en los frontales.



Guiador y soporte fijo en acero



Tirador metálico



Nuevo rod. minimal blindado



Detalle unión con lateral fijo



### Laterales fijos a medida (más información en página 282)

Descripción	Referencias	Puntos	Cajonado
Lateral fijo a medida VITRO hasta 40 cm	1351	242	+21
Lateral fijo a medida VITRO de 40 hasta 80 cm	1352	320	+21
Lateral fijo a medida VITRO de 80 hasta 120 cm	1353	390	+21

\*Plazo de entrega 15 días

## VITRO frontal + fijo en línea



Descripción	Medidas	Rango	Referencias	Puntos
VITRO 100+ FIJO 20	120	113-120	5001+5534+1200+1213	560
VITRO 105+ FIJO 20	125	117-125	5002+5534+1200+1213	567
VITRO 110+ FIJO 20	130	123-130	5003+5534+1200+1213	573
VITRO 115+ FIJO 20	135	128-135	5004+5534+1200+1213	578
VITRO 120+ FIJO 20	140	133-140	5005+5534+1200+1213	582
VITRO 125+ FIJO 20	145	138-145	5006+5538+1200+1213	599
VITRO 130+ FIJO 20	150	143-150	5007+5538+1200+1213	604
VITRO 135+ FIJO 20	155	147-155	5008+5538+1200+1213	608
VITRO 140+ FIJO 20	160	152-160	5009+5538+1200+1213	614
VITRO 145+ FIJO 20	165	157-165	5010+5538+1200+1213	619
VITRO 150+ FIJO 20	170	162-170	5011+5538+1200+1213	624
VITRO 155+ FIJO 20	175	167-175	5012+5538+1200+1213	631
VITRO 160+ FIJO 20	180	172-180	5013+5538+1200+1213	636



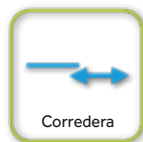
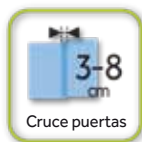

Descripción	Medidas	Rango	Referencias	Puntos
VITRO 100+ FIJO 25	125	117-125	5001+5534+1201+1213	568
VITRO 105+ FIJO 25	130	123-130	5002+5534+1201+1213	575
VITRO 110+ FIJO 25	135	128-135	5003+5534+1201+1213	581
VITRO 115+ FIJO 25	140	133-140	5004+5534+1201+1213	586
VITRO 120+ FIJO 25	145	138-145	5005+5538+1201+1213	600
VITRO 125+ FIJO 25	150	143-150	5006+5538+1201+1213	607
VITRO 130+ FIJO 25	155	147-155	5007+5538+1201+1213	612
VITRO 135+ FIJO 25	160	152-160	5008+5538+1201+1213	616
VITRO 140+ FIJO 25	165	157-165	5009+5538+1201+1213	622
VITRO 145+ FIJO 25	170	162-170	5010+5538+1201+1213	627
VITRO 150+ FIJO 25	175	167-175	5011+5538+1201+1213	632
VITRO 155+ FIJO 25	180	172-180	5012+5538+1201+1213	639
VITRO 100+ FIJO 30	130	123-130	5001+5534+1202+1213	576
VITRO 105+ FIJO 30	135	128-135	5002+5534+1202+1213	583
VITRO 110+ FIJO 30	140	133-140	5003+5534+1202+1213	589
VITRO 115+ FIJO 30	145	138-145	5004+5538+1202+1213	604
VITRO 120+ FIJO 30	150	143-150	5005+5538+1202+1213	608
VITRO 125+ FIJO 30	155	147-155	5006+5538+1202+1213	615
VITRO 130+ FIJO 30	160	152-160	5007+5538+1202+1213	620
VITRO 135+ FIJO 30	165	157-165	5008+5538+1202+1213	624
VITRO 140+ FIJO 30	170	162-170	5009+5538+1202+1213	630
VITRO 145+ FIJO 30	175	167-175	5010+5538+1202+1213	635
VITRO 150+ FIJO 30	180	172-180	5011+5538+1202+1213	640
VITRO 100+ FIJO 40	140	133-140	5001+5534+1203+1213	592
VITRO 105+ FIJO 40	145	138-145	5002+5538+1203+1213	609
VITRO 110+ FIJO 40	150	143-150	5003+5538+1203+1213	615
VITRO 115+ FIJO 40	155	147-155	5004+5538+1203+1213	620
VITRO 120+ FIJO 40	160	152-160	5005+5538+1203+1213	624
VITRO 125+ FIJO 40	165	157-165	5006+5538+1203+1213	631
VITRO 130+ FIJO 40	170	162-170	5007+5538+1203+1213	636
VITRO 135+ FIJO 40	175	167-175	5008+5538+1203+1213	640
VITRO 140+ FIJO 40	180	172-180	5009+5538+1203+1213	646
VITRO 100+ FIJO 50	150	143-150	5001+5538+1204+1213	618
VITRO 105+ FIJO 50	155	147-155	5002+5538+1204+1213	625
VITRO 110+ FIJO 50	160	152-160	5003+5538+1204+1213	631
VITRO 115+ FIJO 50	165	157-165	5004+5538+1204+1213	636
VITRO 120+ FIJO 50	170	162-170	5005+5538+1204+1213	640
VITRO 125+ FIJO 50	175	167-175	5006+5538+1204+1213	647
VITRO 130+ FIJO 50	180	172-180	5007+5538+1204+1213	652
VITRO 100+ FIJO 60	160	152-160	5001+5538+1205+1213	633
VITRO 105+ FIJO 60	165	157-165	5002+5538+1205+1213	640
VITRO 110+ FIJO 60	170	162-170	5003+5538+1205+1213	646
VITRO 115+ FIJO 60	175	167-175	5004+5538+1205+1213	651
VITRO 120+ FIJO 60	180	172-180	5005+5538+1205+1213	655

Opción perfil unión fijo + fijo usando ref. 0182, aumenta rango 1,2 cm en uno de los lados. El lateral fijo debe ser a medida.

# prestige

"Fiabilidad y prestaciones  
al mejor precio"





# PRESTIGE semicircular



Tirador metálico



Rodamiento rfzdo. doble



Pulsador liberador

Descripción	Rango	Apertura	Ref.	Puntos
80x80 RADIO ITALIANO R55	76,5-79,5	46	0011	395
90x90 RADIO ITALIANO R55	86,5-89,5	52	0013	410
80x80 RADIO ROCA R50	76,5-79,5	46	0046	395
90x90 RADIO ROCA R50	86,5-89,5	52	0047	410
Perfil de compensación +2 cm			0218	25
Perfil de compensación +4 cm			0029	35

# PRESTIGE FROST PLUS semicircular



Descripción	Rango	Apertura	Ref.	Puntos
80x80 RADIO ITALIANO R55	76,5-79,5	46	0052	420
90x90 RADIO ITALIANO R55	86,5-89,5	52	0053	435
80x80 RADIO ROCA R50	76,5-79,5	46	0048	420
90x90 RADIO ROCA R50	86,5-89,5	52	0049	435
Perfil de compensación +2 cm			0218	25
Perfil de compensación +4 cm			0029	35

## PRESTIGE 1fijo+1corredera



Descripción	Rangos	Apertura	TRANSPARENTE		FROST PLUS	
			Referencias	Puntos	Referencias	Puntos
PRESTIGE 100X195	97-103	38	0200	295	0272	320
PRESTIGE 110X195	107-113	43	0201	305	0273	335
PRESTIGE 120X195	117-123	48	0202	315	0274	350
PRESTIGE 130X195	127-133	53	0203	330	0275	365
PRESTIGE 140X195	137-143	58	0204	355	0276	380
PRESTIGE 150X195	147-153	63	0205	375	0277	400
PRESTIGE 160X195	157-163	58	0206	395	0278	425
PRESTIGE 170X195	167-173	63	0207	415	0279	450
Perfil compensación +2 cm					0218	25
Perfil compensación +4 cm					0029	35

\*Se puede combinar con el lateral fijo STD (ver pág. 64), el rango aumenta en 0,7 y se pierde la expansión en el lado dónde se instala el fijo.



# PRESTIGE SPAZIO 2fijos+2correderas



Descripción	Rangos	Apertura	TRANSPARENTE		FROST PLUS	
			Referencias	Puntos	Referencias	Puntos
PRESTIGE SPAZIO 140X195	136-142	53	0610	410	0616	435
PRESTIGE SPAZIO 150X195	146-152	58	0611	425	0617	460
PRESTIGE SPAZIO 160X195	156-162	63	0612	440	0618	470
PRESTIGE SPAZIO 170X195	166-172	68	0613	455	0619	480
PRESTIGE SPAZIO 180X195	176-182	73	0614	465	0620	490
PRESTIGE SPAZIO 190X195	186-192	78	0615	475	0621	500
Perfil compensación +2 cm					0218	25
Perfil compensación +4 cm					0029	35

\*Se puede combinar con el lateral fijo STD (ver pág. 64), el rango aumenta en 0,7 y se pierde la expansión en el lado dónde se instala el fijo.

# PRESTIGE angular al vértice



Descripción	TRANSPARENTE		FROST PLUS	
	Ref.	Puntos	Ref.	Puntos
Lado <b>70</b> x195 cm PRESTIGE	<b>0313</b>	<b>200</b>	<b>0295</b>	<b>220</b>
Lado <b>75</b> x195 cm PRESTIGE	<b>0375</b>	<b>205</b>	<b>0294</b>	<b>225</b>
Lado <b>80</b> x195 cm PRESTIGE	<b>0314</b>	<b>210</b>	<b>0296</b>	<b>230</b>
Lado <b>90</b> x195 cm PRESTIGE	<b>0315</b>	<b>220</b>	<b>0297</b>	<b>245</b>
Lado <b>100</b> x195 cm PRESTIGE	<b>0316</b>	<b>230</b>	<b>0298</b>	<b>255</b>
Lado <b>120</b> x195 cm PRESTIGE	<b>0317</b>	<b>240</b>	<b>0299</b>	<b>270</b>

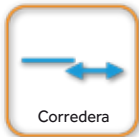

Medida	Rangos	Apert.
70x70	67-70 / 67-70	33
80x70	77-80 / 67-70	37
90x70	87-90 / 67-70	41
100x70	97-100 / 67-70	45
110x70	104-107 / 67-70	47
120x70	117-120 / 67-70	50
130x70	124-127 / 67-70	56
140x70	134-137 / 67-70	60
150x70	144-147 / 67-70	64
160x70	154-157 / 67-70	60
170x70	164-167 / 67-70	64

Medida	Rangos	Apert.
70x75	67-70 / 72-74	35
75x75	72-74 / 72-74	37
80x75	77-80 / 72-74	39
90x75	87-90 / 72-74	42
100x75	97-100 / 72-74	47
110x75	104-107 / 72-74	49
120x75	117-120 / 72-74	52
130x75	124-127 / 72-74	58
140x75	134-137 / 72-74	62
150x75	144-147 / 72-74	66
160x75	154-157 / 72-74	62
170x75	164-167 / 72-74	66

Medida	Rangos	Apert.
80x80	77-80 / 77-80	40
90x80	87-90 / 77-80	44
100x80	97-100 / 77-80	48
110x80	104-107 / 77-80	50
120x80	117-120 / 77-80	52
130x80	124-127 / 77-80	58
140x80	134-137 / 77-80	62
150x80	144-147 / 77-80	66
160x80	154-157 / 77-80	62
170x80	164-167 / 77-80	66

Medida	Rangos	Apert.
90x90	87-90 / 87-90	47
100x90	97-100 / 87-90	51
110x90	104-107 / 87-90	53
120x90	117-120 / 87-90	55
130x90	124-127 / 87-90	60
140x90	134-137 / 87-90	64
150x90	144-147 / 87-90	68
160x90	154-157 / 87-90	64
170x90	164-167 / 87-90	68

TRANSPARENTE	
Referencias	Puntos
0313 + 0313	400
0314 + 0313	410
0315 + 0313	420
0316 + 0313	430
0201 + 0313	505
0317 + 0313	440
0203 + 0313	530
0204 + 0313	555
0205 + 0313	575
0206 + 0313	595
0207 + 0313	615

Referencias	Puntos
0313 + 0375	405
0375 + 0375	410
0314 + 0375	415
0315 + 0375	425
0316 + 0375	435
0201 + 0375	510
0317 + 0375	445
0203 + 0375	535
0204 + 0375	560
0205 + 0375	580
0206 + 0375	600
0207 + 0375	620

Referencias	Puntos
0314 + 0314	420
0315 + 0314	430
0316 + 0314	440
0201 + 0314	515
0317 + 0314	450
0203 + 0314	540
0204 + 0314	565
0205 + 0314	585
0206 + 0314	605
0207 + 0314	625

Referencias	Puntos
0315 + 0315	440
0316 + 0315	450
0201 + 0315	525
0317 + 0315	460
0203 + 0315	550
0204 + 0315	575
0205 + 0315	595
0206 + 0315	615
0207 + 0315	635

FROST PLUS	
Referencias	Puntos
0295 + 0295	440
0296 + 0295	450
0297 + 0295	465
0298 + 0295	475
0273 + 0295	555
0299 + 0295	490
0275 + 0295	585
0276 + 0295	600
0277 + 0295	620
0278 + 0295	645
0279 + 0295	670

Referencias	Puntos
0295 + 0294	445
0294 + 0294	450
0296 + 0294	455
0297 + 0294	470
0298 + 0294	480
0273 + 0294	560
0299 + 0294	495
0275 + 0294	590
0276 + 0294	605
0277 + 0294	625
0278 + 0294	650
0279 + 0294	675

Referencias	Puntos
0296 + 0296	460
0297 + 0296	475
0298 + 0296	485
0273 + 0296	565
0299 + 0296	500
0275 + 0296	595
0276 + 0296	610
0277 + 0296	630
0278 + 0296	655
0279 + 0296	680

Referencias	Puntos
0297 + 0297	490
0298 + 0297	500
0273 + 0297	580
0299 + 0297	515
0275 + 0297	610
0276 + 0297	625
0277 + 0297	645
0278 + 0297	670
0279 + 0297	695

También se pueden obtener combinaciones con lados de 100 y 120

Descripción	Referencias	Puntos
Perfil compensación +2 cm	0218	25
Perfil compensación +4 cm	0029	35

## PRESTIGE frontal + lateral fijo 8 mm



Descripción	Rangos (min-max)	Referencias	Puntos
Lateral fijo STD 8 mm 30x195	26-29	0810	155
Lateral fijo STD 8 mm 40x195	36-39	0811	165
Lateral fijo STD 8 mm 50x195	46-49	0812	175
Lateral fijo STD 8 mm 60x195	56-59	0813	185
Lateral fijo STD 8 mm 70x195	66-69	0814	195
Lateral fijo STD 8 mm 75x195	71-74	0820	200
Lateral fijo STD 8 mm 80x195	76-79	0815	205
Lateral fijo STD 8 mm 90x195	86-89	0816	220
Lateral fijo STD 8 mm FROST PLUS 70	66-69	0817	230
Lateral fijo STD 8 mm FROST PLUS 80	76-79	0818	240
Lateral fijo STD 8 mm FROST PLUS 90	86-89	0819	250



H195

Altura



8/6mm

Grosor cristal

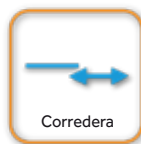

Corredera



3cm

Expansión



Magnético



Reversible



aluminio  
AL  
aluminium



Tratamiento antirreflexivo  
clear shield glass

PRESTIGE + lateral fijo de 8 mm



cierre imán oculto



rodamiento rfzdo. doble



pulsador liberador

Medidas	Rangos	Apert.	TRANSPARENTE		FROST PLUS	
			Referencias	Puntos	Referencias	Puntos
100x70	97,4-100,4 / 66-69	38	0200 + 0814	490	0272 + 0817	550
110x70	107,4-110,4 / 66-69	43	0201 + 0814	500	0273 + 0817	565
120x70	117,4-120,4 / 66-69	48	0202 + 0814	510	0274 + 0817	580
130x70	127,4-130,4 / 66-69	53	0203 + 0814	525	0275 + 0817	595
140x70	137,4-140,4 / 66-69	58	0204 + 0814	550	0276 + 0817	610
150x70	147,4-150,4 / 66-69	53	0205 + 0814	570	0277 + 0817	630
160x70	157,4-160,4 / 66-69	58	0206 + 0814	590	0278 + 0817	655
170x70	167,4-170,4 / 66-69	63	0207 + 0814	610	0279 + 0817	680
Medidas	Rangos	Apert.	Referencias	Puntos	Referencias	Puntos
100x80	97,4-100,4 / 76-79	38	0200 + 0815	500	0272 + 0818	560
110x80	107,4-110,4 / 76-79	43	0201 + 0815	510	0273 + 0818	575
120x80	117,4-120,4 / 76-79	48	0202 + 0815	520	0274 + 0818	590
130x80	127,4-130,4 / 76-79	53	0203 + 0815	535	0275 + 0818	605
140x80	137,4-140,4 / 76-79	58	0204 + 0815	560	0276 + 0818	620
150x80	147,4-150,4 / 76-79	53	0205 + 0815	580	0277 + 0818	640
160x80	157,4-160,4 / 76-79	58	0206 + 0815	600	0278 + 0818	665
170x80	167,4-170,4 / 76-79	63	0207 + 0815	630	0279 + 0818	690
Medidas	Rangos	Apert.	Referencias	Puntos	Referencias	Puntos
100x90	97,4-100,4 / 86-89	38	0200 + 0816	515	0272 + 0819	570
110x90	107,4-110,4 / 86-89	43	0201 + 0816	525	0273 + 0819	585
120x90	117,4-120,4 / 86-89	48	0202 + 0816	535	0274 + 0819	600
130x90	127,4-130,4 / 86-89	53	0203 + 0816	550	0275 + 0819	615
140x90	137,4-140,4 / 86-89	58	0204 + 0816	575	0276 + 0819	630
150x90	147,4-150,4 / 86-89	53	0205 + 0816	595	0277 + 0819	650
160x90	157,4-160,4 / 86-89	58	0206 + 0816	615	0278 + 0819	675
170x90	167,4-170,4 / 86-89	63	0207 + 0816	635	0279 + 0819	700

\*Se pueden hacer otras combinaciones con medidas intermedias de frontales

Descripción	Referencias	Puntos
Perfil compensación +2 cm	0218	25
Perfil compensación +4 cm	0029	35
Perfil compensación (+ 5,5 cm)	0219	35



Descripción	TRANSPARENTE		FROST PLUS		Cajonado
	Ref.	Puntos	Ref.	Puntos	
Lateral fijo a medida hasta 40 cm	1343	175	1343+1312	297	+21
Lateral fijo a medida de 40 hasta 80 cm	1304	250	1304+1313	372	+21
Lateral fijo a medida de 80 hasta 120 cm	1310	320	1310+1315	442	+21

\*Plazo de entrega 15 días (más información en página 282)



# aktual

"Evolución y prestaciones  
Prestige sin perfilería inferior"







# AKTUAL 1 fijo+1 corredera



Descripción	Rangos	Apertura	TRANSPARENTE		FROST PLUS	
			Referencias	Puntos	Referencias	Puntos
AKTUAL 100X195	97-103	38	0280	310	0580	350
AKTUAL 110X195	107-113	43	0281	320	0581	360
AKTUAL 120X195	117-123	48	0282	335	0582	370
AKTUAL 130X195	127-133	53	0283	360	0583	400
AKTUAL 140X195	137-143	58	0284	385	0584	425
AKTUAL 150X195	147-153	63	0285	400	0585	445
AKTUAL 160X195	157-163	58	0286	415	0586	455
AKTUAL 170X195	167-173	63	0287	435	0587	480
Perfil compensación +2 cm					0218	25
Perfil compensación +4 cm					0029	35

\*Se puede combinar con el lateral fijo STD (ver pág. 72), el rango aumenta en 0,7 y se pierde la expansión en el lado dónde se instala el fijo.

# AKTUAL SPAZIO 2fijos+2correderas

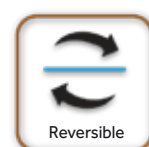
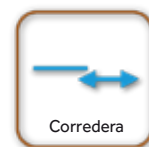

Descripción	Rangos	Apertura	TRANSPARENTE		FROST PLUS	
			Referencias	Puntos	Referencias	Puntos
AKTUAL SPAZIO 140X195	136-142	53	0570	410	0588	460
AKTUAL SPAZIO 150X195	146-152	58	0571	425	0589	485
AKTUAL SPAZIO 160X195	156-162	63	0572	440	0590	505
AKTUAL SPAZIO 170X195	166-172	68	0573	455	0591	530
AKTUAL SPAZIO 180X195	176-182	73	0574	470	0592	545
AKTUAL SPAZIO 190X195	186-192	78	0575	485	0593	565
Perfil compensación +2 cm					0218	25
Perfil compensación +4 cm					0029	35

\*Se puede combinar con el lateral fijo STD (ver pág. 72), el rango aumenta en 0,7 y se pierde la expansión en el lado dónde se instala el fijo.

# AKTUAL angular al vértice



Descripción	TRANSPARENTE		FROST PLUS	
	Ref.	Puntos	Ref.	Puntos
Lado 70x195 AKTUAL 1fijo+1corredera	0320	215	0595	245
Lado 80x195 AKTUAL 1fijo+1corredera	0321	230	0596	260
Lado 90x195 AKTUAL 1fijo+1corredera	0322	240	0597	275
Lado 100x195 AKTUAL 1fijo+1corredera	0323	250	0598	290
Lado 120x195 AKTUAL 1fijo+1corredera	0324	260	0599	310



H195

Altura



8/6mm

Grosor cristal

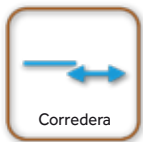

Corredera



3cm

Expansión



Magnético



Reversible



aluminio  
AL  
aluminium



Antical  
CLEAR  
SHIELD  
GLASS

combinaciones angular **AKTUAL** apertura al vértice



Tirador



Doble rodamiento  
antivuelco



Vierteaguas metálico

Medida	Rangos	Apert.
70x70	67-70 / 67-70	33
80x70	77-80 / 67-70	37
90x70	87-90 / 67-70	41
100x70	97-100 / 67-70	45
110x70	104-107 / 67-70	47
120x70	117-120 / 67-70	50
130x70	124-127 / 67-70	56
140x70	134-137 / 67-70	60
150x70	144-147 / 67-70	64

Medida	Rangos	Apert.
80x80	77-80 / 77-80	40
90x80	87-90 / 77-80	44
100x80	97-100 / 77-80	48
110x80	104-107 / 77-80	50
120x80	117-120 / 77-80	52
130x80	124-127 / 77-80	58
140x80	134-137 / 77-80	62
150x80	144-147 / 77-80	66

Medida	Rangos	Apert.
90x90	87-90 / 87-90	47
100x90	97-100 / 87-90	51
110x90	104-107 / 87-90	53
120x90	117-120 / 87-90	55
130x90	124-127 / 87-90	60
140x90	134-137 / 87-90	64
150x90	144-147 / 87-90	68

TRANSPARENTE	
Referencias	Puntos
0320 + 0320	430
0321 + 0320	445
0322 + 0320	455
0323 + 0320	465
0281 + 0320	535
0324 + 0320	475
0283 + 0320	575
0284 + 0320	600
0285 + 0320	615

Referencias	Puntos
0321 + 0321	460
0322 + 0321	470
0323 + 0321	480
0281 + 0321	550
0324 + 0321	490
0283 + 0321	590
0284 + 0321	615
0285 + 0321	630

Referencias	Puntos
0322 + 0322	480
0323 + 0322	490
0281 + 0322	560
0324 + 0322	500
0283 + 0322	575
0284 + 0322	625
0285 + 0322	640

FROST PLUS	
Referencias	Puntos
0595 + 0595	490
0596 + 0595	505
0597 + 0595	520
0598 + 0595	535
0581 + 0595	605
0599 + 0595	555
0583 + 0595	645
0584 + 0595	670
0585 + 0595	690

Referencias	Puntos
0596 + 0596	520
0597 + 0596	535
0598 + 0596	550
0581 + 0596	620
0599 + 0596	570
0583 + 0596	660
0584 + 0596	685
0585 + 0596	705

Referencias	Puntos
0597 + 0597	550
0598 + 0597	565
0581 + 0597	635
0599 + 0597	585
0583 + 0597	675
0584 + 0597	700
0585 + 0597	720

También se pueden obtener combinaciones con lados de 100 y 120

Descripción	Referencia	Puntos
Perfil compensación +2 cm	0218	25
Perfil compensación +4 cm	0029	35



## AKTUAL frontal + lateral fijo STD 8 mm



Descripción	Rangos (min-max)	Referencias	Puntos
Lateral fijo STD 8 mm 30	26-29	0810	155
Lateral fijo STD 8 mm 40	36-39	0811	165
Lateral fijo STD 8 mm 50	46-49	0812	175
Lateral fijo STD 8 mm 60	56-59	0813	185
Lateral fijo STD 8 mm 70	66-69	0814	195
Lateral fijo STD 8 mm 75	71-74	0820	200
Lateral fijo STD 8 mm 80	76-79	0815	205
Lateral fijo STD 8 mm 90	86-89	0816	220
Lateral fijo STD 8 mm FROST PLUS 70	66-69	0817	230
Lateral fijo STD 8 mm FROST PLUS 80	76-79	0818	240
Lateral fijo STD 8 mm FROST PLUS 90	86-89	0819	250





H195

Altura



8/6mm

Grosor cristal

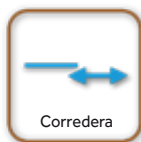

Corredera



3cm

Expansión



Magnético



Reversible



aluminio  
AL  
aluminium



tratamiento  
antical  
clear  
shield  
glass



Cierre imán oculto



Doble rodamiento antivuelco



Verteaguas metálico

AKTUAL + lateral fijo de 8 mm

Medidas	Rangos	Apert.	TRANSPARENTE		FROST PLUS	
			Referencias	Puntos	Referencias	Puntos
100x70	97,4-100,4 / 66-69	38	0280 + 0814	505	0580 + 0817	580
110x70	107,4-110,4 / 66-69	43	0281 + 0814	515	0581 + 0817	590
120x70	117,4-120,4 / 66-69	48	0282 + 0814	530	0582 + 0817	600
130x70	127,4-130,4 / 66-69	53	0283 + 0814	555	0583 + 0817	630
140x70	137,4-140,4 / 66-69	58	0284 + 0814	580	0584 + 0817	655
150x70	147,4-150,4 / 66-69	53	0285 + 0814	595	0585 + 0817	675
160x70	157,4-160,4 / 66-69	58	0286 + 0814	610	0586 + 0817	685
170x70	167,4-170,4 / 66-69	63	0287 + 0814	630	0587 + 0817	710
Medidas	Rangos	Apert.	Referencias	Puntos	Referencias	Puntos
100x80	97,4-100,4 / 76-79	38	0280 + 0815	515	0580 + 0818	590
110x80	107,4-110,4 / 76-79	43	0281 + 0815	525	0581 + 0818	600
120x80	117,4-120,4 / 76-79	48	0282 + 0815	540	0582 + 0818	610
130x80	127,4-130,4 / 76-79	53	0283 + 0815	565	0583 + 0818	640
140x80	137,4-140,4 / 76-79	58	0284 + 0815	590	0584 + 0818	665
150x80	147,4-150,4 / 76-79	53	0285 + 0815	605	0585 + 0818	685
160x80	157,4-160,4 / 76-79	58	0286 + 0815	620	0586 + 0818	695
170x80	167,4-170,4 / 76-79	63	0287 + 0815	640	0587 + 0818	720
Medidas	Rangos	Apert.	Referencias	Puntos	Referencias	Puntos
100x90	97,4-100,4 / 86-89	38	0280 + 0816	530	0580 + 0819	600
110x90	107,4-110,4 / 86-89	43	0281 + 0816	540	0581 + 0819	610
120x90	117,4-120,4 / 86-89	48	0282 + 0816	555	0582 + 0819	620
130x90	127,4-130,4 / 86-89	53	0283 + 0816	580	0583 + 0819	650
140x90	137,4-140,4 / 86-89	58	0284 + 0816	605	0584 + 0819	675
150x90	147,4-150,4 / 86-89	53	0285 + 0816	620	0585 + 0819	695
160x90	157,4-160,4 / 86-89	58	0286 + 0816	635	0586 + 0819	705
170x90	167,4-170,4 / 86-89	63	0287 + 0816	655	0587 + 0819	730

\*Se pueden hacer otras combinaciones con medidas intermedias de frontales

Descripción	Referencias	Puntos
Perfil compensación +2 cm	0218	25
Perfil compensación +4 cm	0029	35
Perfil compensación + 5,5 cm	0219	35



Descripción	TRANSPARENTE		FROST PLUS		Cajonado
	Ref.	Puntos	Ref.	Puntos	
Lateral fijo a medida hasta 40 cm	1343	175	1343+1312	297	+21
Lateral fijo a medida de 40 hasta 80 cm	1304	250	1304+1313	372	+21
Lateral fijo a medida de 80 hasta 120 cm	1310	320	1310+1315	442	+21

\*Plazo de entrega 15 días. Más información en página 282.

TWENTY GOLD pg.76



TWENTY BLACK pg.84



BASIC TITANIO pg.92



BASIC BLACK pg.92



BASIC WHITE pg.92



## MAMPARAS COLOR ALUMINIO CORREDERAS

# TWENTY GOLD 1fijo+1corredera

Oro cepillado



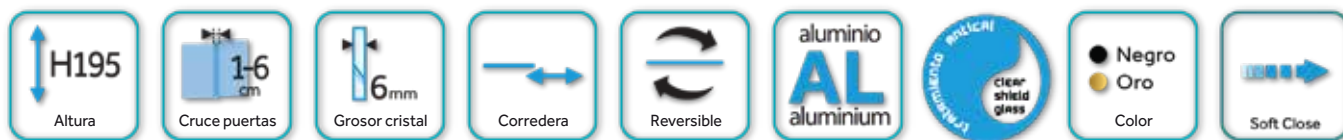

frontales TWENTY GOLD 1fijo + 1corredera

Medida	Apertura	Ref.	Puntos
115-120	46-51	2000+2044	438
120-125	49-54	2001+2044	442
125-130	51-56	2002+2044	446
130-135	54-59	2003+2044	450
135-140	56-61	2004+2044	454
140-145	59-64	2005+2044	458
145-150	61-66	2006+2044	462
150-155	64-69	2007+2045	527
155-160	66-71	2008+2045	531
160-165	69-74	2009+2045	535
165-170	71-76	2010+2045	538
170-175	74-79	2011+2045	543
175-180	76-81	2012+2045	547



Guiador desmontable



Rodamiento oculto



Doble asa metálica



Cierre/apertura soft close



Mamparas a medida y cristales especiales

TRANSPARENTE

+45%

FROST PLUS  
PARSOL / MATE

+60%

\*Plazo de entrega 15 días (más información en pág. 280)

# TWENTY SPAZIO GOLD 2 fijos+2 correderas

Oro cepillado



	TRANSPARENTE	FROST PLUS PARSOL / MATE	CAJONADO
Mamparas a medida y cristales especiales	+45%	+60%	+21

\*Plazo de entrega 15 días (más información en pág. 280)



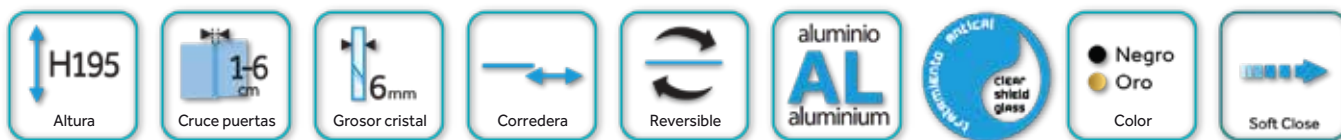

## TWENTY SPAZIO GOLD 2 fijos + 2 correderas

Descripción	Rango	Apertura	Ref.	Puntos
TWENTY SPAZIO GOLD 140	131-141	44-54	2031+2031+2047	634
TWENTY SPAZIO GOLD 150	141-151	49-59	2032+2032+2047	642
TWENTY SPAZIO GOLD 160	151-161	54-64	2033+2033+2047	652
TWENTY SPAZIO GOLD 170	161-171	59-69	2034+2034+2047	662
TWENTY SPAZIO GOLD 180	171-181	64-74	2035+2035+2047	670
TWENTY SPAZIO GOLD 190	181-191	69-79	2036+2036+2047	678

\*Admite lateral fijo en ambos lados



Innovador sistema antivuelco



Rodamiento oculto



Doble asa metálica



Apertura soft close

# TWENTY GOLD angular al vértice

Oro cepillado



	TRANSPARENTE	FROST PLUS PARSOL / MATE	CAJONADO
Mamparas a medida y cristales especiales	+45%	+60%	+21

\*Plazo de entrega 15 días (más información en pág. 280)

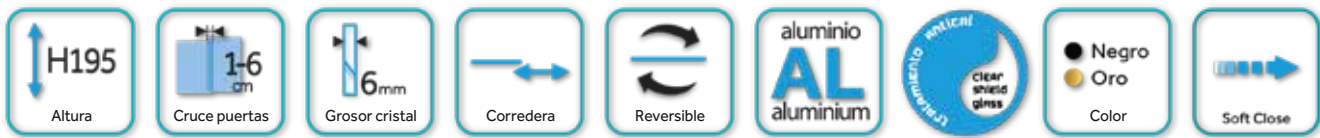

combinaciones **TWENTY GOLD** al vértice

Medida	Rangos	Apertura	Referencias	Puntos
70X70	65-70/65-70	30-35	2030+2030+2046	637
75X70	70-75/65-70	32-37	2031+2030+2046	642
80X70	75-80/65-70	34-39	2032+2030+2046	646
85X70	80-85/65-70	36-41	2033+2030+2046	651
90X70	85-90/65-70	38-43	2034+2030+2046	656
95X70	90-95/65-70	40-45	2035+2030+2046	660
100X70	95-100/65-70	42-47	2036+2030+2046	664
120X70	115-120/65-70	52-57	2037+2030+2046	683
Medida	Rangos	Apertura	Referencias	Puntos
75X75	70-75/70-75	34-39	2031+2031+2046	647
80X75	75-80/70-75	36-41	2032+2031+2046	651
85X75	80-85/70-75	38-43	2033+2031+2046	656
90X75	85-90/70-75	40-45	2034+2031+2046	661
95X75	90-95/70-75	42-47	2035+2031+2046	665
100X75	95-100/70-75	45-50	2036+2031+2046	669
120X75	115-120/70-75	54-59	2037+2031+2046	688
Medida	Rangos	Apertura	Referencias	Puntos
80X80	75-80/75-80	38-43	2032+2032+2046	655
85X80	80-85/75-80	40-45	2033+2032+2046	660
90X80	85-90/75-80	42-47	2034+2032+2046	665
95X80	90-95/75-80	45-50	2035+2032+2046	669
100X80	95-100/75-80	47-52	2036+2032+2046	673
120X80	115-120/75-80	56-61	2037+2032+2046	692
Medida	Rangos	Apertura	Referencias	Puntos
90X90	85-90/85-90	47-52	2034+2034+2046	675
95X90	90-95/85-90	49-54	2035+2034+2046	679
100X90	95-100/85-90	50-55	2036+2034+2046	683
120X90	115-120/85-90	60-65	2037+2034+2046	702

Las aperturas son las mismas que en los frontales

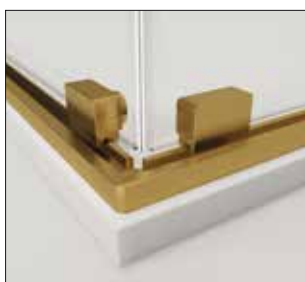

Innovador sistema antivuelco



Rodamiento oculto



Doble asa metálica



Apertura soft close

# TWENTY GOLD frontal + lat. fijo

Oro cepillado



Descripción	Rango	Ref.	Puntos
Lateral fijo TWENTY GOLD 70	66,5-69,5	2048	210
Lateral fijo TWENTY GOLD 75	71,5-74,5	2049	219
Lateral fijo TWENTY GOLD 80	76,5-79,5	2050	228
Lateral fijo TWENTY GOLD 90	86,5-89,5	2051	246



## Laterales fijos a medida (más información en página 282)

Descripción	Referencias	Puntos	Cajonado
Lateral fijo a medida TWENTY hasta 40 cm	1375OR	237	+21
Lateral fijo a medida TWENTY de 40 hasta 80 cm	1376OR	316	+21
Lateral fijo a medida TWENTY de 80 hasta 120 cm	1377OR	388	+21

\*Plazo de entrega 15 días

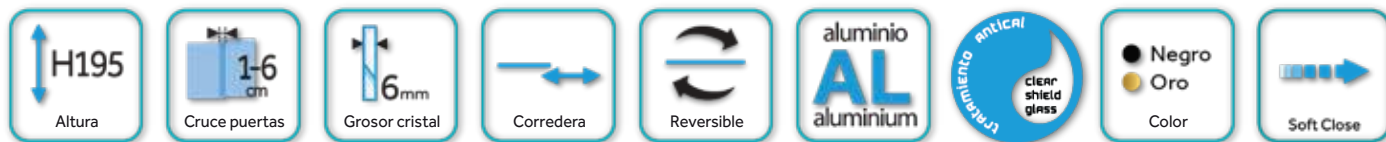

combinaciones frontales **TWENTY GOLD** + lateral fijo de 6 mm

Medida	Rangos	Referencias	Puntos	Medida	Rangos	Referencias	Puntos
120X70	115-120/66,5-69,5	2000+2044+2048	648	120X75	115-120/71,5-74,5	2000+2044+2049	657
125X70	120-125/66,5-69,5	2001+2044+2048	652	125X75	120-125/71,5-74,5	2001+2044+2049	661
130X70	125-130/66,5-69,5	2002+2044+2048	656	130X75	125-130/71,5-74,5	2002+2044+2049	665
135X70	130-135/66,5-69,5	2003+2044+2048	660	135X75	130-135/71,5-74,5	2003+2044+2049	669
140X70	135-140/66,5-69,5	2004+2044+2048	664	140X75	135-140/71,5-74,5	2004+2044+2049	673
145X70	140-145/66,5-69,5	2005+2044+2048	668	145X75	140-145/71,5-74,5	2005+2044+2049	677
150X70	145-150/66,5-69,5	2006+2044+2048	672	150X75	145-150/71,5-74,5	2006+2044+2049	681
155X70	150-155/66,5-69,5	2007+2045+2048	737	155X75	150-155/71,5-74,5	2007+2045+2049	746
160X70	155-160/66,5-69,5	2008+2045+2048	741	160X75	155-160/71,5-74,5	2008+2045+2049	750
165X70	160-165/66,5-69,5	2009+2045+2048	745	165X75	160-165/71,5-74,5	2009+2045+2049	754
170X70	165-170/66,5-69,5	2010+2045+2048	748	170X75	165-170/71,5-74,5	2010+2045+2049	757
175X70	170-175/66,5-69,5	2011+2045+2048	753	175X75	170-175/71,5-74,5	2011+2045+2049	762
180X70	175-180/66,5-69,5	2012+2045+2048	757	180X75	175-180/71,5-74,5	2012+2045+2049	766
Medida	Rangos	Referencias	Puntos	Medida	Rangos	Referencias	Puntos
120X80	115-120/76,5-79,5	2000+2044+2050	666	120X90	115-120/86,5-89,5	2000+2044+2051	684
125X80	120-125/76,5-79,5	2001+2044+2050	670	125X90	120-125/86,5-89,5	2001+2044+2051	688
130X80	125-130/76,5-79,5	2002+2044+2050	674	130X90	125-130/86,5-89,5	2002+2044+2051	692
135X80	130-135/76,5-79,5	2003+2044+2050	678	135X90	130-135/86,5-89,5	2003+2044+2051	696
140X80	135-140/76,5-79,5	2004+2044+2050	682	140X90	135-140/86,5-89,5	2004+2044+2051	700
145X80	140-145/76,5-79,5	2005+2044+2050	686	145X90	140-145/86,5-89,5	2005+2044+2051	704
150X80	145-150/76,5-79,5	2006+2044+2050	690	150X90	145-150/86,5-89,5	2006+2044+2051	708
155X80	150-155/76,5-79,5	2007+2045+2050	755	155X90	150-155/86,5-89,5	2007+2045+2051	773
160X80	155-160/76,5-79,5	2008+2045+2050	759	160X90	155-160/86,5-89,5	2008+2045+2051	777
165X80	160-165/76,5-79,5	2009+2045+2050	763	165X90	160-165/86,5-89,5	2009+2045+2051	781
170X80	165-170/76,5-79,5	2010+2045+2050	766	170X90	165-170/86,5-89,5	2010+2045+2051	784
175X80	170-175/76,5-79,5	2011+2045+2050	771	175X90	170-175/86,5-89,5	2011+2045+2051	789
180X80	175-180/76,5-79,5	2012+2045+2050	775	180X90	175-180/86,5-89,5	2012+2045+2051	793

Las aperturas son las mismas que en los frontales



Guiador desmontable



Rodamiento oculto



Doble asa metálica



Cierre/apertura soft close

TWENTY BLACK 1fijo+1corredera





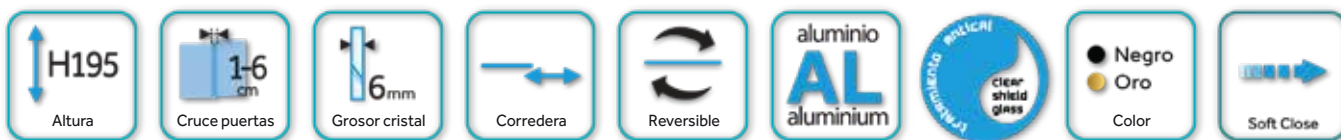

frontales **TWENTY BLACK** 1fijo + 1corredera

Medida	Apertura	Ref.	Puntos
115-120	46-51	2000+2023	408
120-125	49-54	2001+2023	412
125-130	51-56	2002+2023	416
130-135	54-59	2003+2023	420
135-140	56-61	2004+2023	424
140-145	59-64	2005+2023	428
145-150	61-66	2006+2023	432
150-155	64-69	2007+2024	485
155-160	66-71	2008+2024	489
160-165	69-74	2009+2024	493
165-170	71-76	2010+2024	496
170-175	74-79	2011+2024	501
175-180	76-81	2012+2024	505



Guiador desmontable



Rodamiento oculto



Doble asa metálica



Cierre/apertura soft close



	TRANSPARENTE	FROST PLUS PARSOL / MATE
Mamparas a medida y cristales especiales	+45%	+60%

\*Plazo de entrega 15 días (más información en pág. 280)

# TWENTY SPAZIO BLACK 2 fijos+2 correderas



	TRANSPARENTE	FROST PLUS PARSOL / MATE	CAJONADO
Mamparas a medida y cristales especiales	+45%	+60%	+21

\*Plazo de entrega 15 días (más información en pág. 280)

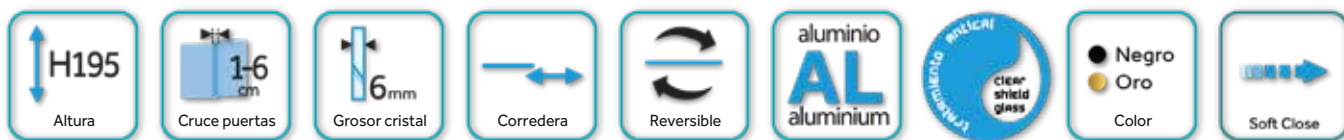

## TWENTY SPAZIO BLACK 2fijos + 2correderas

Descripción	Rango	Apertura	Ref.	Puntos
TWENTY SPAZIO BLACK 140	131-141	44-54	2031+2031+2043	602
TWENTY SPAZIO BLACK 150	141-151	49-59	2032+2032+2043	610
TWENTY SPAZIO BLACK 160	151-161	54-64	2033+2033+2043	620
TWENTY SPAZIO BLACK 170	161-171	59-69	2034+2034+2043	630
TWENTY SPAZIO BLACK 180	171-181	64-74	2035+2035+2043	638
TWENTY SPAZIO BLACK 190	181-191	69-79	2036+2036+2043	646

\*Admite lateral fijo en ambos lados



Innovador sistema antivuelco



Rodamiento oculto



Doble asa metálica



Apertura soft close

## TWENTY BLACK angular al vértice



Mamparas a medida y cristales especiales

TRANSPARENTE

+45%

FROST PLUS  
PARSOL / MATE

+60%

CAJONADO

+21

\*Plazo de entrega 15 días (más información en pág. 280)

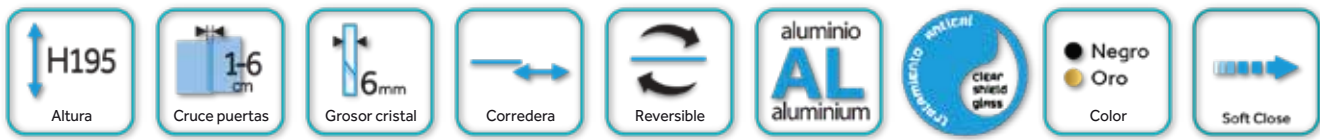

combinaciones **TWENTY BLACK** al vértice

Medida	Rangos	Apertura	Referencias	Puntos
70X70	65-70/65-70	30-35	2030+2030+2039	601
75X70	70-75/65-70	32-37	2031+2030+2039	606
80X70	75-80/65-70	34-39	2032+2030+2039	610
85X70	80-85/65-70	36-41	2033+2030+2039	615
90X70	85-90/65-70	38-43	2034+2030+2039	620
95X70	90-95/65-70	40-45	2035+2030+2039	624
100X70	95-100/65-70	42-47	2036+2030+2039	628
120X70	115-120/65-70	52-57	2037+2030+2039	647
Medida	Rangos	Apertura	Referencias	Puntos
75X75	70-75/70-75	34-39	2031+2031+2039	611
80X75	75-80/70-75	36-41	2032+2031+2039	615
85X75	80-85/70-75	38-43	2033+2031+2039	620
90X75	85-90/70-75	40-45	2034+2031+2039	625
95X75	90-95/70-75	42-47	2035+2031+2039	629
100X75	95-100/70-75	45-50	2036+2031+2039	633
120X75	115-120/70-75	54-59	2037+2031+2039	652
Medida	Rangos	Apertura	Referencias	Puntos
80X80	75-80/75-80	38-43	2032+2032+2039	619
85X80	80-85/75-80	40-45	2033+2032+2039	624
90X80	85-90/75-80	42-47	2034+2032+2039	629
95X80	90-95/75-80	45-50	2035+2032+2039	633
100X80	95-100/75-80	47-52	2036+2032+2039	637
120X80	115-120/75-80	56-61	2037+2032+2039	656
Medida	Rangos	Apertura	Referencias	Puntos
90X90	85-90/85-90	47-52	2034+2034+2039	639
95X90	90-95/85-90	49-54	2035+2034+2039	643
100X90	95-100/85-90	50-55	2036+2034+2039	647
120X90	115-120/85-90	60-65	2037+2034+2039	666

Las aperturas son las mismas que en los frontales



Innovador sistema antivuelco



Rodamiento oculto



Doble asa metálica



Apertura soft close

## TWENTY BLACK frontal + lat. fijo



Descripción	Rango	Ref.	Puntos
Lateral fijo TWENTY BLACK 70	66,5-69,5	2017	187
Lateral fijo TWENTY BLACK 75	71,5-74,5	2018	198
Lateral fijo TWENTY BLACK 80	76,5-79,5	2019	208
Lateral fijo TWENTY BLACK 90	86,5-89,5	2020	224



### Laterales fijos a medida (más información en página 282)

Descripción	Referencias	Puntos	Cajonado
Lateral fijo a medida TWENTY hasta 40 cm	1375N	217	+21
Lateral fijo a medida TWENTY de 40 hasta 80 cm	1376N	296	+21
Lateral fijo a medida TWENTY de 80 hasta 120 cm	1377N	366	+21

\*Plazo de entrega 15 días



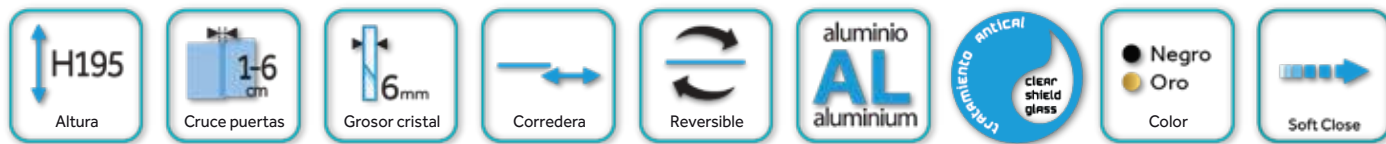

combinaciones frontales **TWENTY BLACK** + lateral fijo de 6 mm

Medida	Rangos	Referencias	Puntos	Medida	Rangos	Referencias	Puntos
120X70	115-120/66,5-69,5	2000+2023+2017	595	120X75	115-120/71,5-74,5	2000+2023+2018	606
125X70	120-125/66,5-69,5	2001+2023+2017	599	125X75	120-125/71,5-74,5	2001+2023+2018	610
130X70	125-130/66,5-69,5	2002+2023+2017	603	130X75	125-130/71,5-74,5	2002+2023+2018	614
135X70	130-135/66,5-69,5	2003+2023+2017	607	135X75	130-135/71,5-74,5	2003+2023+2018	618
140X70	135-140/66,5-69,5	2004+2023+2017	611	140X75	135-140/71,5-74,5	2004+2023+2018	622
145X70	140-145/66,5-69,5	2005+2023+2017	615	145X75	140-145/71,5-74,5	2005+2023+2018	626
150X70	145-150/66,5-69,5	2006+2023+2017	619	150X75	145-150/71,5-74,5	2006+2023+2018	630
155X70	150-155/66,5-69,5	2007+2024+2017	672	155X75	150-155/71,5-74,5	2007+2024+2018	683
160X70	155-160/66,5-69,5	2008+2024+2017	676	160X75	155-160/71,5-74,5	2008+2024+2018	687
165X70	160-165/66,5-69,5	2009+2024+2017	680	165X75	160-165/71,5-74,5	2009+2024+2018	691
170X70	165-170/66,5-69,5	2010+2024+2017	683	170X75	165-170/71,5-74,5	2010+2024+2018	694
175X70	170-175/66,5-69,5	2011+2024+2017	688	175X75	170-175/71,5-74,5	2011+2024+2018	699
180X70	175-180/66,5-69,5	2012+2024+2017	692	180X75	175-180/71,5-74,5	2012+2024+2018	703
Medida	Rangos	Referencias	Puntos	Medida	Rangos	Referencias	Puntos
120X80	115-120/76,5-79,5	2000+2023+2019	616	120X90	115-120/86,5-89,5	2000+2023+2020	632
125X80	120-125/76,5-79,5	2001+2023+2019	620	125X90	120-125/86,5-89,5	2001+2023+2020	636
130X80	125-130/76,5-79,5	2002+2023+2019	624	130X90	125-130/86,5-89,5	2002+2023+2020	640
135X80	130-135/76,5-79,5	2003+2023+2019	628	135X90	130-135/86,5-89,5	2003+2023+2020	644
140X80	135-140/76,5-79,5	2004+2023+2019	632	140X90	135-140/86,5-89,5	2004+2023+2020	648
145X80	140-145/76,5-79,5	2005+2023+2019	636	145X90	140-145/86,5-89,5	2005+2023+2020	652
150X80	145-150/76,5-79,5	2006+2023+2019	640	150X90	145-150/86,5-89,5	2006+2023+2020	656
155X80	150-155/76,5-79,5	2007+2024+2019	693	155X90	150-155/86,5-89,5	2007+2024+2020	709
160X80	155-160/76,5-79,5	2008+2024+2019	697	160X90	155-160/86,5-89,5	2008+2024+2020	713
165X80	160-165/76,5-79,5	2009+2024+2019	701	165X90	160-165/86,5-89,5	2009+2024+2020	717
170X80	165-170/76,5-79,5	2010+2024+2019	704	170X90	165-170/86,5-89,5	2010+2024+2020	720
175X80	170-175/76,5-79,5	2011+2024+2019	709	175X90	170-175/86,5-89,5	2011+2024+2020	725
180X80	175-180/76,5-79,5	2012+2024+2019	713	180X90	175-180/86,5-89,5	2012+2024+2020	729

Las aperturas son las mismas que en los frontales



Guiador desmontable



Rodamiento oculto

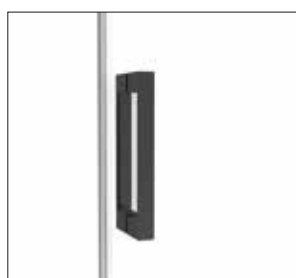

Doble asa metálica



Cierre/apertura soft close

# BASIC COLOR

## FRONTAL PERFILERÍA NEGRA



Perfilería con stopper antivuelco



Doble rodamiento regulable en nylon con antivuelco



Nuevo guizador optimizado con pulsador liberador de hoja



Opción pletina embellecedora

## FRONTAL PERFILERÍA BLANCA



## FRONTAL PERFILERÍA TITANIO



Opción tirador extraplano negro 22x1,6x0,7 cm

Ref.	Puntos
9031	25



Rango	Apert.	TRANSPARENTE			FROST PLUS		
		NEGRO	BLANCO	Puntos	NEGRO	BLANCO	Puntos
95-100	36-41	5001+5493	5001+5583	341	6001+5493	6001+5583	368
100-105	36-41	5002+5493	5002+5583	348	6002+5493	6002+5583	375
105-110	41-46	5003+5493	5003+5583	354	6003+5493	6003+5583	381
110-115	41-46	5004+5493	5004+5583	359	6004+5493	6004+5583	388
115-120	46-51	5005+5493	5005+5583	363	6005+5493	6005+5583	395
120-125	46-51	5006+5493	5006+5583	370	6006+5493	6006+5583	402
125-130	51-56	5007+5493	5007+5583	375	6007+5493	6007+5583	409
130-135	51-56	5008+5493	5008+5583	379	6008+5493	6008+5583	414
135-140	56-61	5009+5493	5009+5583	385	6009+5493	6009+5583	421
140-145	56-61	5010+5494	5010+5584	398	6010+5494	6010+5584	436
145-150	61-66	5011+5494	5011+5584	403	6011+5494	6011+5584	443
150-155	61-66	5012+5494	5012+5584	410	6012+5494	6012+5584	450
155-160	61-66	5013+5494	5013+5584	415	6013+5494	6013+5584	457
160-165	61-66	5014+5494	5014+5584	419	6014+5494	6014+5584	461
165-170	66-71	5015L+5494	5015L+5584	421	6015L+5494	6015L+5584	480
170-175	66-71	5016L+5494	5016L+5584	427	6016L+5494	6016L+5584	488
175-180	66-71	5017L+5494	5017L+5584	433	6017L+5494	6017L+5584	495
180-190	66-71	5023L+5495	5023L+5585	460	6023L+5495	6023L+5585	527
190-200	66-71	5024L+5495	5024L+5585	471	6024L+5495	6024L+5585	542

Desglose por referencias/punto en página 293.

### Opción perfilaría +20 puntos

Descripción	TITANIO	
	Ref.	Puntos
Accesorios frontal hasta 140 cm	5560	216
Accesorios de 140 cm hasta 180 cm	5561	224
Accesorios de 180 cm hasta 200 cm	5562	241

Sustituir referencia negro/blanca por referencia titanio.

### Accesorios

Descripción	NEGRO		BLANCO		TITANIO	
	Ref.	Puntos	Ref.	Puntos	Ref.	Puntos
Perfil de compensación +1,5 cm	5477	25	5473	25	5478	35
Pletina embellecedora 195x3,8 cm	0007N	30	0007B	30	0007T	40



	TRANSPARENTE	FROST PLUS PARSOL / MATE	CAJONADO
Mamparas a medida y cristales especiales	+45%	+60%	+21

\*Plazo de entrega 15 días (más información en pág. 280)

# BASIC SPAZIO COLOR

## PERFILERÍA TITANIO



Perfilería con stopper antivuelco



Doble rodamiento regulable en nylon con antivuelco



Nuevo guiador optimizado con pulsador liberador de hoja

## FRONTAL PERFILERÍA BLANCA



## FRONTAL PERFILERÍA NEGRA



Opción tirador extraplano negro 22x1,6x0,7 cm

Ref.	Puntos
9031	25



Rango	Apert.	TRANSPARENTE			FROST PLUS		
		NEGRO	BLANCO	Puntos	NEGRO	BLANCO	Puntos
132-142	46-56	5029+5029+5496	5029+5029+5586	499	6029+6029+5496	6029+6029+5586	543
142-152	56-66	5019+5019+5496	5019+5019+5586	509	6019+6019+5496	6019+6019+5586	551
152-162	54-64	5030+5030+5496	5030+5030+5586	521	6030+6030+5496	6030+6030+5586	563
162-172	66-76	5020+5020+5496	5020+5020+5586	531	6020+6020+5496	6020+6020+5586	573
172-182	62-72	5031+5031+5497	5031+5031+5587	541	6031+6031+5497	6031+6031+5587	587
182-192	76-86	5021+5021+5497	5021+5021+5587	545	6021+6021+5497	6021+6021+5587	599
190-200	76-86	5001+5001+5497	5001+5001+5587	551	6001+6001+5497	6001+6001+5587	605
200-210	76-86	5002+5002+5497	5002+5002+5587	565	6002+6002+5497	6002+6002+5587	619

Desglose por referencias/punto en página 293.

### Opción perfilaría +20 puntos

Descripción	TITANIO	
	Ref.	Puntos
Accesorios frontal hasta 172 cm	5565	277
Accesorios de 172 cm hasta 210 cm	5566	281

Sustituir referencia negro/blanca por referencia titanio.

### Accesorios

Descripción	NEGRO		BLANCO		TITANIO	
	Ref.	Puntos	Ref.	Puntos	Ref.	Puntos
Perfil de compensación +1,5 cm	5477	25	5473	25	5478	35
Pletina embellecedora 195x3,8 cm	0007N	30	0007B	30	0007T	40
Opción perfil unión fijo-fijo (indicar mano)	0991	40	0182B	40		



	TRANSPARENTE	FROST PLUS PARSOL / MATE	CAJONADO
Mamparas a medida y cristales especiales	+45%	+60%	+21

\*Plazo de entrega 15 días (más información en pág. 280)

# BASIC COLOR al vértice

## PERFILERÍA NEGRA



Perfilería con stopper antivuelco



Doble rodamiento regulable en nylon con antivuelco



Nuevo guiador optimizado con pulsador liberador de hoja

## FRONTAL PERFILERÍA BLANCA



## FRONTAL PERFILERÍA TITANIO



Opción tirador extraplano negro 22x1,6x0,7 cm

Ref.	Puntos
9031	25



Rango	TRANSPARENTE			FROST PLUS		
	NEGRO	BLANCO	Puntos	NEGRO	BLANCO	Puntos
combinaciones c/ LADOS 70 fijo+corredera						
65-70/65-70	<b>5018+5018+5490</b>	5018+5018+5580	<b>497</b>	<b>6018+6018+5490</b>	6018+6018+5580	<b>539</b>
70-75/65-70	<b>5029+5018+5490</b>	5029+5018+5580	<b>502</b>	<b>6029+6018+5490</b>	6029+6018+5580	<b>545</b>
75-80/65-70	<b>5019+5018+5490</b>	5019+5018+5580	<b>507</b>	<b>6019+6018+5490</b>	6019+6018+5580	<b>549</b>
80-85/65-70	<b>5030+5018+5490</b>	5030+5018+5580	<b>513</b>	<b>6030+6018+5490</b>	6030+6018+5580	<b>555</b>
85-90/65-70	<b>5020+5018+5490</b>	5020+5018+5580	<b>518</b>	<b>6020+6018+5490</b>	6020+6018+5580	<b>560</b>
90-95/65-70	<b>5031+5018+5490</b>	5031+5018+5580	<b>521</b>	<b>6031+6018+5490</b>	6031+6018+5580	<b>565</b>
95-100/65-70	<b>5021+5018+5490</b>	5021+5018+5580	<b>523</b>	<b>6021+6018+5490</b>	6021+6018+5580	<b>571</b>
105-109/65-70	<b>5002+5018+5490</b>	5002+5018+5580	<b>533</b>	<b>6002+6018+5490</b>	6002+6018+5580	<b>581</b>
115-120/65-70	<b>5022+5018+5490</b>	5022+5018+5580	<b>544</b>	<b>6022+6018+5490</b>	6022+6018+5580	<b>602</b>
125-129/65-70	<b>5006+5018+5491</b>	5006+5018+5581	<b>565</b>	<b>6006+6018+5491</b>	6006+6018+5581	<b>618</b>
135-139/65-70	<b>5008+5018+5491</b>	5008+5018+5581	<b>574</b>	<b>6008+6018+5491</b>	6008+6018+5581	<b>630</b>
combinaciones c/ LADOS 75 fijo+corredera						
70-75/70-75	<b>5029+5029+5490</b>	5029+5029+5580	<b>507</b>	<b>6029+6029+5490</b>	6029+6029+5580	<b>551</b>
75-80/70-75	<b>5019+5029+5490</b>	5019+5029+5580	<b>512</b>	<b>6019+6029+5490</b>	6019+6029+5580	<b>555</b>
80-85/70-75	<b>5030+5029+5490</b>	5030+5029+5580	<b>518</b>	<b>6030+6029+5490</b>	6030+6029+5580	<b>561</b>
85-90/70-75	<b>5020+5029+5490</b>	5020+5029+5580	<b>523</b>	<b>6020+6029+5490</b>	6020+6029+5580	<b>566</b>
90-95/70-75	<b>5031+5029+5490</b>	5031+5029+5580	<b>526</b>	<b>6031+6029+5490</b>	6031+6029+5580	<b>571</b>
95-100/70-75	<b>5021+5029+5490</b>	5021+5029+5580	<b>528</b>	<b>6021+6029+5490</b>	6021+6029+5580	<b>577</b>
105-109/70-75	<b>5002+5029+5490</b>	5002+5029+5580	<b>538</b>	<b>6002+6029+5490</b>	6002+6029+5580	<b>587</b>
115-120/70-75	<b>5022+5029+5490</b>	5022+5029+5580	<b>549</b>	<b>6022+6029+5490</b>	6022+6029+5580	<b>608</b>
125-129/70-75	<b>5006+5029+5491</b>	5006+5029+5581	<b>570</b>	<b>6006+6029+5491</b>	6006+6029+5581	<b>624</b>
135-139/70-75	<b>5008+5029+5491</b>	5008+5029+5581	<b>579</b>	<b>6008+6029+5491</b>	6008+6029+5581	<b>636</b>
combinaciones c/ LADOS 80 fijo+corredera						
75-80/75-80	<b>5019+5019+5490</b>	5019+5019+5580	<b>517</b>	<b>6019+6019+5490</b>	6019+6019+5580	<b>559</b>
80-85/75-80	<b>5030+5019+5490</b>	5030+5019+5580	<b>523</b>	<b>6030+6019+5490</b>	6030+6019+5580	<b>565</b>
85-90/75-80	<b>5020+5019+5490</b>	5020+5019+5580	<b>528</b>	<b>6020+6019+5490</b>	6020+6019+5580	<b>570</b>
90-95/75-80	<b>5031+5019+5490</b>	5031+5019+5580	<b>531</b>	<b>6031+6019+5490</b>	6031+6019+5580	<b>575</b>
95-100/75-80	<b>5021+5019+5490</b>	5021+5019+5580	<b>533</b>	<b>6021+6019+5490</b>	6021+6019+5580	<b>581</b>
105-109/75-80	<b>5002+5019+5490</b>	5002+5019+5580	<b>543</b>	<b>6002+6019+5490</b>	6002+6019+5580	<b>591</b>
115-120/75-80	<b>5022+5019+5490</b>	5022+5019+5580	<b>554</b>	<b>6022+6019+5490</b>	6022+6019+5580	<b>612</b>
125-129/75-80	<b>5006+5019+5491</b>	5006+5019+5581	<b>575</b>	<b>6006+6019+5491</b>	6006+6019+5581	<b>628</b>
135-139/75-80	<b>5008+5019+5491</b>	5008+5019+5581	<b>584</b>	<b>6008+6019+5491</b>	6008+6019+5581	<b>640</b>
combinaciones c/ LADOS 90 fijo+corredera						
85-90/85-90	<b>5020+5020+5490</b>	5020+5020+5580	<b>539</b>	<b>6020+6020+5490</b>	6020+6020+5580	<b>581</b>
90-95/85-90	<b>5031+5020+5490</b>	5031+5020+5580	<b>542</b>	<b>6031+6020+5490</b>	6031+6020+5580	<b>586</b>
95-100/85-90	<b>5021+5020+5490</b>	5021+5020+5580	<b>544</b>	<b>6021+6020+5490</b>	6021+6020+5580	<b>592</b>
105-109/85-90	<b>5002+5020+5490</b>	5002+5020+5580	<b>554</b>	<b>6002+6020+5490</b>	6002+6020+5580	<b>602</b>
115-120/85-90	<b>5022+5020+5490</b>	5022+5020+5580	<b>565</b>	<b>6022+6020+5490</b>	6022+6020+5580	<b>623</b>
125-129/85-90	<b>5006+5020+5491</b>	5006+5020+5581	<b>586</b>	<b>6006+6020+5491</b>	6006+6020+5581	<b>639</b>
135-139/85-90	<b>5008+5020+5491</b>	5008+5020+5581	<b>595</b>	<b>6008+6020+5491</b>	6008+6020+5581	<b>651</b>

Desglose por referencias/punto en página 293. Aperturas ver página 29.

### Opción perfilera + 20 puntos

Descripción	TITANIO	
	Ref.	Puntos
Accesorios hasta 120x90 cm	<b>5563</b>	<b>285</b>
Accesorios hasta 140x100 cm	<b>5564</b>	<b>295</b>

Sustituir referencia negro/blanca por referencia titanio.

# BASIC COLOR con lateral fijo

PERFILERÍA NEGRA



FRONTAL PERFILERÍA BLANCA



FRONTAL PERFILERÍA TITANIO



Frontales y lat. fijos a medida (ver págs. 280 y 282)

**PASO 1: Seleccionar medida/color de la PERFILERÍA**

**PASO 2: Seleccionar medida/decorado de los FRONTALES+LAT.FIJO**



## PASO 1: PERFILERÍA

Descripción

Accesorios hasta 140 cm

Accesorios hasta 180 cm

### NEGRO

Ref.	Puntos
5493+5492	281
5494+5492	289

### BLANCO

Ref.	Puntos
5583+5588	281
5584+5588	289

### TITANIO

Ref.	Puntos
5560+5567	321
5561+5567	329



## PASO 2: FRONTALES+LAT. FIJO

		TRANSPARENTE		FROST PLUS	
Medida	Rangos (cm)	Ref.	Puntos	Ref.	Puntos
<b>combinaciones c/ LATERAL FIJO DE 70</b>					
100x70	Cristales de 95-100/67-69	5001+5025	328	6001+6025	377
110x70	Cristales de 105-110/67-69	5003+5025	341	6003+6025	390
120x70	Cristales de 115-120/67-69	5005+5025	350	6005+6025	404
130x70	Cristales de 125-130/67-69	5007+5025	362	6007+6025	418
140x70	Cristales de 135-140/67-69	5009+5025	372	6009+6025	430
150x70	Cristales de 145-150/67-69	5011+5025	382	6011+6025	444
160x70	Cristales de 155-160/67-69	5013+5025	394	6013+6025	458
170x70	Cristales de 165-170/67-69	5015L+5025	400	6015L+6025	481
180x70	Cristales de 175-180/67-69	5017L+5025	412	6017L+6025	496
<b>combinaciones c/ LATERAL FIJO DE 75</b>					
100x75	Cristales de 95-100/72-74	5001+5057	332	6001+6057	387
110x75	Cristales de 105-110/72-74	5003+5057	345	6003+6057	400
120x75	Cristales de 115-120/72-74	5005+5057	354	6005+6057	414
130x75	Cristales de 125-130/72-74	5007+5057	366	6007+6057	428
140x75	Cristales de 135-140/72-74	5009+5057	376	6009+6057	440
150x75	Cristales de 145-150/72-74	5011+5057	386	6011+6057	454
160x75	Cristales de 155-160/72-74	5013+5057	398	6013+6057	468
170x75	Cristales de 165-170/72-74	5015L+5057	404	6015L+6057	491
180x75	Cristales de 175-180/72-74	5017L+5057	416	6017L+6057	506
<b>combinaciones c/ LATERAL FIJO DE 80</b>					
100x80	Cristales de 95-100/77-79	5001+5026	339	6001+6026	394
110x80	Cristales de 105-110/77-79	5003+5026	352	6003+6026	407
120x80	Cristales de 115-120/77-79	5005+5026	361	6005+6026	421
130x80	Cristales de 125-130/77-79	5007+5026	373	6007+6026	435
140x80	Cristales de 135-140/77-79	5009+5026	383	6009+6026	447
150x80	Cristales de 145-150/77-79	5011+5026	393	6011+6026	461
160x80	Cristales de 155-160/77-79	5013+5026	405	6013+6026	475
170x80	Cristales de 165-170/77-79	5015L+5026	411	6015L+6026	498
180x80	Cristales de 175-180/77-79	5017L+5026	423	6017L+6026	513
<b>combinaciones c/ LATERAL FIJO DE 90</b>					
100x90	Cristales de 95-100/87-89	5001+5027	351	6001+6027	406
110x90	Cristales de 105-110/87-89	5003+5027	364	6003+6027	419
120x90	Cristales de 115-120/87-89	5005+5027	373	6005+6027	433
130x90	Cristales de 125-130/87-89	5007+5027	385	6007+6027	447
140x90	Cristales de 135-140/87-89	5009+5027	395	6009+6027	459
150x90	Cristales de 145-150/87-89	5011+5027	405	6011+6027	473
160x90	Cristales de 155-160/87-89	5013+5027	417	6013+6027	487
170x90	Cristales de 165-170/87-89	5015L+5027	423	6015L+6027	510
180x90	Cristales de 175-180/87-89	5017L+5027	435	6017L+6027	525

\*Opción perfil unión fijo-fijo NEGRO ref. 0991 +40 puntos (indicar mano).

\*Opción perfil unión fijo-fijo BLANCO ref. 0182B +40 puntos (indicar mano).

# BASIC FIJO + PUERTA + FIJO

## PERFILERÍA NEGRA



Perfilería con stopper antivuelco



Doble rodamiento regulable en nylon con antivuelco



Nuevo guiador optimizado con pulsador liberador de hoja



Frontales a medida (ver pág. 280)

## PERFILERÍA BLANCA



## PERFILERÍA TITANIO



Opción tirador extraplano negro 22x1,6x0,7 cm

Ref.	Puntos
9031	25

**PASO 1: Seleccionar medida/color de la PERFILERÍA**

**PASO 2: Seleccionar medida/decorado FIJO EN LÍNEA**

**PASO 3: Seleccionar medida/decorado de los FRONTALES**

**Rango = Rango Min/Max frontal + Medida fijo en línea**



### PASO 1: PERFILERÍA

Descripción	NEGRO		BLANCO		TITANIO	
	Ref.	Puntos	Ref.	Puntos	Ref.	Puntos
Accesorios frontal hasta 140 cm	5493+5467N	235	5583+5467B	235	5560+5467T	255
Accesorios frontal hasta 180 cm	5494+5467N	243	5584+5467B	243	5561+5467T	263
Accesorios frontal hasta 200 cm	5495+5467N	260	5585+5467B	260	5562+5467T	280

### PASO 2: FIJOS EN LÍNEA

Medida fijo	TRANSPARENTE		FROST PLUS	
	Ref.	Puntos	Ref.	Puntos
Fijo de 30 cm	5018F	73	6018F	89
Fijo de 35 cm	5019F	80	6019F	96
Fijo de 40 cm	5020F	84	6020F	100
Fijo de 45 cm	5021F	94	6021F	110
Fijo de 52 cm	5002F	100	6002F	115
Fijo de 55 cm	5022F	107	6022F	122
Fijo de 57 cm	5004F	111	6004F	126

### PASO 3: FRONTALES

Descripción	Rangos (cm)	TRANSPARENTE		FROST PLUS	
		Ref.	Puntos	Ref.	Puntos
Fijo + Puerta frontal de 100	95-100	5001	145	6001	172
Fijo + Puerta frontal de 105	100-105	5002	152	6002	179
Fijo + Puerta frontal de 110	105-110	5003	158	6003	185
Fijo + Puerta frontal de 115	110-115	5004	163	6004	192
Fijo + Puerta frontal de 120	115-120	5005	167	6005	199
Fijo + Puerta frontal de 125	120-125	5006	174	6006	206
Fijo + Puerta frontal de 130	125-130	5007	179	6007	213
Fijo + Puerta frontal de 135	130-135	5008	183	6008	218
Fijo + Puerta frontal de 140	135-140	5009	189	6009	225
Fijo + Puerta frontal de 145	140-145	5010	194	6010	232
Fijo + Puerta frontal de 150	145-150	5011	199	6011	239
Fijo + Puerta frontal de 155	150-155	5012	206	6012	246
Fijo + Puerta frontal de 160	155-160	5013	211	6013	253
Fijo + Puerta frontal de 165	160-165	5014	215	6014	257
Fijo + Puerta frontal de 170	165-170	5015L	217	6015L	276
Fijo + Puerta frontal de 175	170-175	5016L	223	6016L	284
Fijo + Puerta frontal de 180	175-180	5017L	229	6017L	291
Fijo + Puerta frontal de 190	180-190	5023L	239	6023L	306
Fijo + Puerta frontal de 200	190-200	5024L	250	6024L	321

A medida y especiales, ver pag. 280.

# BASIC FREE COLOR

## PERFILERÍA BLANCA



Perfilería con stopper antivuelco



Doble rodamiento regulable en nylon con antivuelco



Nuevo guiador optimizado con pulsador liberador de hoja

## PERFILERÍA TITANIO



## PERFILERÍA NEGRA



Opción tirador extraplano negro 22x1,6x0,7 cm

Ref.	Puntos
9031	25



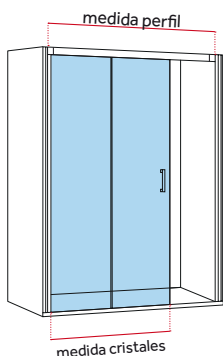
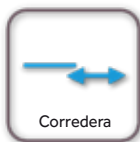

**PASO 1: Seleccionar medida/color de la PERFILERÍA**  
**PASO 2: Seleccionar medida/decorado de los FRONTALES**



**PASO 1: PERFILERÍA**

Descripción	NEGRO		BLANCO		TITANIO	
	Ref.	Puntos	Ref.	Puntos	Ref.	Puntos
Perf. y acc. hasta 140 + KIT FREE	5493+5447N	211	5583+5447B	211	5560+5447T	231
Perf. y acc. hasta 180 + KIT FREE	5494+5447N	219	5584+5447B	219	5561+5447T	239
Perf. y acc. hasta 200 + KIT FREE	5495+5447N	236	5585+5447B	236	5562+5447T	256

\*Desglose por referencias/punto en página 293.

**PASO 2: CRISTALES**

Rangos (cm)	TRANSPARENTE		FROST PLUS	
	Ref.	Puntos	Ref.	Puntos
Cristales de 95-100	5001	145	6001	172
Cristales de 100-105	5002	152	6002	179
Cristales de 105-110	5003	158	6003	185
Cristales de 110-115	5004	163	6004	192
Cristales de 115-120	5005	167	6005	199
Cristales de 120-125	5006	174	6006	206
Cristales de 125-130	5007	179	6007	213
Cristales de 130-135	5008	183	6008	218
Cristales de 135-140	5009	189	6009	225
Cristales de 140-145	5010	194	6010	232
Cristales de 145-150	5011	199	6011	239
Cristales de 150-155	5012	206	6012	246
Cristales de 155-160	5013	211	6013	253
Cristales de 160-165	5014	215	6014	257
Cristales de 165-170	5015L	217	6015L	276
Cristales de 170-175	5016L	223	6016L	284
Cristales de 175-180	5017L	229	6017L	291
Cristales de 180-190	5023L	239	6023L	306
Cristales de 190-200	5024L	250	6024L	321



	TRANSPARENTE	FROST PLUS PARSOL / MATE	CAJONADO
Mamparas a medida y cristales especiales	+45%	+60%	+21

\*Plazo de entrega 15 días (más información en pág. 280)



VETRUM pg.106



TEMPLE pg.118



ROTARY pg.126



FUTURA pg.134



MOVING pg.153



ACERO

**MAMPARAS  
ACERO  
CORREDERAS**

# vetrum

10/8mm

"Diseño y calidades  
insuperables con ausencia  
total de perfilera"





VETRUM

## VETRUM 1 fijo + 1 corredera





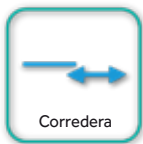

Frontales VETRUM 1fijo+1corredera

Descripción	Rango	Apertura	Referencias	Puntos
Frontal ducha VETRUM 115	113-118	39,7-44,3	1070	771
Frontal ducha VETRUM 120	117-122	40,7-45,7	1050	779
Frontal ducha VETRUM 125	122-127	40,7-45,7	1051	807
Frontal ducha VETRUM 130	127-132	45,7-50,7	1052	825
Frontal ducha VETRUM 135	132-137	45,7-50,7	1053	848
Frontal ducha VETRUM 140	137-142	50,7-55,7	1054	861
Frontal ducha VETRUM 145	142-147	50,7-55,7	1055	867
Frontal ducha VETRUM 150	147-152	55,7-60,7	1056	875
Frontal ducha VETRUM 155	152-157	55,7-60,7	1057	887
Frontal ducha VETRUM 160	157-162	60,7-65,7	1058	895
Frontal ducha VETRUM 165	162-167	60,7-65,7	1059	907
Frontal ducha VETRUM 170	167-172	65,7-70,7	1060	915
Frontal ducha VETRUM 175	172-177	60,7-65,7	1061	940
Frontal ducha VETRUM 180	177-182	65,7-70,7	1062	948
Perfil expansión +1 cm			1073	64
Opción cierre perfil inox + burbuja *Con este sistema el rango se reduce 2 cm			1072	65
Opción barra inox paralela hasta 2 m			5546	65



Guía y rodamiento inferior en acero



Rodamiento acero integrado



Opción barra paralela

## VETRUM FREE 1fijo + 1corredera



Descripción	Referencias	Puntos
Freno vetrum free	1071	17

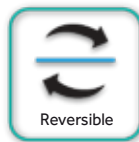
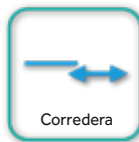
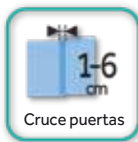

## Frontales VETRUM FREE

Descripción	Rango	Referencias	Puntos
Frontal ducha VETRUM FREE 115	111-116	1070 + 1071	788
Frontal ducha VETRUM FREE 120	115-120	1050 + 1071	796
Frontal ducha VETRUM FREE 125	120-125	1051 + 1071	824
Frontal ducha VETRUM FREE 130	125-130	1052 + 1071	842
Frontal ducha VETRUM FREE 135	130-135	1053 + 1071	865
Frontal ducha VETRUM FREE 140	135-140	1054 + 1071	878
Frontal ducha VETRUM FREE 145	140-145	1055 + 1071	884
Frontal ducha VETRUM FREE 150	145-150	1056 + 1071	892
Frontal ducha VETRUM FREE 155	150-155	1057 + 1071	904
Frontal ducha VETRUM FREE 160	155-160	1058 + 1071	912
Frontal ducha VETRUM FREE 165	160-165	1059 + 1071	924
Frontal ducha VETRUM FREE 170	165-170	1060 + 1071	932
Frontal ducha VETRUM FREE 175	170-175	1061 + 1071	957
Frontal ducha VETRUM FREE 180	175-180	1062 + 1071	965
Perfil expansión +1 cm		1073	64



Rodamiento acero integrado



Barra acero ext. 108 cm y orientable



Freno de corredera

## VETRUM SPAZIO 2 fijos + 2 correderas



Descripción	Referencias	Puntos
Kit conversión spazio	1071	17

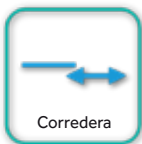
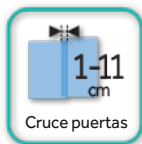

## Frontales VETRUM 2fijos+2correderas

Descripción	Rango	Apertura	Referencias	Puntos
VETRUM SPAZIO 2fijos+2correderas <b>150x202</b>	134-154	30-50	<b>1067+1067+1071</b>	<b>1185</b>
VETRUM SPAZIO 2fijos+2correderas <b>170x202</b>	154-174	40-60	<b>1068+1068+1071</b>	<b>1247</b>
VETRUM SPAZIO 2fijos+2correderas <b>190x202</b>	174-194	50-70	<b>1069+1069+1071</b>	<b>1351</b>
VETRUM SPAZIO 2fijos+2correderas <b>210x202</b>	213-233	69-89	<b>1070+1070+1071</b>	<b>1559</b>
Perfil expansión +1 cm			<b>1073</b>	<b>64</b>



Guía y rodamiento inferior en acero



Rodamiento acero integrado



Barra acero ext. 108 cm y orientable

## VETRUM angular al vértice



Descripción	Referencias	Puntos
lado VETRUM 70 1fijo+1corredera	1066	554
lado VETRUM 80 1fijo+1corredera	1067	584
lado VETRUM 90 1fijo+1corredera	1068	615
lado VETRUM 100 1fijo+1corredera	1069	667
lado VETRUM 120 1fijo+1corredera	1070	771



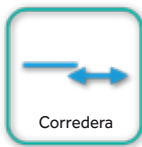
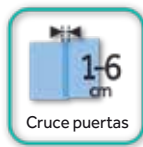

Combinaciones angular **VETRUM** apertura al vértice

Medidas	Rangos	Apertura	Referencias	Puntos
70x70	65-70/65-70	26-29	1066+1066	1108
80x70	75-80/65-70	29-32	1067+1066	1138
90x70	85-90/65-70	33-36	1068+1066	1169
100x70	95-100/65-70	37-40	1069+1066	1221
115x70	114-119/65-70	44-49	1070+1066	1325
120x70	118-123/65-70	44-49	1050+1066	1333
125x70	123-128/65-70	45-50	1051+1066	1361
130x70	128-133/65-70	49-54	1052+1066	1379
135x70	133-138/65-70	49-54	1053+1066	1402
140x70	138-143/65-70	55-60	1054+1066	1415
145x70	143-148/65-70	55-60	1055+1066	1421
150x70	148-153/65-70	59-64	1056+1066	1429
Medidas	Rangos	Apertura	Referencias	Puntos
80x80	75-80/ 75-80	33-36	1067+1067	1168
90x80	85-90/75-80	36-39	1068+1067	1199
100x80	95-100/75-80	40-43	1069+1067	1251
115x80	114-119/75-80	46-51	1070+1067	1355
120x80	118-123/75-80	46-51	1050+1067	1363
125x80	123-128/75-80	47-52	1051+1067	1391
130x80	128-133/75-80	51-56	1052+1067	1409
135x80	133-138/75-80	51-56	1053+1067	1432
140x80	138-143/75-80	56-61	1054+1067	1445
145x80	143-148/75-80	56-61	1055+1067	1451
150x80	148-153/75-80	60-65	1056+1067	1459
Medidas	Rangos	Apertura	Referencias	Puntos
90x90	85-90/85-90	40-43	1068+1068	1230
100x90	95-100/85-90	43-46	1069+1068	1282
115x90	114-119/85-90	51-54	1070+1068	1386
120x90	118-123/85-90	51-54	1050+1068	1394
125x90	123-128/85-90	50-55	1051+1068	1422
130x90	128-133/85-90	54-59	1052+1068	1440
135x90	133-138/85-90	54-59	1053+1068	1463
140x90	138-143/85-90	58-63	1054+1068	1476
145x90	143-148/85-90	58-63	1055+1068	1482
150x90	148-153/85-90	63-68	1056+1068	1490
Perfil expansión +1 cm			1073	64

## VETRUM frontal + lateral fijo



Descripción	Rango	Referencias	Puntos
Lateral fijo 70 VETRUM 10 mm + brazo	67-69	1063	348
Lateral fijo 75 VETRUM 10 mm + brazo	72-74	1115	358
Lateral fijo 80 VETRUM 10 mm + brazo	77-79	1064	367
Lateral fijo 90 VETRUM 10 mm + brazo	87-89	1065	386

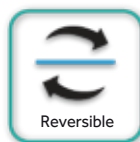
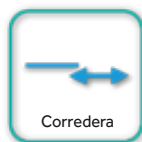
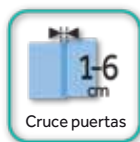

## Combinaciones VETRUM frontal + lateral fijo

Medidas	Rango	Referencias	Puntos	Medidas	Rango	Referencias	Puntos
115x70	113-117 / 67-69	1070 +1063	1119	115x75	113-117 / 72-74	1070 + 1115	1129
120x70	116-121 / 67-69	1050 +1063	1127	120x75	116-121 / 72-74	1050 + 1115	1137
125x70	121-126 / 67-69	1051 +1063	1155	125x75	121-126 / 72-74	1051 + 1115	1165
130x70	126-131 / 67-69	1052 +1063	1173	130x75	126-131 / 72-74	1052 + 1115	1183
135x70	131-136 / 67-69	1053 +1063	1196	135x75	131-136 / 72-74	1053 + 1115	1206
140x70	136-141 / 67-69	1054 +1063	1209	140x75	136-141 / 72-74	1054 + 1115	1219
145x70	141-146 / 67-69	1055 +1063	1215	145x75	141-146 / 72-74	1055 + 1115	1225
150x70	146-151 / 67-69	1056 +1063	1223	150x75	146-151 / 72-74	1056 + 1115	1233
155x70	151-156 / 67-69	1057 +1063	1235	155x75	151-156 / 72-74	1057 + 1115	1245
160x70	156-161 / 67-69	1058 +1063	1243	160x75	156-161 / 72-74	1058 + 1115	1253
165x70	161-166 / 67-69	1059 +1063	1255	165x75	161-166 / 72-74	1059 + 1115	1265
170x70	166-171 / 67-69	1060 +1063	1263	170x75	166-171 / 72-74	1060 + 1115	1273
175x70	171-176 / 67-69	1061 +1063	1288	175x75	171-176 / 72-74	1061 + 1115	1298
180x70	176-181 / 67-69	1062 +1063	1296	180x75	176-181 / 72-74	1062 + 1115	1306
115x80	113-117 / 77-79	1070 + 1064	1138	115x90	113-117 / 87-89	1070 + 1065	1157
120x80	116-121 / 77-79	1050 +1064	1146	120x90	116-121 / 87-89	1050 +1065	1165
125x80	121-126 / 77-79	1051 +1064	1174	125x90	121-126 / 87-89	1051 +1065	1193
130x80	126-131 / 77-79	1052 +1064	1192	130x90	126-131 / 87-89	1052 +1065	1211
135x80	131-136 / 77-79	1053 +1064	1215	135x90	131-136 / 87-89	1053 +1065	1234
140x80	136-141 / 77-79	1054 +1064	1228	140x90	136-141 / 87-89	1054 +1065	1247
145x80	141-146 / 77-79	1055 +1064	1234	145x90	141-146 / 87-89	1055 +1065	1253
150x80	146-151 / 77-79	1056 +1064	1242	150x90	146-151 / 87-89	1056 +1065	1261
155x80	151-156 / 77-79	1057 +1064	1254	155x90	151-156 / 87-89	1057 +1065	1273
160x80	156-161 / 77-79	1058 +1064	1262	160x90	156-161 / 87-89	1058 +1065	1281
165x80	161-166 / 77-79	1059 +1064	1274	165x90	161-166 / 87-89	1059 +1065	1293
170x80	166-171 / 77-79	1060 +1064	1282	170x90	166-171 / 87-89	1060 +1065	1301
175x80	171-176 / 77-79	1061 +1064	1307	175x90	171-176 / 87-89	1061 +1065	1326
180x80	176-181 / 77-79	1062 +1064	1315	180x90	176-181 / 87-89	1062 +1065	1334
1073	perfil expansión +1 cm		64				

\*Las aperturas son las mismas que en los frontales.

## Laterales fijos a medida (más información en página 282)



Descripción	Referencias	Puntos	Cajonado
Lateral fijo a medida VETRUM hasta 40 cm	1340	305	+21
Lateral fijo a medida VETRUM de 40 hasta 80 cm	1300	390	+21
Lateral fijo a medida VETRUM de 80 hasta 120 cm	1306	460	+21
Opción perfil unión fijo + lateral fijo (ver pág. 285)	1075	82	

\*Plazo de entrega 15 días

# temple

"La nobleza y resistencia del  
acero al alcance de todos"





TEMPLE



TEMPLE 1 fijo + 1 corredera





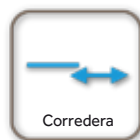

## Frontales TEMPLE 1fijo+1corredera

Medida	Apertura	TRANSPARENTE		FROST PLUS	
		Ref.	Puntos	Ref.	Puntos
95-100	36-41	5101	428	6101	455
100-105	36-41	5102	440	6102	467
105-110	41-46	5103	446	6103	473
110-115	41-46	5104	457	6104	486
115-120	46-51	5105	461	6105	493
120-125	46-51	5106	473	6106	505
125-130	51-56	5107	478	6107	512
130-135	51-56	5108	487	6108	522
135-140	56-61	5109	493	6109	529
140-145	56-61	5110	503	6110	541
145-150	61-66	5111	508	6111	548
150-155	61-66	5112	521	6112	561
155-160	61-66	5113	526	6113	568
160-165	61-66	5114	535	6114	577
165-170	66-71	5115	537	6115	596
*170-180	66-71	5117	554	6117	616
Perfil de compensación para parte fija + 1,5 cm				5179	31
Pletina embellecedora 195x3,8cm				0008	41

\*Cruce de puertas 1-11 cm

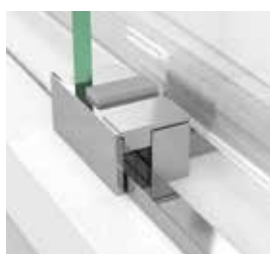

Nuevo guía optimizado con pulsador liberador de hoja para facilitar la limpieza



Doble rodamiento última generación nylon



Opción pletina embellecedora

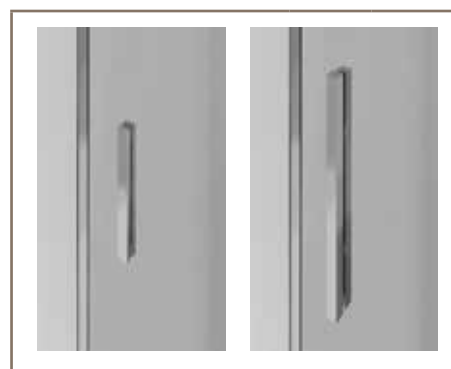

Opción tirador	Ref.	Puntos
Extraplano 22x1,6x0,7 cm	1731	20
Largo 40x1,2x1,5 cm	1732	33



Mamparas a medida y cristales especiales	TRANSPARENTE	FROST PLUS PARSOL / MATE
Altura hasta 195 cm	+45%	+60%

\*Plazo de entrega 15 días (más información en pág. 280)

# TEMPLE angular al vértice



Descripción	TRANSPARENTE		FROST PLUS	
	Ref.	Puntos	Ref.	Puntos
Lado TEMPLE 70 1fijo+1corredera	5118	305	6118	326
Lado TEMPLE 75 1fijo+1corredera	5129	312	6129	334
Lado TEMPLE 80 1fijo+1corredera	5119	317	6119	338
Lado TEMPLE 90 1fijo+1corredera	5120	331	6120	352
Lado TEMPLE 100 1fijo+1corredera	5121	323	6121	350
Lado TEMPLE 120 1fijo+1corredera	5122	349	6122	386
Corner kit unión lado + lado	5123	41		
Corner kit unión frontal + lado	5124	26		

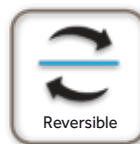
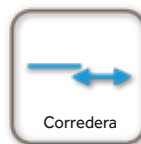

combinaciones angular TEMPLE apertura al vértice

Medida	Rangos	Apert.	TRANSPARENTE		FROST PLUS	
			Referencias	Puntos	Referencias	Puntos
70x70	65-70 / 65-70	34-37	5118+5118+5123	651	6118+6118+5123	693
75x70	70-75 / 65-70	36-39	5129+5118+5123	658	6129+6118+5123	701
80x70	75-80 / 65-70	38-41	5119+5118+5123	663	6119+6118+5123	705
90x70	85-90 / 65-70	42-45	5120+5118+5123	677	6120+6118+5123	719
100x70	95-100 / 65-70	46-49	5121+5118+5123	669	6121+6118+5123	717
110x70	104-109 / 65-70	47-50	5102+5118+5124	771	6102+6118+5124	819
120x70	115-120 / 65-70	50-53	5122+5118+5123	695	6122+6118+5123	753
130x70	125-129 / 65-70	55-58	5106+5118+5124	804	6106+6118+5124	857
140x70	135-139 / 65-70	59-62	5108+5118+5124	818	6108+6118+5124	874
Medida	Rangos	Apert.	Referencias	Puntos	Referencias	Puntos
75x75	70-75 / 70-75	38-41	5129+5129+5123	665	6129+6129+5123	709
80x75	75-80 / 70-75	40-43	5119+5129+5123	670	6119+6129+5123	713
90x75	85-90 / 70-75	45-48	5120+5129+5123	684	6120+6129+5123	727
100x75	95-100 / 70-75	48-51	5121+5129+5123	676	6121+6129+5123	725
110x75	104-109 / 70-75	49-52	5102+5129+5124	778	6102+6129+5124	827
120x75	115-120 / 70-75	52-55	5122+5129+5123	702	6122+6129+5123	761
130x75	125-129 / 70-75	57-60	5106+5129+5124	811	6106+6129+5124	865
140x75	135-139 / 70-75	61-64	5108+5129+5124	825	6108+6129+5124	882
Medida	Rangos	Apert.	Referencias	Puntos	Referencias	Puntos
80x80	75-80 / 75-80	41-44	5119+5119+5123	675	6119+6119+5123	717
90x80	85-90 / 75-80	45-48	5120+5119+5123	689	6120+6119+5123	731
100x80	95-100 / 75-80	49-52	5121+5119+5123	681	6121+6119+5123	729
110x80	104-109 / 75-80	50-53	5102+5119+5124	783	6102+6119+5124	831
120x80	115-120 / 75-80	53-56	5122+5119+5123	707	6122+6119+5123	765
130x80	125-129 / 75-80	57-61	5106+5119+5124	816	6106+6119+5124	869
140x80	135-139 / 75-80	62-65	5108+5119+5124	830	6108+6119+5124	886
Medida	Rangos	Apert.	Referencias	Puntos	Referencias	Puntos
90x90	85-90 / 85-90	48-51	5120+5120+5123	703	6120+6120+5123	745
100x90	95-100 / 85-90	52-55	5121+5120+5123	695	6121+6120+5123	743
110x90	104-109 / 85-90	53-56	5102+5120+5124	797	6102+6120+5124	845
120x90	115-120 / 85-90	55-58	5122+5120+5123	721	6122+6120+5123	779
130x90	125-129 / 85-90	61-63	5106+5120+5124	830	6106+6120+5124	883
140x90	135-139 / 85-90	64-67	5108+5120+5124	844	6108+6120+5124	900

\*Se pueden combinar medidas intermedias. El rango resultante aumenta 4 cm respecto al rango del frontal

Descripción	Referencias	Puntos
Perfil de compensación +1,5 cm	5179	31



Mamparas a medida y cristales especiales	TRANSPARENTE	FROST PLUS PARSOL / MATE	CAJONADO
Altura hasta 195 cm	+45%	+60%	+21

\*Plazo de entrega 15 días (más información en pág. 280)

# TEMPLE frontal + lateral fijo de 8 mm



Descripción	Rango	TRANSPARENTE		FROST PLUS	
		Ref.	Puntos	Ref.	Puntos
Lateral fijo TEMPLE 70	67-69	5125	209	6125	231
Lateral fijo TEMPLE 75	72-74	5157	213	6157	241
Lateral fijo TEMPLE 80	77-79	5126	220	6126	248
Lateral fijo TEMPLE 90	87-89	5127	232	6127	260



## Laterales fijos a medida

Descripción	TRANSPARENTE		FROST PLUS		Cajonado
	Ref.	Puntos	Ref.	Puntos	
Lateral fijo a medida hasta 40 cm	1349	206	1349+1312	328	+21
Lateral fijo a medida de 40 hasta 80 cm	1302	286	1302+1313	408	+21
Lateral fijo a medida de 80 hasta 120 cm	1308	356	1308+1315	478	+21

\*Plazo de entrega 15 días (más información en página 282)

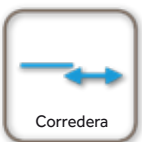

frontales + lateral fijo de 8 mm

Medidas	Rangos	TRANSPARENTE		FROST PLUS	
		Referencias	Puntos	Referencias	Puntos
100x70	95-100/67-69	5101+5125	637	6101+6125	686
110x70	105-110/67-69	5103+5125	655	6103+6125	704
120x70	115-120/67-69	5105+5125	670	6105+6125	724
130x70	125-130/67-69	5107+5125	687	6107+6125	743
140x70	135-140/67-69	5109+5125	702	6109+6125	760
150x70	145-150/67-69	5111+5125	717	6111+6125	779
160x70	155-160/67-69	5113+5125	735	6113+6125	799
170x70	165-170/67-69	5115+5125	746	6115+6125	827
*180x70	170-180/67-69	5117+5125	763	6117+6125	847
100x75	95-100/72-74	5101+5157	641	6101+6157	696
110x75	105-110/72-74	5103+5157	659	6103+6157	714
120x75	115-120/72-74	5105+5157	674	6105+6157	734
130x75	125-130/72-74	5107+5157	691	6107+6157	753
140x75	135-140/72-74	5109+5157	706	6109+6157	770
150x75	145-150/72-74	5111+5157	721	6111+6157	789
160x75	155-160/72-74	5113+5157	739	6113+6157	809
170x75	165-170/72-74	5115+5157	750	6115+6157	837
*180x75	170-180/72-74	5117+5157	767	6117+6157	857
100x80	95-100/77-79	5101+5126	648	6101+6126	703
110x80	105-110/77-79	5103+5126	666	6103+6126	721
120x80	115-120/77-79	5105+5126	681	6105+6126	741
130x80	125-130/77-79	5107+5126	698	6107+6126	760
140x80	135-140/77-79	5109+5126	713	6109+6126	777
150x80	145-150/77-79	5111+5126	728	6111+6126	796
160x80	155-160/77-79	5113+5126	746	6113+6126	816
170x80	165-170/77-79	5115+5126	757	6115+6126	844
*180x80	170-180/77-79	5117+5126	774	6117+6126	864
100x90	95-100/87-89	5101+5127	660	6101+6127	715
110x90	105-110/87-89	5103+5127	678	6103+6127	733
120x90	115-120/87-89	5105+5127	693	6105+6127	753
130x90	125-130/87-89	5107+5127	710	6107+6127	772
140x90	135-140/87-89	5109+5127	725	6109+6127	789
150x90	145-150/87-89	5111+5127	740	6111+6127	808
160x90	155-160/87-89	5113+5127	758	6113+6127	828
170x90	165-170/87-89	5115+5127	769	6115+6127	856
*180x90	170-180/87-89	5117+5127	786	6117+6127	876

Se pueden hacer otras combinaciones con medidas intermedias de frontales  
 \*Cruce de puertas 1-11 cm

Descripción	Referencias	Puntos
Perfil de compensación +1,5 cm (sólo válido para frontal)	5179	31
Perfil unión fijo-fijo (más información pág. 285)	1075	82



# rotary

"Elegante combinación de líneas rectas y circulares en acero"







ROTARY

# ROTARY 1fijo + 1corredera



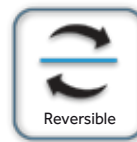
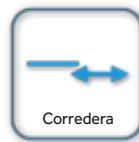
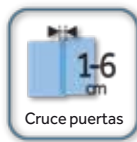

## Frontales ROTARY 1fijo+1corredera

Medida	Apertura	TRANSPARENTE		FROST PLUS	
		Ref.	Puntos	Ref.	Puntos
95-100	36 - 41	5201	478	6201	505
100-105	36 - 41	5202	490	6202	517
105-110	41 - 46	5203	496	6203	523
110-115	41 - 46	5204	506	6204	535
115-120	46 - 51	5205	510	6205	542
120-125	46 - 51	5206	522	6206	554
125-130	51 - 56	5207	527	6207	561
130-135	51 - 56	5208	536	6208	571
135-140	56 - 61	5209	542	6209	578
140-145	56 - 61	5210	552	6210	590
145-150	61 - 66	5211	557	6211	597
150-155	61 - 66	5212	569	6212	609
155-160	61 - 66	5213	574	6213	616
160-165	61 - 66	5214	583	6214	625
165-170	66 - 71	5215	585	6215	644
*170-180	66 - 71	5217	602	6217	664
Perfil de compensación para parte fija + 1,5 cm				5179	31
Pletina embellecedora 193,7x3,4 cm				0008	41

\*Cruce de puertas 1-11 cm

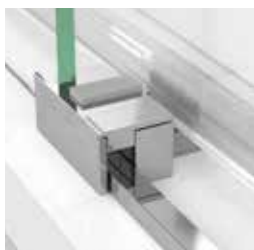

Nuevo guiador optimizado con pulsador liberador de hoja para facilitar la limpieza



Innovador rodamiento con guiador antivuelco



Opción pletina embellecedora



Opción tirador	Ref.	Puntos
Extraplano 22x1,6x0,7 cm	1731	20
Largo 40x1,2x1,5 cm	1732	33



Mamparas a medida y cristales especiales	TRANSPARENTE	FROST PLUS PARSOL / MATE
Altura hasta 197 cm	+45%	+60%

\*Plazo de entrega 15 días (más información en pág. 280)

## ROTARY angular al vértice



Descripción	TRANSPARENTE		FROST PLUS	
	Ref.	Puntos	Ref.	Puntos
Lado ROTARY 70 1fijo+1corredera	5218	399	6218	420
Lado ROTARY 75 1fijo+1corredera	5229	404	6229	426
Lado ROTARY 80 1fijo+1corredera	5219	409	6219	430
Lado ROTARY 90 1fijo+1corredera	5220	420	6220	441
Lado ROTARY 100 1fijo+1corredera	5221	425	6221	452
Lado ROTARY 120 1fijo+1corredera	5222	451	6222	488
Corner kit unión lado + lado	5223	45		
Corner kit unión frontal + lado	5224	28		

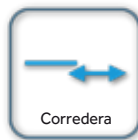

combinaciones angular **ROTARY** apertura al vértice

Medida	Rangos	Apertura	TRANSPARENTE		FROST PLUS	
			Referencias	Puntos	Referencias	Puntos
70x70	65-70 / 65-70	34 - 37	5218+5218+5223	847	6218+6218+5223	889
75x70	70-75 / 65-70	36 - 39	5229+5218+5223	857	6229+6218+5223	900
80x70	75-80 / 65-70	38 - 41	5219+5218+5223	878	6219+6218+5223	904
90x70	85-90 / 65-70	42 - 45	5220+5218+5223	862	6220+6218+5223	920
100x70	95-100 / 65-70	46 - 49	5221+5218+5223	871	6221+6218+5223	919
110x70	104-109 / 65-70	47 - 50	5202+5218+5224	919	6202+6218+5224	967
120x70	115-120 / 65-70	50 - 53	5222+5218+5223	897	6222+6218+5223	955
Medida	Rangos	Apertura	Referencias	Puntos	Referencias	Puntos
75x75	70-75 / 70-75	38 - 41	5229+5229+5223	867	6229+6229+5223	911
80x75	75-80 / 70-75	40 - 43	5219+5229+5223	872	6219+6229+5223	915
90x75	85-90 / 70-75	45 - 48	5220+5229+5223	888	6220+6229+5223	931
100x75	95-100 / 70-75	48 - 51	5221+5229+5223	881	6221+6229+5223	930
110x75	104-109 / 70-75	49 - 52	5202+5229+5224	929	6202+6229+5224	978
120x75	115-120 / 70-75	52 - 55	5222+5229+5223	907	6222+6229+5223	966
Medida	Rangos	Apertura	Referencias	Puntos	Referencias	Puntos
80x80	75-80 / 75-80	41 - 44	5219+5219+5223	877	6219+6219+5223	919
90x80	85-90 / 75-80	45 - 48	5220+5219+5223	893	6220+6219+5223	935
100x80	95-100 / 75-80	49 - 52	5221+5219+5223	886	6221+6219+5223	934
110x80	104-109 / 75-80	50 - 53	5202+5219+5224	934	6202+6219+5224	982
120x80	115-120 / 75-80	53 - 56	5222+5219+5223	912	6222+6219+5223	970
Medida	Rangos	Apertura	Referencias	Puntos	Referencias	Puntos
90x90	85-90 / 85-90	48 - 51	5220+5220+5223	909	6220+6220+5223	951
100x90	95-100 / 85-90	52 - 55	5221+5220+5223	902	6221+6220+5223	950
110x90	104-109 / 85-90	53 - 56	5202+5220+5224	950	6202+6220+5224	998
120x90	115-120 / 85-90	55 - 58	5222+5220+5223	928	6222+6220+5223	986

Descripción	Referencias	Puntos
Perfil de compensación +1,5 cm	5179	31



Mamparas a medida y cristales especiales	TRANSPARENTE	FROST PLUS PARSOL / MATE	CAJONADO
Altura hasta 197 cm	+45%	+60%	+21

\*Plazo de entrega 15 días (más información en pág. 280)

# ROTARY frontal + lateral fijo de 8 mm



Descripción	Rango	TRANSPARENTE		FROST PLUS	
		Ref.	Puntos	Ref.	Puntos
Lateral fijo ROTARY 70	67 - 69	5225	210	6225	232
Lateral fijo ROTARY 75	72 - 74	5257	214	6257	242
Lateral fijo ROTARY 80	77 - 79	5226	221	6226	249
Lateral fijo ROTARY 90	87 - 89	5227	233	6227	261

Descripción	TRANSPARENTE		FROST PLUS		Cajonado
	Ref.	Puntos	Ref.	Puntos	
Lateral fijo a medida hasta 40 cm	1348	206	1348+1312	328	+21
Lateral fijo a medida de 40 hasta 80 cm	1332	286	1332+1313	408	+21
Lateral fijo a medida de 80 hasta 120 cm	1333	356	1333+1315	478	+21

\*Plazo de entrega 15 días (más información en página 282)



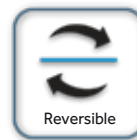
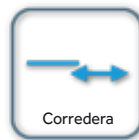

## Frontales + lateral fijo de 8 mm

		TRANSPARENTE		FROST PLUS	
Medidas	Rangos	Referencias	Puntos	Referencias	Puntos
100x70	95-100/67-69	5201+5225	688	6201+6225	737
110x70	105-110/67-69	5203+5225	706	6203+6225	755
120x70	115-120/67-69	5205+5225	720	6205+6225	774
130x70	125-130/67-69	5207+5225	737	6207+6225	793
140x70	135-140/67-69	5209+5225	752	6209+6225	810
150x70	145-150/67-69	5211+5225	767	6211+6225	829
160x70	155-160/67-69	5213+5225	784	6213+6225	848
170x70	165-170/67-69	5215+5225	795	6215+6225	876
*180x70	170-180/67-69	5217+5225	812	6217+6225	896
100x75	95-100/72-74	5201+5257	692	6201+6257	747
110x75	105-110/72-74	5203+5257	710	6203+6257	765
120x75	115-120/72-74	5205+5257	724	6205+6257	784
130x75	125-130/72-74	5207+5257	741	6207+6257	803
140x75	135-140/72-74	5209+5257	756	6209+6257	820
150x75	145-150/72-74	5211+5257	771	6211+6257	839
160x75	155-160/72-74	5213+5257	788	6213+6257	858
170x75	165-170/72-74	5215+5257	799	6215+6257	886
*180x75	170-180/72-74	5217+5257	816	6217+6257	906
100x80	95-100/77-79	5201+5226	699	6201+6226	754
110x80	105-110/77-79	5203+5226	717	6203+6226	772
120x80	115-120/77-79	5205+5226	731	6205+6226	791
130x80	125-130/77-79	5207+5226	748	6207+6226	810
140x80	135-140/77-79	5209+5226	763	6209+6226	827
150x80	145-150/77-79	5211+5226	778	6211+6226	846
160x80	155-160/77-79	5213+5226	795	6213+6226	865
170x80	165-170/77-79	5215+5226	806	6215+6226	893
*180x80	170-180/77-79	5217+5226	823	6217+6226	913
100x90	95-100/87-89	5201+5227	711	6201+6227	766
110x90	105-110/87-89	5203+5227	729	6203+6227	784
120x90	115-120/87-89	5205+5227	743	6205+6227	803
130x90	125-130/87-89	5207+5227	760	6207+6227	822
140x90	135-140/87-89	5209+5227	775	6209+6227	839
150x90	145-150/87-89	5211+5227	790	6211+6227	858
160x90	155-160/87-89	5213+5227	807	6213+6227	877
170x90	165-170/87-89	5215+5227	818	6215+6227	905
*180x90	170-180/87-89	5217+5227	835	6217+6227	925

Se pueden hacer otras combinaciones con medidas intermedias de frontales. \*Cruce de puertas 1-11 cm.

Descripción	Referencias	Puntos
Perfil de compensación +1,5 cm (sólo válido para frontal)	5179	31
Perfil unión fijo - fijo (más información pág. 285)	1075	82

# futura

"Combinación de barra de  
acero y rodamientos ocultos  
con estilo propio"





FUTURA

FUTURA 1fijo + 1corredera





H200

Altura

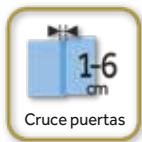

1-6 cm

Cruce puertas



6 mm

Grosor cristal

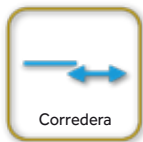

Corredera



Cierre burbuja



Reversible



STAINLESS  
INOX  
STEEL



antical  
clear  
shield  
glass

frontales FUTURA 1fijo+1corredera

Medida	Apertura	TRANSPARENTE		FROST PLUS	
		Ref.	Puntos	Ref.	Puntos
95-100	36-41	5301	445	6301	472
100-105	36-41	5302	452	6302	479
105-110	41-46	5303	458	6303	485
110-115	41-46	5304	463	6304	492
115-120	46-51	5305	467	6305	499
120-125	46-51	5306	474	6306	506
125-130	51-56	5307	479	6307	513
130-135	51-56	5308	483	6308	518
135-140	56-61	5309	489	6309	525
140-145	56-61	5310	504	6310	542
145-150	61-66	5311	509	6311	549
150-155	61-66	5312	516	6312	556
155-160	61-66	5313	521	6313	563
160-165	61-66	5314	525	6314	567
165-170	66-71	5315	527	6315	586
170-175	66-71	5316	533	6316	594
175-180	66-71	5317	539	6317	601
Perfil de compensación para parte fija + 1,5 cm				5179	31
Pletina embellecedora 195x3,8 cm				0008	41

Desglose por referencias/punto en página 293.



Perfilería y accesorios en acero inoxidable



Revolucionario sistema de cuatro ruedas por rodamiento



Opción pletina embellecedora

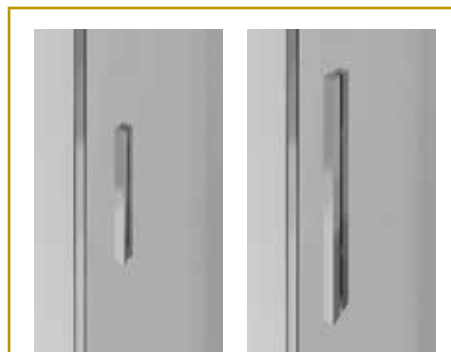

Opción tirador	Ref.	Puntos
Extraplano 22x1,6x0,7 cm	1731	20
Largo 40x1,2x1,5 cm	1732	33



Mamparas a medida y cristales especiales

Altura hasta 200 cm

TRANSPARENTE

+45%

FROST PLUS  
PARSOL / MATE

+60%

\*Plazo de entrega 15 días

## FUTURA SPAZIO 2fijos + 2correderas



Descripción	Rango	Apertura	Cruce	Referencias	Puntos
FUTURA SPAZIO 140 (75+75)	132-142	46-56	1-6	5029x2+5351	672
FUTURA SPAZIO 150 (80+80)	142-152	56-66	1-6	5019x2+5351	682
FUTURA SPAZIO 160 (85+85)	152-162	54-64	1-6	5030x2+5351	694
FUTURA SPAZIO 170 (90+90)	162-172	66-76	1-6	5020x2+5351	704
FUTURA SPAZIO 180 (95+95)	172-182	62-72	1-6	5031x2+5354	720
FUTURA SPAZIO 190 (100+100)	182-192	76-86	1-6	5021x2+5354	724
FUTURA SPAZIO 200 (100+100)	190-200	76-86	1-6	5001x2+5354	730
FUTURA SPAZIO 210 (105+105)	200-210	76-86	1-6	5002x2+5354	744

Desglose por referencias/punto en página 293.

Descripción	Referencias	Puntos
Perfil de compensación +1,5 cm	5179	31





# FUTURA SPAZIO FROST PLUS 2fijos + 2correderas



Descripción	Rango	Apertura	Cruce	Referencias	Puntos
FUTURA SPAZIO FROST PLUS 140 (75+75)	132-142	46-56	1-6	6029x2+5351	716
FUTURA SPAZIO FROST PLUS 150 (80+80)	142-152	56-66	1-6	6019x2+5351	724
FUTURA SPAZIO FROST PLUS 160 (85+85)	152-162	54-64	1-6	6030x2+5351	736
FUTURA SPAZIO FROST PLUS 170 (90+90)	162-172	66-76	1-6	6020x2+5351	746
FUTURA SPAZIO FROST PLUS 180 (95+95)	172-182	62-72	1-6	6031x2+5354	766
FUTURA SPAZIO FROST PLUS 190 (100+100)	182-192	76-86	1-6	6021x2+5354	778
FUTURA SPAZIO FROST PLUS 200 (100+100)	190-200	76-86	1-6	6001x2+5354	784
FUTURA SPAZIO FROST PLUS 210 (105+105)	200-210	76-86	1-6	6002x2+5354	798

Desglose por referencias/punto en página 293.

Descripción	Referencias	Puntos
Perfil de compensación +1,5 cm	5179	31



# FUTURA angular al vértice



Perfilería y accesorios en acero inoxidable



Revolucionario sistema de cuatro ruedas por rodamiento



Guiador y vierteaguas en acero



Tirador metálico



Medidas	Rangos	Apertura
70x70	65-70 / 65-70	34-37
75x70	70-75 / 65-70	36-39
80x70	75-80 / 65-70	38-41
85x70	80-85 / 65-70	40-43
90x70	85-90 / 65-70	43-45
95x70	90-95 / 65-70	45-47
100x70	95-100 / 65-70	46-49
110x70	104-109 / 65-70	47-50
120x70	115-120 / 65-70	50-53
Medidas	Rangos	Apertura
75x75	70-75 / 70-75	38-41
80x75	75-80 / 70-75	40-43
85x75	80-85 / 70-75	45-47
90x75	85-90 / 70-75	45-48
95x75	90-95 / 70-75	47-50
100x75	95-100 / 70-75	48-51
110x75	104-109 / 70-75	49-52
120x75	115-120 / 70-75	52-55
Medidas	Rangos	Apertura
80x80	75-80 / 75-80	41-44
85x80	80-85 / 75-80	43-46
90x80	85-90 / 75-80	45-48
95x80	90-95 / 75-80	50-52
100x80	95-100 / 75-80	49-52
110x80	104-109 / 75-80	50-53
120x80	115-120 / 75-80	53-56
Medidas	Rangos	Apertura
85x90	80-85 / 85-90	46-49
90x90	85-90 / 85-90	48-51
95x90	90-95 / 85-90	50-53
100x90	95-100 / 85-90	52-55
110x90	104-109 / 85-90	53-56
120x90	115-120 / 85-90	55-58

TRANSPARENTE	
Referencias	Puntos
5018+5018+5323	707
5029+5018+5323	712
5019+5018+5323	717
5030+5018+5323	723
5020+5018+5323	728
5031+5018+5323	731
5021+5018+5323	733
5002+5018+5323	743
5022+5018+5323	754
Referencias	Puntos
5029+5029+5323	717
5019+5029+5323	722
5030+5029+5323	728
5020+5029+5323	733
5031+5029+5323	736
5021+5029+5323	738
5002+5029+5323	748
5022+5029+5323	759
Referencias	Puntos
5019+5019+5323	727
5030+5019+5323	733
5020+5019+5323	738
5031+5019+5323	741
5021+5019+5323	743
5002+5019+5323	753
5022+5019+5323	764
Referencias	Puntos
5030+5020+5323	744
5020+5020+5323	749
5031+5020+5323	752
5021+5020+5323	754
5002+5020+5323	764
5022+5020+5323	775

FROST PLUS	
Referencias	Puntos
6018+6018+5323	749
6029+6018+5323	755
6019+6018+5323	759
6030+6018+5323	765
6020+6018+5323	770
6031+6018+5323	775
6021+6018+5323	781
6002+6018+5323	791
6022+6018+5323	812
Referencias	Puntos
6029+6029+5323	761
6019+6029+5323	765
6030+6029+5323	771
6020+6029+5323	776
6031+6029+5323	781
6021+6029+5323	787
6002+6029+5323	797
6022+6029+5323	818
Referencias	Puntos
6019+6019+5323	769
6030+6019+5323	775
6020+6019+5323	780
6031+6019+5323	785
6021+6019+5323	791
6002+6019+5323	801
6022+6019+5323	822
Referencias	Puntos
6030+6020+5323	786
6020+6020+5323	791
6031+6020+5323	796
6021+6020+5323	802
6002+6020+5323	812
6022+6020+5323	833

\*Desglose por referencias/punto en página 293.

Descripción	Referencias	Puntos
Perfil de compensación +1,5 cm	5179	31



Mamparas a medida y cristales especiales	TRANSPARENTE	FROST PLUS PARSOL / MATE	CAJONADO
Altura hasta 200 cm	+45%	+60%	+21

\*Plazo de entrega 15 días (más información en pág. 280)

# FUTURA frontal + lateral fijo de 8 mm



Descripción	Rango	TRANSPARENTE		FROST PLUS	
		Ref.	Puntos	Ref.	Puntos
Lateral fijo FUTURA 70	67-69	5325	263	6325	285
Lateral fijo FUTURA 75	72-74	5357	267	6357	295
Lateral fijo FUTURA 80	77-79	5326	274	6326	302
Lateral fijo FUTURA 90	87-89	5327	286	6327	314

Descripción	TRANSPARENTE		FROST PLUS		Cajonado
	Ref.	Puntos	Ref.	Puntos	
Lateral fijo a medida hasta 40 cm	1347	229	1347+1312	351	+21
Lateral fijo a medida de 40 hasta 80 cm	1330	309	1330+1313	431	+21
Lateral fijo a medida de 80 hasta 120 cm	1331	379	1331+1315	501	+21

\*Plazo de entrega 15 días (más información en página 282)

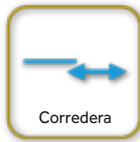

frontales + lateral fijo de 8 mm

		TRANSPARENTE		FROST PLUS	
Medidas	Rangos	Referencias	Puntos	Referencias	Puntos
100x70	95-100/67-69	5301+5325	708	6301+6325	757
110x70	105-110/67-69	5303+5325	721	6303+6325	770
120x70	115-120/67-69	5305+5325	730	6305+6325	784
130x70	125-130/67-69	5307+5325	742	6307+6325	798
140x70	135-140/67-69	5309+5325	752	6309+6325	810
150x70	145-150/67-69	5311+5325	772	6311+6325	834
160x70	155-160/67-69	5313+5325	784	6313+6325	848
170x70	165-170/67-69	5315+5325	790	6315+6325	871
180x70	175-180/67-69	5317+5325	802	6317+6325	886
Medidas	Rangos	Referencias	Puntos	Referencias	Puntos
100x75	95-100/72-74	5301+5357	712	6301+6357	767
110x75	105-110/72-74	5303+5357	725	6303+6357	780
120x75	115-120/72-74	5305+5357	734	6305+6357	794
130x75	125-130/72-74	5307+5357	746	6307+6357	808
140x75	135-140/72-74	5309+5357	756	6309+6357	820
150x75	145-150/72-74	5311+5357	776	6311+6357	844
160x75	155-160/72-74	5313+5357	788	6313+6357	858
170x75	165-170/72-74	5315+5357	794	6315+6357	881
180x75	175-180/72-74	5317+5357	806	6317+6357	896
Medidas	Rangos	Referencias	Puntos	Referencias	Puntos
100x80	95-100/77-79	5301+5326	719	6301+6326	774
110x80	105-110/77-79	5303+5326	732	6303+6326	787
120x80	115-120/77-79	5305+5326	741	6305+6326	801
130x80	125-130/77-79	5307+5326	753	6307+6326	815
140x80	135-140/77-79	5309+5326	763	6309+6326	827
150x80	145-150/77-79	5311+5326	783	6311+6326	851
160x80	155-160/77-79	5313+5326	795	6313+6326	865
170x80	165-170/77-79	5315+5326	801	6315+6326	888
180x80	175-180/77-79	5317+5326	813	6317+6326	903
Medidas	Rangos	Referencias	Puntos	Referencias	Puntos
100x90	95-100/87-89	5301+5327	731	6301+6327	786
110x90	105-110/87-89	5303+5327	744	6303+6327	799
120x90	115-120/87-89	5305+5327	753	6305+6327	813
130x90	125-130/87-89	5307+5327	765	6307+6327	827
140x90	135-140/87-89	5309+5327	775	6309+6327	839
150x90	145-150/87-89	5311+5327	795	6311+6327	863
160x90	155-160/87-89	5313+5327	807	6313+6327	877
170x90	165-170/87-89	5315+5327	813	6315+6327	900
180x90	175-180/87-89	5317+5327	825	6317+6327	915

\*Se pueden hacer otras combinaciones con medidas intermedias de frontales

Descripción	Referencias	Puntos
Perfil de compensación +1,5 cm (sólo válido para frontal)	5179	31



# moving

## 8mm

"Diseño clásico y elegante en  
acero para los más exigentes"







MOVING

# MOVING 1fijo + 1corredera





H199

Altura



1-6  
cm

Cruce puertas



8mm

Grosor cristal

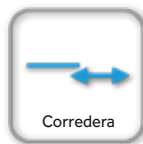

Corredera



Magnético

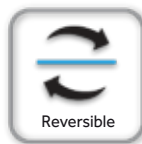

Reversible



STAINLESS  
INOX  
STEEL



antical  
clear  
shield  
glass

## Frontales MOVING 1fijo+1corredera

Descripción	Rango	Apertura	Referencias	Puntos
Frontal ducha MOVING 100	97-102	40-45	1003	610
Frontal ducha MOVING 105	102 -107	40-45	1103	668
Frontal ducha MOVING 110	107-112	45-50	1004	673
Frontal ducha MOVING 115	112-117	42-47	1104	691
Frontal ducha MOVING 120	117-122	47-52	1005	697
Frontal ducha MOVING 125	122-127	52-57	1105	723
Frontal ducha MOVING 130	127-132	47-52	1006	756
Frontal ducha MOVING 135	132-137	52-57	1106	782
Frontal ducha MOVING 140	137-142	57-62	1007	798
Frontal ducha MOVING 145	142-147	52-57	1107	817
Frontal ducha MOVING 150	147-152	57-62	1008	833
Frontal ducha MOVING 155	152-157	57-62	1108	852
Frontal ducha MOVING 160	157-162	62-67	1009	860
Frontal ducha MOVING 165	162-167	67-72	1109	881
Frontal ducha MOVING 170	167-172	62-67	1010	887
Frontal ducha MOVING 175	172-177	67-72	1110	908
Frontal ducha MOVING 180	177-182	67-72	1011	936
Perfil expansión + 1 cm			1074	62
Opción cierre perfil + junta burbuja *Con este sistema el rango se reduce 2 cm			1072	65



Guía y vierteaguas acero



Barra y herrajes acero



Tirador metálico



Perfilería acero



# MOVING SPAZIO 2fijos + 2correderas





H199

Altura



1-6  
cm

Cruce puertas



8mm

Grosor cristal

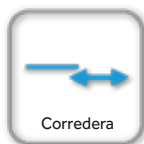

Corredera



Magnético

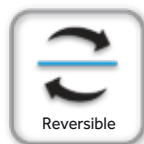

Reversible



STAINLESS  
INOX  
STEEL



tratamiento antical  
clear  
shield  
glass

### Frontales MOVING 2fijos+2correderas

Descripción	Rango	Apertura	Referencias	Puntos
Frontal ducha MOVING STEEL SPAZIO 160	152-162	51-61	1012	1002
Frontal ducha MOVING STEEL SPAZIO 170	162-172	61-71	1013	1033
Frontal ducha MOVING STEEL SPAZIO 180	172-182	61-71	1014	1062
Perfil de compensación +1 cm			1074	62



Perfilería acero



Barra y herrajes acero



Tirador metálico



Guía y vierteaguas acero

## MOVING angular al vértice



Descripción	Referencias	Puntos
Lado MOVING 70 1fijo+1corredera	1000	426
Lado MOVING 80 1fijo+1corredera	1001	483
Lado MOVING 90 1fijo+1corredera	1002	540
Lado MOVING 100 1fijo+1corredera	1102	597

Descripción	Referencias	Puntos
Kit conversión en angular	1017	38





H199

Altura



1-6  
cm

Cruce puertas



8mm

Grosor cristal

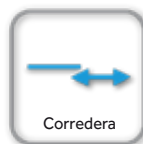

Corredera



Magnético

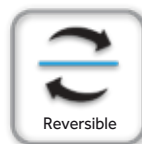

Reversible



STAINLESS  
INOX  
STEEL



antical  
clear  
shield  
glass

## combinaciones MOVING apertura al vértice

Medidas	Rangos	Apertura	Referencias	Puntos
70x70	66-70/66-70	34-36	1000+1000+1017	890
80x70	76-80/66-70	38-40	1001+1000+1017	947
90x70	86-90/66-70	42-44	1002+1000+1017	1004
100x70	96-100/66-70	45-47	1102+1000+1017	1061
110x70	104-109/66-70	47-49	1103+1000+1017	1094
120x70	116-122/66-70	49-51	1104+1000+1017	1117
130x70	124-129/66-70	57-59	1105+1000+1017	1149
140x70	134-139/66-70	57-59	1106+1000+1017	1208
Medidas	Rangos	Apertura	Referencias	Puntos
80x80	76-80/76-80	41-43	1001+1001+1017	1004
90x80	86-90/76-80	45-47	1002+1001+1017	1061
100x80	96-100/76-80	48-50	1102+1001+1017	1118
110x80	104-109/76-80	50-52	1103+1001+1017	1151
120x80	116-122/76-80	52-54	1104+1001+1017	1174
130x80	124-129/76-80	60-62	1105+1001+1017	1206
140x80	134-139/76-80	60-62	1106+1001+1017	1265
Medidas	Rangos	Apertura	Referencias	Puntos
90x90	86-90/86-90	48-50	1002+1002+1017	1118
100x90	96-100/86-90	51-53	1102+1002+1017	1175
110x90	104-109/86-90	53-55	1103+1002+1017	1208
120x90	116-122/86-90	55-57	1104+1002+1017	1231
130x90	124-129/86-90	63-65	1105+1002+1017	1263
140x90	134-139/86-90	63-65	1106+1002+1017	1322
Perfil de compensación +1 cm			1074	62

\*También se pueden combinar los frontales con medidas intermedias.

\*El rango aumenta 2 cm con respecto al formato frontal.



## MOVING frontal + lateral fijo



Descripción	Rango	Referencias	Puntos
Lateral fijo MOVING 70	67-69	1015	332
Lateral fijo MOVING 75	72-74	1100	338
Lateral fijo MOVING 80	77-79	1016	345
Lateral fijo MOVING 90	87-89	1018	363

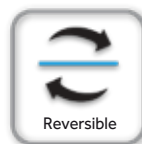
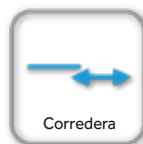

## combinaciones frontales MOVING + lateral fijo 8 mm

Medidas	Rangos	Referencias	Puntos	Medidas	Rangos	Referencias	Puntos
100X70	96-100/67-69	1003+1015	942	100X75	96-100/72-74	1003+1100	948
110X70	106-110/67-69	1004+1015	1005	110X75	106-110/72-74	1004+1100	1011
120X70	116-120/67-69	1005+1015	1029	120X75	116-120/72-74	1005+1100	1035
130X70	126-130/67-69	1006+1015	1088	130X75	126-130/72-74	1006+1100	1094
140X70	136-140/67-69	1007+1015	1130	140X75	136-140/72-74	1007+1100	1136
150X70	146-150/67-69	1008+1015	1165	150X75	146-150/72-74	1008+1100	1171
160X70	156-160/67-69	1009+1015	1192	160X75	156-160/72-74	1009+1100	1198
170X70	166-170/67-69	1010+1015	1219	170X75	166-170/72-74	1010+1100	1225
180X70	176-180/67-69	1011+1015	1268	180X75	176-180/72-74	1011+1100	1274
Medidas	Rangos	Referencias	Puntos	Medidas	Rangos	Referencias	Puntos
100X80	96-100/77-79	1003+1016	955	100X90	96-100/87-89	1003+1018	973
110X80	106-110/77-79	1004+1016	1018	110X90	106-110/87-89	1004+1018	1036
120X80	116-120/77-79	1005+1016	1042	120X90	116-120/87-89	1005+1018	1060
130X80	126-130/77-79	1006+1016	1101	130X90	126-130/87-89	1006+1018	1119
140X80	136-140/77-79	1007+1016	1143	140X90	136-140/87-89	1007+1018	1161
150X80	146-150/77-79	1008+1016	1178	150X90	146-150/87-89	1008+1018	1196
160X80	156-160/77-79	1009+1016	1205	160X90	156-160/87-89	1009+1018	1223
170X80	166-170/77-79	1010+1016	1232	170X90	166-170/87-89	1010+1018	1250
180X80	176-180/77-79	1011+1016	1281	180X90	176-180/87-89	1011+1018	1299
Perfil pared (+1cm)		1074	62				

\*Se pueden combinar los frontales con medidas intermedias.

\*El rango se reduce 2 cm con respecto al formato frontal.

\*La apertura es la misma que en los frontales.



### Laterales fijos a medida (más información en página 282)

Descripción	Referencias	Puntos	Cajonado
Lateral fijo a medida MOVING hasta 40 cm	1341	305	+21
Lateral fijo a medida MOVING de 40 hasta 80 cm	1301	390	+21
Lateral fijo a medida MOVING de 80 hasta 120 cm	1307	460	+21
Perfil de unión fijo + lateral fijo (ver pág. 285)	1075	82	

\*Plazo de entrega 15 días

# screen

## 8mm

"Sencillez y belleza con  
amplitud de opciones y  
colores"







# SCREEN

combinación con referencias 0160+0166



Descripción	TRANSPARENTE		FROST PLUS	
	Ref.	Puntos	Ref.	Puntos
Cristal fijo 68	0164	174	0174	196
Cristal fijo 78	0165	190	0175	211
Cristal fijo 88	0160	204	0170	228
Cristal fijo 98	0161	223	0171	248
Cristal fijo 108	0162	243	0172	268
Cristal fijo 118	0169	263	0179	288

\*Fijos a medida (ver página 283).

Descripción	Ref.	Puntos
Brazo soporte PARED recto ext. (55-100)	0166	37
Brazo soporte PARED 45° ext. (55-85)	0168	37
Brazo soporte CRISTAL-CRISTAL ext. (55-85)	0167	37
Brazo cuadrado PARED recto/45° ajust. (60-120)	0184	37

\*Otras opciones de brazo (ver página 167).

brazo 0166



brazo 0168



brazo 0167



brazo 0184





# SCREEN MOVING

combinación con referencias 0170+0194+0166



H195  
Altura

8mm  
Grosor cristal

Reversible

aluminio  
**AL**  
aluminium

Tratamiento anticorrosión  
clear shield glass

● Negro  
○ Blanco  
● Oro  
Colores

Descripción	TRANSPARENTE		FROST PLUS	
	Ref.	Puntos	Ref.	Puntos
Móvil 25 cm	0153	124	0193	140
Móvil 40 cm	0154	147	0194	162

Los cristales móviles aumentan 24,5 / 39,5 cm la medida del fijo

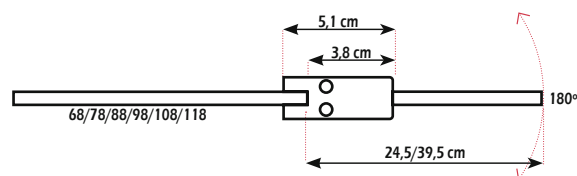

# SCREEN 35 BISAGRA 180°

combinación con referencias 0160+0331+0166



Bisagra latón cromado

Descripción	TRANSPARENTE		FROST PLUS	
	Ref.	Puntos	Ref.	Puntos
Abatible 35 cm	0331	165	0332	187

\*Abatibles a medida (ver página 283).

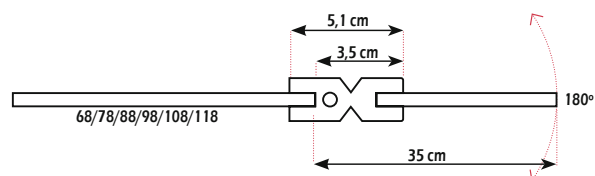

# SCREEN GOLD

Oro cepillado

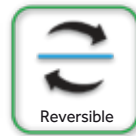

Descripción	TRANSPARENTE		FROST PLUS	
	Ref.	Puntos	Ref.	Puntos
Screen Gold de 68 cm + brazo soporte oro	SC70OR	261	SC70FOR	283
Screen Gold de 78 cm + brazo soporte oro	SC80OR	277	SC80FOR	298
Screen Gold de 88 cm + brazo soporte oro	SC90OR	291	SC90FOR	315
Screen Gold de 98 cm + brazo soporte oro	SC100OR	310	SC100FOR	335
Screen Gold de 108 cm + brazo soporte oro	SC110OR	330	SC110FOR	355
Screen Gold de 118 cm + brazo soporte oro	SC120OR	350	SC120FOR	375

\*Incluye brazo orientable/ajustable 60-120 cm.

## SCREEN GOLD a medida

Descripción	TRANSPARENTE		FROST PLUS	
	Ref.	Puntos	Ref.	Puntos
Ancho < 80 cm Altura hasta 195 cm	1305OR	296	1305OR+1313	418
Ancho de 80 a 120 cm Altura hasta 195 cm	1311OR	370	1311OR+1315	492

\*No incluye brazo ajustable 60-120 cm Screen Gold ref. 0187 / 45 Puntos  
Plazo de entrega 15 días

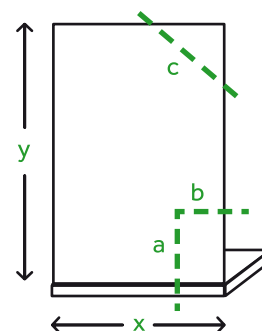

**CORTE ESCUADRA/CAJONADO  
PARA CRISTAL A MEDIDA**  
Ref.: 0862 | Puntos: 21

# SCREEN GOLD móvil bisagra 180°

Oro cepillado



SCREEN

	TRANSPARENTE		FROST PLUS	
Descripción	Ref.	Puntos	Ref.	Puntos
Cristal móvil de 35 cm	0331+0334	221	0332+0334	243

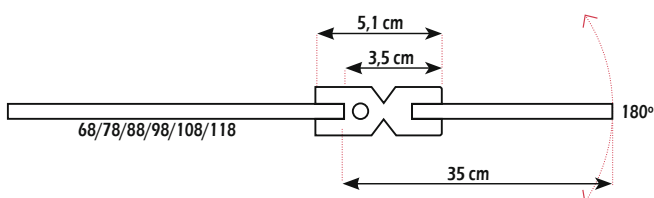

## SCREEN GOLD móvil bisagras 180° a medida

Móvil a medida	TRANSPARENTE		FROST PLUS	
Medida	Ref.	Puntos	Ref.	Puntos
hasta 40 cm	1355OR	261	1357OR	367
de 40 a 80 cm	1356OR	325	1358OR	465

Plazo de entrega 15 días

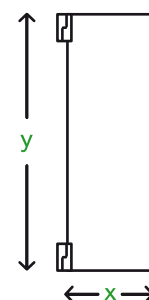

# SCREEN BLACK

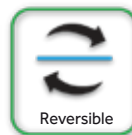

Descripción	TRANSPARENTE		FROST PLUS	
	Ref.	Puntos	Ref.	Puntos
Screen Black de 68 cm + brazo soporte negro	SC70N	231	SC70FN	261
Screen Black de 78 cm + brazo soporte negro	SC80N	247	SC80FN	276
Screen Black de 88 cm + brazo soporte negro	SC90N	261	SC90FN	293
Screen Black de 98 cm + brazo soporte negro	SC100N	280	SC100FN	313
Screen Black de 108 cm + brazo soporte negro	SC110N	300	SC110FN	333
Screen Black de 118 cm + brazo soporte negro	SC120N	320	SC120FN	353

\*Incluye brazo orientable/ajustable 60-120 cm. Opción barra paralela 9027, incremento 80 puntos.

## SCREEN BLACK a medida

Descripción	TRANSPARENTE		FROST PLUS	
	Ref.	Puntos	Ref.	Puntos
Ancho < 80 cm Altura hasta 195 cm	1305N	286	1305N+1313	408
Ancho de 80 a 120 cm Altura hasta 195 cm	1311N	360	1311N+1315	482

\*No incluye brazo ajustable 60-120 cm Screen Black ref. 0990 / 40 Puntos  
Plazo de entrega 15 días

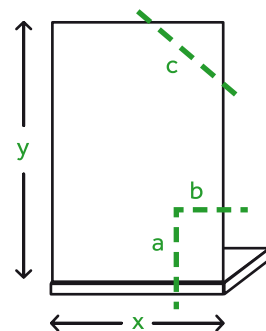

**CORTE ESCUADRA/CAJONADO  
PARA CRISTAL A MEDIDA**  
Ref.: 0862 | Puntos: 21

# SCREEN BLACK móvil bisagra 180°



Descripción	TRANSPARENTE		FROST PLUS	
	Ref.	Puntos	Ref.	Puntos
Cristal móvil de 35 cm	0331N	214	0332+9021	236

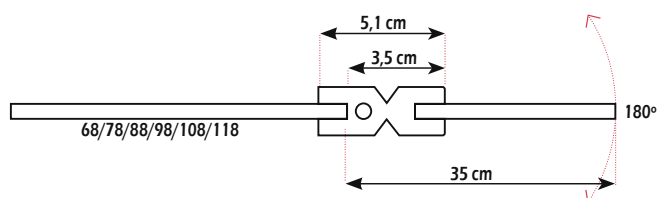

## SCREEN BLACK móvil bisagras 180° a medida

Móvil a medida	TRANSPARENTE		FROST PLUS	
	Ref.	Puntos	Ref.	Puntos
hasta 40 cm	1355N	241	1357N	347
de 40 a 80 cm	1356N	305	1358N	445

Plazo de entrega 15 días

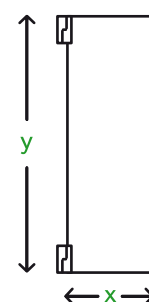

# SCREEN WHITE

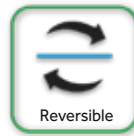

Medida	TRANSPARENTE		FROST PLUS	
	Ref.	Puntos	Ref.	Puntos
Screen White de 68 cm + brazo soporte blanco	SC70B	231	SC70FB	261
Screen White de 78 cm + brazo soporte blanco	SC80B	247	SC80FB	276
Screen White de 88 cm + brazo soporte blanco	SC90B	261	SC90FB	293
Screen White de 98 cm + brazo soporte blanco	SC100B	280	SC100FB	313
Screen White de 108 cm + brazo soporte blanco	SC110B	300	SC110FB	333
Screen White de 118 cm + brazo soporte blanco	SC120B	320	SC120FB	353

\*Incluye brazo orientable/ajustable 60-120 cm

## SCREEN WHITE a medida

Descripción	TRANSPARENTE		FROST PLUS	
	Ref.	Puntos	Ref.	Puntos
Ancho < 80 cm Altura hasta 195 cm	1305B	286	1305B+1313	408
Ancho de 80 a 120 cm Altura hasta 195 cm	1311B	360	1311B+1315	482

\*No incluye brazo ajustable 60-120 cm Screen White ref. 0186 / 40 Puntos  
Plazo de entrega 15 días

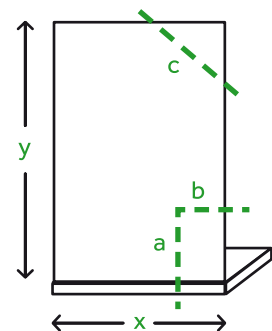

**CORTE ESCUADRA/CAJONADO  
PARA CRISTAL A MEDIDA**  
Ref.: 0862 | Puntos: 21



# SCREEN WHITE móvil bisagra 180°



SCREEN

	TRANSPARENTE		FROST PLUS	
Descripción	Ref.	Puntos	Ref.	Puntos
móvil de 35 cm	0331+0333	214	0332+0333	236

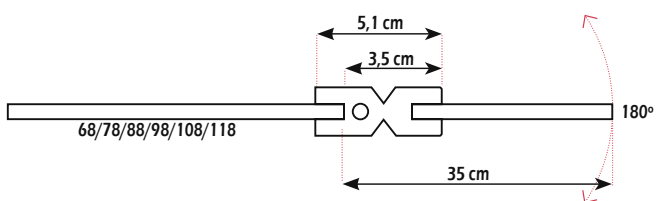

## SCREEN WHITE móvil bisagras 180° a medida

	TRANSPARENTE		FROST PLUS	
Descripción	Ref.	Puntos	Ref.	Puntos
hasta 40 cm	1355B	241	1357B	347
de 40 a 80 cm	1356B	305	1358B	445

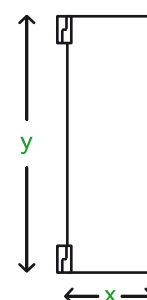

Plazo de entrega 15 días

# SCREEN BLACK CHESS



combinación con referencias 0983+0990



referencias 0983+0986+0990



Opción rodapie negro 2 m

Medida	Rango	Ref.	Puntos
Black Chess 70x195 + brazo soporte	67/69,5	0980+0990	280
Black Chess 80x195 + brazo soporte	77/79,5	0981+0990	302
Black Chess 90x195 + brazo soporte	87/89,5	0982+0990	320
Black Chess 100x195 + brazo soporte	97/99,5	0983+0990	342
Black Chess 110x195 + brazo soporte	107/109,5	0984+0990	365
Black Chess 120x195 + brazo soporte	117/119,5	0985+0990	400
Abatible de 35x195 cm, instalación derecha		0986	179
Abatible de 35x195 cm, instalación izquierda		0987	179



Ref.	Puntos
0993	25

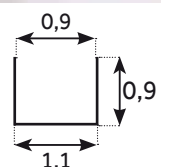

# SCREEN BLACK CHESS XXL

combinación con referencias 2x0980+0990+0992



Utiliza el nuevo perfil unión ref. 0992 para unir cualquiera de las referencias de fijos Screen Black Chess y conseguir medidas superiores a 120 cm.

Descripción	Ref.	Puntos
Perfil unión negro para 2 cristales fijos	0992	35

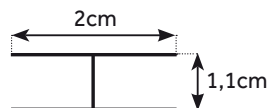

referencias 0980+0983+0991+0990



## BLACK CHESS ANGULAR

Descripción	Referencia	Puntos
Perfil negro en ángulo	0991	40

\*Aumenta 1,3 cm en uno de los lados

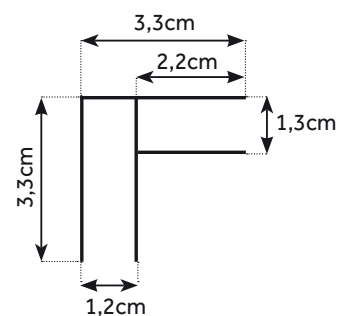

## Brazos para Screen, Open y Glass

barra con 1 soporte + soporte lateral fijo



soporte sujeción a pared



soporte sujeción a fijo



soporte sujeción a lateral fijo  
ref.1718

Descripción	Ref.	Puntos
Barra 140 con un soporte (para frontal)	1716	60
Barra 140 un soporte + soporte lateral fijo	1716+1718	76

barra con 2 soportes



Descripción	Ref.	Puntos
Barra 200 con dos soportes (para frontal)	1717	80
Barra 200 dos soportes + soporte lateral fijo	1717+1718	96



Descripción	Ref.	Puntos
Barra apertura al vértice GLASS/OPEN	1716x2+1730	135



Descripción	Ref.	Puntos
Colgador GME	0012	8



Descripción	Ref.	Puntos
Mastil a techo Screen	0188	62

Altura máxima 260 cm



Descripción	Ref.	Puntos
Brazo 60-120 cm cromo recto/45°	0184	37



Descripción	Ref.	Puntos
Brazo 60-120 cm negro recto/45°	0990	40



Descripción	Ref.	Puntos
Brazo 60-120 cm blanco recto/45°	0186	40



Descripción	Ref.	Puntos
Brazo 60-120 cm oro recto/45°	0187	45



Descripción	Ref.	Puntos
Barra 140 con soporte en negro	9026	60
Barra 200 con soporte en negro	9027	80



Descripción	Ref.	Puntos
Corner minimal 20x40 cm	1719	30

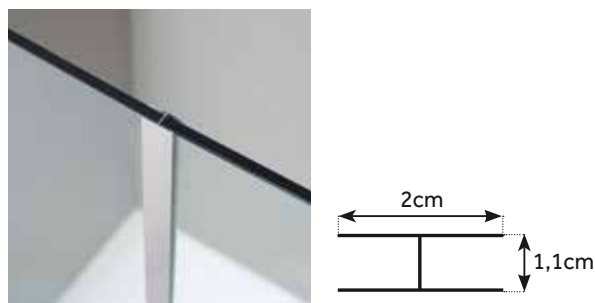

Descripción	Ref.	Puntos
Perfil unión para 2 fijos	0180	33
Perfil unión negro para 2 fijos	0992	35

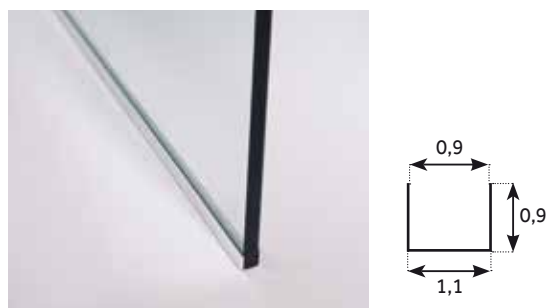

Descripción	Ref.	Puntos
Opción rodapie aluminio 2 m	0994	25
Opción rodapie negro 2 m	0993	25

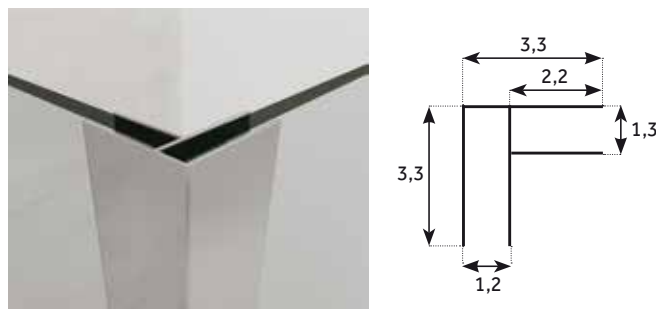

Descripción	Ref.	Puntos
Perfil en ángulo	0182	40
Perfil en ángulo negro	0991	40

\*Aumenta 1,3 cm en uno de los lados

# GME

OPEN pg.170



OPEN BLACK pg.204





GLASS pg.226



ABATIBLES

# MAMPARAS ABATIBLES

# open

"Programa modular de fijos  
y abatibles que se adaptan a  
cualquier espacio"





OPEN

# OPEN COMBI A puerta con cierre imán a pared



**COMBI A FREE**

\*Opción instalación formato free, rango -3cm

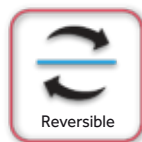

## COMBI A

Medida	Rango cm	Apertura	TRANSPARENTE		FROST PLUS	
			Referencias	Puntos	Referencias	Puntos
40	41,1-42,6	33	1216 + 1211	262	-	-
45	46,1-47,6	38	1217 + 1211	269	-	-
50	51,1-52,6	43	1207 + 1211	275	1284 + 1211	300
55	56,1-57,6	48	1218 + 1211	284	1285 + 1211	309
60	61,1-62,6	53	1219 + 1211	292	1286 + 1211	317
65	66,1-67,6	58	1208 + 1211	297	1287 + 1211	322
70	71,1-72,6	63	1209 + 1211	307	1288 + 1211	332
75	76,1-77,6	68	1220 + 1211	322	1289 + 1211	347
80	81,1-82,6	73	1210 + 1211	327	1290 + 1211	352
85	86,1-87,6	78	1223 + 1211	337	1291 + 1211	362

\*Permite unión con laterales fijos STD en el lado de la puerta usando Ref. 1222 (rango mínimo +1,8 cm), ver pág. 202.

Descripción	Ref.	Puntos	
Perfil expansor puerta (+1,5 a +3 cm)	1222	48	
Perfil de pared open	1211	25	
Perfil puerta (reduce hasta 1 cm el rango)	1215	29	
Juego gomas imán expansión +1,2 cm	1221	24	
Juego gomas apertura IN-OUT 180°	1213	38	

# OPEN COMBI A + lat. fijo



Opción barra 140 cm más soporte lateral fijo-Ref. 1716+1718  
Incremento 38 puntos (ya descontado brazo 1214)

Lat. fijos 6 mm	TRANSPARENTE		FROST PLUS		
	Rango cm	Ref.	Puntos	Ref.	Puntos
	66-69	1720	155	1292	227
	76-79	1721	166	1293	246
	86-89	1722	178	1294	266
	<b>Brazo Open</b>	<b>1214</b>	<b>38</b>		

Descripción	Referencias	Puntos
Perfil compensación +2 cm	0218	25
Perfil compensación +4 cm	0029	35
Perfil compensación +5,5 cm	0219	35

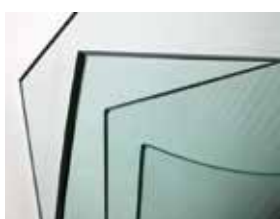

## Laterales fijos a medida 6 mm

Descripción	TRANSPARENTE		FROST PLUS		Cajonado
	Ref.	Puntos	Ref.	Puntos	
Lateral fijo a medida hasta 40 cm	1345	175	1345+1312	297	+21
Lateral fijo a medida de 40 hasta 80 cm	1316	250	1316+1313	372	+21
Lateral fijo a medida de 80 hasta 120 cm	1317	320	1317+1315	442	+21

\*Plazo de entrega 15 días. Más información ver pag. 282.





H195

Altura



6mm

Grosor cristal



Abatible 90°



1.5cm

Expansión

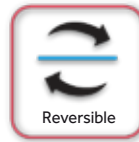

Reversible



aluminio  
AL  
aluminium



TRATAMIENTO  
ANTI-NEBLA  
clear  
shield  
glass



Negro

Ver pág. 205

Medidas	Rango	TRANSPARENTE		FROST PLUS	
		Referencia	Puntos	Referencia	Puntos
<b>COMBI A + LATERAL FIJO 70 c/BRAZO 1214</b>					
40X70	40,6-42,1/66-69	1216+1211+1720+1214	455	-	-
45X70	45,6-47,1/66-69	1217+1211+1720+1214	462	-	-
50X70	50,6-52,1/66-69	1207+1211+1720+1214	468	1284+1211+1292+1214	565
55X70	55,6-57,1/66-69	1218+1211+1720+1214	477	1285+1211+1292+1214	574
60X70	60,6-62,1/66-69	1219+1211+1720+1214	485	1286+1211+1292+1214	582
65X70	65,6-67,1/66-69	1208+1211+1720+1214	490	1287+1211+1292+1214	587
70X70	70,6-72,1/66-69	1209+1211+1720+1214	500	1288+1211+1292+1214	597
75X70	75,6-77,1/66-69	1220+1211+1720+1214	515	1289+1211+1292+1214	612
80X70	80,6-82,1/66-69	1210+1211+1720+1214	520	1290+1211+1292+1214	617
85X70	85,6-87,1/66-69	1223+1211+1720+1214	530	1291+1211+1292+1214	627
<b>COMBI A + LATERAL FIJO 80 c/BRAZO 1214</b>					
40X80	40,6-42,1/76-79	1216+1211+1721+1214	466	-	-
45X80	45,6-47,1/76-79	1217+1211+1721+1214	473	-	-
50X80	50,6-52,1/76-79	1207+1211+1721+1214	479	1284+1211+1293+1214	584
55X80	55,6-57,1/76-79	1218+1211+1721+1214	488	1285+1211+1293+1214	593
60X80	60,6-62,1/76-79	1219+1211+1721+1214	496	1286+1211+1293+1214	601
65X80	65,6-67,1/76-79	1208+1211+1721+1214	501	1287+1211+1293+1214	606
70X80	70,6-72,1/76-79	1209+1211+1721+1214	511	1288+1211+1293+1214	616
75X80	75,6-77,1/76-79	1220+1211+1721+1214	526	1289+1211+1293+1214	631
80X80	80,6-82,1/76-79	1210+1211+1721+1214	531	1290+1211+1293+1214	636
85X80	85,6-87,1/76-79	1223+1211+1721+1214	541	1291+1211+1293+1214	646
<b>COMBI A + LATERAL FIJO 90 c/BRAZO 1214</b>					
40X90	40,6-42,1/86-89	1216+1211+1722+1214	478	-	-
45X90	45,6-47,1/86-89	1217+1211+1722+1214	485	-	-
50X90	50,6-52,1/86-89	1207+1211+1722+1214	491	1284+1211+1294+1214	604
55X90	55,6-57,1/86-89	1218+1211+1722+1214	500	1285+1211+1294+1214	613
60X90	60,6-62,1/86-89	1219+1211+1722+1214	508	1286+1211+1294+1214	621
65X90	65,6-67,1/86-89	1208+1211+1722+1214	513	1287+1211+1294+1214	626
70X90	70,6-72,1/86-89	1209+1211+1722+1214	523	1288+1211+1294+1214	636
75X90	75,6-77,1/86-89	1220+1211+1722+1214	538	1289+1211+1294+1214	651
80X90	80,6-82,1/86-89	1210+1211+1722+1214	543	1290+1211+1294+1214	656
85X90	85,6-87,1/86-89	1223+1211+1722+1214	553	1291+1211+1294+1214	666

Las aperturas son las mismas que en los frontales.



Opción barra 140 cm más soporte lateral fijo-Ref. 1716+1718  
Incremento 38 puntos (ya descontado brazo 1214)

Apertura exterior  
90° p/fijo



Opción in-out  
0180° p/fijo



El rango del frontal aumenta 1,4 cm y el rango del lateral fijo se reduce 1 cm  
Ref. 0038 - Incremento 21 puntos

# OPEN COMBI B puerta con cierre perfil imán



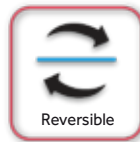

## COMBI B

Medida	Rango cm	Apertura	TRANSPARENTE		FROST PLUS	
			Referencias	Puntos	Referencias	Puntos
45	43,6-47,6	33	1216 + 1211 + 1212	332	-	-
50	48,6-52,6	38	1217 + 1211 + 1212	339	-	-
55	53,6-57,6	43	1207 + 1211 + 1212	345	1284 + 1211 + 1212	370
60	58,6-62,6	48	1218 + 1211 + 1212	354	1285 + 1211 + 1212	379
65	63,6-67,6	53	1219 + 1211 + 1212	362	1286 + 1211 + 1212	387
70	68,6-72,6	58	1208 + 1211 + 1212	367	1287 + 1211 + 1212	392
75	73,6-77,6	63	1209 + 1211 + 1212	377	1288 + 1211 + 1212	402
80	78,6-82,6	68	1220 + 1211 + 1212	392	1289 + 1211 + 1212	417
85	83,6-87,6	73	1210 + 1211 + 1212	397	1290 + 1211 + 1212	422
90	88,6-92,6	78	1223 + 1211 + 1212	407	1291 + 1211 + 1212	432

Permite unión con laterales fijos STD en lado perfil cierre imán (rango mínimo +0,7 cm, expansión +1,5 cm), ver pág. 202.

Permite unión con laterales fijos STD en lado puerta usando ref. 1222 (rango mínimo +1,8 cm, expansión +2,5 cm), ver pág. 202.

Descripción.	Ref	Puntos
Perfil compensación lado cierre perfil imán +3 cm	0218	25
Perfil compensación lado cierre perfil imán +6 cm	0029	35
Perfil cierre imán	1212	70
Perfil de pared open	1211	25
Perfil puerta (reduce hasta 1 cm el rango), ver pág. 285	1215	29
Juego gomas imán expansión +1,2 cm, ver pág. 285	1221	24
Perfil expansor lado puerta +2,5 cm, ver pág. 285	1222	48
Juego gomas apertura IN-OUT 180°	1213	38

# OPEN COMBI C fijo + puerta abatible con cierre imán a pared



Opción barra 140 cm Ref. 1716  
Incremento 60 puntos

FIJOS	TRANSPARENTE		FROST PLUS		
	Rango cm	Ref.	Puntos	Ref.	Puntos
	17,5-20	1200	120	-	-
	22,5-25	1201	128	-	-
	27,5-30	1202	136	1280	146
	37,5-40	1203	152	1281	162
	47,5-50	1204	168	1282	178
	57,5-60	1205	183	1283	193

(2,5 ajuste)



Paneles fijos a medida (ver pág. 281)

PUERTAS	TRANSPARENTE		FROST PLUS		
	Medida cm	Ref.	Puntos	Ref.	Puntos
	40	1216	237	-	-
	45	1217	244	-	-
	50	1207	250	1284	275
	55	1218	259	1285	284
	60	1219	267	1286	292
	65	1208	272	1287	297
	70	1209	282	1288	307
	75	1220	297	1289	322
	80	1210	302	1290	327
	85	1223	312	1291	337

(sin ajuste)

Ejemplo combinando 1200 + 1207, rango = 50 + (17,5-20) = 67,5-70 cm. Puntos 120 + 250 = 370  
 Suma rango mínimo fijo + medida de puerta / +2,5 cm ajuste

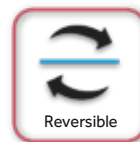

Combinación con puertas 50, 55, 65, 70, 80 y 85

## COMBI C

Medidas	Rango	Fijo	Puerta	Apertura
70	67,5-70	20	50	43
75	72,5-75	25	50	43
80	77,5-80	30	50	43
85	82,5-85	30	55	48
90	87,5-90	40	50	43
95	92,5-95	30	65	58
100	97,5-100	30	70	63
100	97,5-100	50	50	43
105	102,5-105	40	65	58
110	107,5-110	30	80	73
110	107,5-110	40	70	63
110	107,5-110	60	50	43
115	112,5-115	50	65	58
120	117,5-120	40	80	73
120	117,5-120	50	70	63
125	122,5-125	60	65	58
130	127,5-130	50	80	73
130	127,5-130	60	70	63
135	132,5-135	50	85	78
140	137,5-140	60	80	73
145	142,5-145	60	85	78

TRANSPARENTE		FROST PLUS	
Ref.	Puntos	Ref.	Puntos
1200+1207	370	-	-
1201+1207	378	-	-
1202+1207	386	1280+1284	421
1202+1218	395	1280+1285	430
1203+1207	402	1281+1284	437
1202+1208	408	1280+1287	443
1202+1209	418	1280+1288	453
1204+1207	418	1282+1284	453
1203+1208	424	1281+1287	459
1202+1210	438	1280+1290	473
1203+1209	434	1281+1288	469
1205+1207	433	1283+1284	468
1204+1208	440	1282+1287	475
1203+1210	454	1281+1290	489
1204+1209	450	1282+1288	485
1205+1208	455	1283+1287	490
1204+1210	470	1282+1290	505
1205+1209	465	1283+1288	500
1204+1223	480	1282+1291	515
1205+1210	485	1283+1290	520
1205+1223	495	1283+1291	530

\*Permite combinación con Lateral fijo STD en lado fijo, rango mínimo +0,7 (sin ajuste), ver pág. 202

\*Permite combinación con lateral fijo Glass en lado puerta, el rango del frontal se reduce 0,5 cm

Descripción	Ref.	Puntos
Perfil compensación +3 cm lado fijo	0218	25
Perfil compensación +6 cm lado fijo	0029	35
Juego gomas imán expansión +1,2 cm, ver pág. 285	1221	24
Juego gomas apertura IN-OUT 180°	1213	38



Opción barra 140 cm Ref. 1716. Incremento 60 puntos



\*Opción instalación formato free, rango -3cm

# OPEN COMBI C + lat. fijo



Opción barra 140 cm más soporte lateral fijo-Ref. 1716+1718  
Incremento 38 puntos (ya descontado brazo 1214)

## Laterales fijos 6 mm

Descripción	Rango	Ref.	Puntos
Lateral fijo 70x195	66-69	1720	155
Lateral fijo 80x195	76-79	1721	166
Lateral fijo 90x195	86-89	1722	178
<b>Brazo open</b>		<b>1214</b>	<b>38</b>

Descripción	Referencias	Puntos
Perfil compensación +2 cm	0218	25
Perfil compensación +4 cm	0029	35
Perfil compensación +5,5 cm	0219	35



## Laterales fijos TRANSPARENTES a medida 6 mm (más información en página 282)

Descripción	Ref.	Puntos	Cajonado
Lateral fijo a medida OPEN hasta 40 cm	1345	175	+21
Lateral fijo a medida OPEN de 40 hasta 80 cm	1316	250	+21
Lateral fijo a medida OPEN de 80 hasta 120 cm	1317	320	+21

\*Plazo de entrega 15 días.



## COMBI C + LATERAL FIJO 70 c/BRAZO 1214

Medidas (F+A) xLF	Rango	Referencia	Puntos
70 (20+50) x70	67-69,5/66-69	1200+1207+1720+1214	563
75 (25+50) x70	72-74,5/66-69	1201+1207+1720+1214	571
80 (30+50) x70	77-79,5/66-69	1202+1207+1720+1214	579
85 (20+65) x70	82-84,5/66-69	1200+1208+1720+1214	585
90 (20+70) x70	87-89,5/66-69	1200+1209+1720+1214	595
90 (25+65) x70	87-89,5/66-69	1201+1208+1720+1214	593
90 (40+50) x70	87-89,5/66-69	1203+1207+1720+1214	595
95 (25+70) x70	92-94,5/66-69	1201+1209+1720+1214	603
95 (30+65) x70	92-94,5/66-69	1202+1208+1720+1214	601
100 (20+80) x70	97-99,5/66-69	1200+1210+1720+1214	615
100 (30+70) x70	97-99,5/66-69	1202+1209+1720+1214	611
100 (50+50) x70	97-99,5/66-69	1204+1207+1720+1214	611
105 (25+80) x70	102-104,5/66-69	1201+1210+1720+1214	623
105 (40+65) x70	102-104,5/66-69	1203+1208+1720+1214	617
110 (30+80) x70	107-109,5/66-69	1202+1210+1720+1214	631
110 (40+70) x70	107-109,5/66-69	1203+1209+1720+1214	627
110 (60+50) x70	107-109,5/66-69	1205+1207+1720+1214	626
115 (50+65) x70	112-114,5/66-69	1204+1208+1720+1214	633
120 (40+80) x70	117-119,5/66-69	1203+1210+1720+1214	647
120 (50+70) x70	117-119,5/66-69	1204+1209+1720+1214	643
125 (60+65) x70	122-124,5/66-69	1205+1208+1720+1214	648
130 (50+80) x70	127-129,5/66-69	1204+1210+1720+1214	663
130 (60+70) x70	127-129,5/66-69	1205+1209+1720+1214	658
140 (60+80) x70	137-139,5/66-69	1205+1210+1720+1214	678
145 (60+85) x70	142-144,5/66-69	1205+1223+1720+1214	688

## COMBI C + LATERAL FIJO 80 c/BRAZO 1214

Medidas (F+A) xLF	Rango	Referencia	Puntos
70 (20+50) x80	67-69,5/76-79	1200+1207+1721+1214	574
75 (25+50) x80	72-74,5/76-79	1201+1207+1721+1214	582
80 (30+50) x80	77-79,5/76-79	1202+1207+1721+1214	590
85 (20+65) x80	82-84,5/76-79	1200+1208+1721+1214	596
90 (20+70) x80	87-89,5/76-79	1200+1209+1721+1214	606
90 (25+65) x80	87-89,5/76-79	1201+1208+1721+1214	604
90 (40+50) x80	87-89,5/76-79	1203+1207+1721+1214	606
95 (25+70) x80	92-94,5/76-79	1201+1209+1721+1214	614
95 (30+65) x80	92-94,5/76-79	1202+1208+1721+1214	612
100 (20+80) x80	97-99,5/76-79	1200+1210+1721+1214	626
100 (30+70) x80	97-99,5/76-79	1202+1209+1721+1214	622
100 (50+50) x80	97-99,5/76-79	1204+1207+1721+1214	622
105 (25+80) x80	102-104,5/76-79	1201+1210+1721+1214	634
105 (40+65) x80	102-104,5/76-79	1203+1208+1721+1214	628
110 (30+80) x80	107-109,5/76-79	1202+1210+1721+1214	642
110 (40+70) x80	107-109,5/76-79	1203+1209+1721+1214	638
110 (60+50) x80	107-109,5/76-79	1205+1207+1721+1214	637
115 (50+65) x80	112-114,5/76-79	1204+1208+1721+1214	644
120 (40+80) x80	117-119,5/76-79	1203+1210+1721+1214	658
120 (50+70) x80	117-119,5/76-79	1204+1209+1721+1214	654
125 (60+65) x80	122-124,5/76-79	1205+1208+1721+1214	659
130 (50+80) x80	127-129,5/76-79	1204+1210+1721+1214	674
130 (60+70) x80	127-129,5/76-79	1205+1209+1721+1214	669
140 (60+80) x80	137-139,5/76-79	1205+1210+1721+1214	689
145 (60+85) x80	142-144,5/76-79	1205+1223+1721+1214	699

Apertura exterior  
90° p/fijo



Opción in-out  
0180° p/fijo



El rango del frontal aumenta 1,4 cm y el rango del lateral fijo se reduce 1 cm  
Ref. 0038 - Incremento 21 puntos



Opción barra 140 cm más soporte lateral fijo-Ref. 1716+1718  
Incremento 38 puntos (ya descontado brazo 1214)

## COMBI C + LATERAL FIJO 90 c/BRAZO 1214

Medidas (F+A) xLF	Rango	Referencia	Puntos
70 (20+50) x90	67-69,5/86-89	1200+1207+1722+1214	586
75 (25+50) x90	72-74,5/86-89	1201+1207+1722+1214	594
80 (30+50) x90	77-79,5/86-89	1202+1207+1722+1214	602
85 (20+65) x90	82-84,5/86-89	1200+1208+1722+1214	608
90 (20+70) x90	87-89,5/86-89	1200+1209+1722+1214	618
90 (25+65) x90	87-89,5/86-89	1201+1208+1722+1214	616
90 (40+50) x90	87-89,5/86-89	1203+1207+1722+1214	618
95 (25+70) x90	92-94,5/86-89	1201+1209+1722+1214	626
95 (30+65) x90	92-94,5/86-89	1202+1208+1722+1214	624
100 (20+80) x90	97-99,5/86-89	1200+1210+1722+1214	638
100 (30+70) x90	97-99,5/86-89	1202+1209+1722+1214	634
100 (50+50) x90	97-99,5/86-89	1204+1207+1722+1214	634
105 (25+80) x90	102-104,5/86-89	1201+1210+1722+1214	646
105 (40+65) x90	102-104,5/86-89	1203+1208+1722+1214	640
110 (30+80) x90	107-109,5/86-89	1202+1210+1722+1214	654
110 (40+70) x90	107-109,5/86-89	1203+1209+1722+1214	650
110 (60+50) x90	107-109,5/86-89	1205+1207+1722+1214	649
115 (50+65) x90	112-114,5/86-89	1204+1208+1722+1214	656
120 (40+80) x90	117-119,5/86-89	1203+1210+1722+1214	670
120 (50+70) x90	117-119,5/86-89	1204+1209+1722+1214	666
125 (60+65) x90	122-124,5/86-89	1205+1208+1722+1214	671
130 (50+80) x90	127-129,5/86-89	1204+1210+1722+1214	686
130 (60+70) x90	127-129,5/86-89	1205+1209+1722+1214	681
140 (60+80) x90	137-139,5/86-89	1205+1210+1722+1214	701
145 (60+85) x90	142-144,5/86-89	1205+1223+1722+1214	711

# OPEN FROST PLUS COMBI C + lat. fijo



## laterales fijos FROST PLUS 6 mm

Descripción	Rango	Ref.	Puntos
Lateral fijo frost plus 70x195	66-69	1292	227
Lateral fijo frost plus 80x195	76-79	1293	246
Lateral fijo frost plus 90x195	86-89	1294	266
<b>Brazo open</b>		<b>1214</b>	<b>38</b>

Descripción	Referencias	Puntos
Perfil compensación +2 cm	0218	25
Perfil compensación +4 cm	0029	35
Perfil compensación +5,5 cm	0219	35

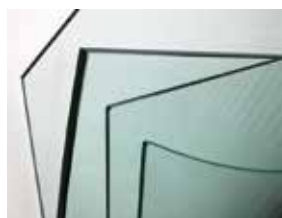

## Laterales fijos FROST PLUS a medida 6 mm (más información en página 282)

Descripción	Ref.	Puntos	Cajonado
Lateral fijo a medida OPEN hasta 40 cm	1345+1312	297	+21
Lateral fijo a medida OPEN de 40 hasta 80 cm	1316+1313	372	+21
Lateral fijo a medida OPEN de 80 hasta 120 cm	1317+1315	442	+21

\*Plazo de entrega 15 días.



H195

Altura



6mm

Grosor cristal



Abatible 90°



Opción 180°



1.5 cm

Expansión



Reversible



aluminio  
AL  
aluminium



tratamiento antical  
clear shield glass

### COMBI C + LATERAL FIJO 70 c/BRAZO 1214

Medidas (F+A) xLF	Rango	Referencia	Puntos
80 (30+50) x70	77-79,5/66-69	1280+1284+1292+1214	686
85 (30+55) x70	82-84,5/66-69	1280+1285+1292+1214	695
90 (40+50) x70	87-89,5/66-69	1281+1284+1292+1214	702
95 (30+65) x70	92-94,5/66-69	1280+1287+1292+1214	708
100 (30+70) x70	97-99,5/66-69	1280+1288+1292+1214	718
100 (50+50) x70	97-99,5/66-69	1282+1284+1292+1214	718
105 (40+65) x70	102-104,5/66-69	1281+1287+1292+1214	724
110 (30+80) x70	107-109,5/66-69	1280+1290+1292+1214	738
110 (40+70) x70	107-109,5/66-69	1281+1288+1292+1214	734
110 (60+50) x70	107-109,5/66-69	1283+1284+1292+1214	733
115 (50+65) x70	112-114,5/66-69	1282+1287+1292+1214	740
120 (40+80) x70	117-119,5/66-69	1281+1290+1292+1214	754
120 (50+70) x70	117-119,5/66-69	1282+1288+1292+1214	750
125 (60+65) x70	122-124,5/66-69	1283+1287+1292+1214	755
130 (50+80) x70	127-129,5/66-69	1282+1290+1292+1214	770
130 (60+70) x70	127-129,5/66-69	1283+1288+1292+1214	765
135 (50+85) x70	132-134,5/66-69	1282+1291+1292+1214	780
140 (60+80) x70	137-139,5/66-69	1283+1290+1292+1214	785
145 (60+85) x70	142-144,5/66-69	1283+1291+1292+1214	795

Apertura exterior 90° p/fijo



Opción in-out 0180° p/fijo



El rango del frontal aumenta 1,4 cm y el rango del lateral fijo se reduce 1 cm Ref. 0038 - Incremento 21 puntos



Opción barra 140 cm más soporte lateral fijo-Ref. 1716+1718 Incremento 38 puntos (ya descontado brazo 1214)

### COMBI C + LATERAL FIJO 80 c/BRAZO 1214

Medidas (F+A) xLF	Rango	Referencia	Puntos
80 (30+50) x80	77-79,5/76-79	1280+1284+1293+1214	705
85 (30+55) x80	82-84,5/76-79	1280+1285+1293+1214	714
90 (40+50) x80	87-89,5/76-79	1281+1284+1293+1214	721
95 (30+65) x80	92-94,5/76-79	1280+1287+1293+1214	727
100 (30+70) x80	97-99,5/76-79	1280+1288+1293+1214	737
100 (50+50) x80	97-99,5/76-79	1282+1284+1293+1214	737
105 (40+65) x80	102-104,5/76-79	1281+1287+1293+1214	743
110 (30+80) x80	107-109,5/76-79	1280+1290+1293+1214	757
110 (40+70) x80	107-109,5/76-79	1281+1288+1293+1214	753
110 (60+50) x80	107-109,5/76-79	1283+1284+1293+1214	752
115 (50+65) x80	112-114,5/76-79	1282+1287+1293+1214	759
120 (40+80) x80	117-119,5/76-79	1281+1290+1293+1214	773
120 (50+70) x80	117-119,5/76-79	1282+1288+1293+1214	769
125 (60+65) x80	122-124,5/76-79	1283+1287+1293+1214	774
130 (50+80) x80	127-129,5/76-79	1282+1290+1293+1214	789
130 (60+70) x80	127-129,5/76-79	1283+1288+1293+1214	784
135 (50+85) x80	132-134,5/76-79	1282+1291+1293+1214	799
140 (60+80) x80	137-139,5/76-79	1283+1290+1293+1214	804
145 (60+85) x80	142-144,5/76-79	1283+1291+1293+1214	814

### COMBI C + LATERAL FIJO 90 c/BRAZO 1214

Medidas (F+A) xLF	Rango	Referencia	Puntos
80 (30+50) x90	77-79,5/86-89	1280+1284+1294+1214	725
85 (30+55) x90	82-84,5/86-89	1280+1285+1294+1214	734
90 (40+50) x90	87-89,5/86-89	1281+1284+1294+1214	741
95 (30+65) x90	92-94,5/86-89	1280+1287+1294+1214	747
100 (30+70) x90	97-99,5/86-89	1280+1288+1294+1214	757
100 (50+50) x90	97-99,5/86-89	1282+1284+1294+1214	757
105 (40+65) x90	102-104,5/86-89	1281+1287+1294+1214	763
110 (30+80) x90	107-109,5/86-89	1280+1290+1294+1214	777
110 (40+70) x90	107-109,5/86-89	1281+1288+1294+1214	773
110 (60+50) x90	107-109,5/86-89	1283+1284+1294+1214	772
115 (50+65) x90	112-114,5/86-89	1282+1287+1294+1214	779
120 (40+80) x90	117-119,5/86-89	1281+1290+1294+1214	793
120 (50+70) x90	117-119,5/86-89	1282+1288+1294+1214	789
125 (60+65) x90	122-124,5/86-89	1283+1287+1294+1214	794
130 (50+80) x90	127-129,5/86-89	1282+1290+1294+1214	809
130 (60+70) x90	127-129,5/86-89	1283+1288+1294+1214	804
135 (50+85) x90	132-134,5/86-89	1282+1291+1294+1214	819
140 (60+80) x90	137-139,5/86-89	1283+1290+1294+1214	824
145 (60+85) x90	142-144,5/86-89	1283+1291+1294+1214	834

# OPEN COMBI D fijo+ puerta abatible con cierre imán



Opción barra 140 cm más soporte - Ref. 1716  
Incremento 60 puntos

FIJOS	TRANSPARENTE		FROST PLUS		
	Rango cm	Ref.	Puntos	Ref.	Puntos
	17,5/20	1200	120	-	-
	22,5/25	1201	128	-	-
	27,5/30	1202	136	1280	146
	37,5/40	1203	152	1281	162
	47,5/50	1204	168	1282	178
	57,5/60	1205	183	1283	193

(2,5 ajuste)

Cierre perfil imán ref.1212	62
-----------------------------	----



Paneles fijos a medida (ver pág. 281)

PUERTAS	TRANSPARENTE		FROST PLUS		
	Rango cm	Ref.	Puntos	Ref.	Puntos
	42,5/45	1216+1212	307	-	-
	47,5/50	1217+1212	314	-	-
	52,5/55	1207+1212	320	1284+1212	345
	57,5/60	1218+1212	329	1285+1212	354
	62,5/65	1219+1212	337	1286+1212	362
	67,5/70	1208+1212	342	1287+1212	367
	72,5/75	1209+1212	352	1288+1212	377
	77,5/80	1220+1212	367	1289+1212	392
	82,5/85	1210+1212	372	1290+1212	397
	87,5/90	1223+1212	382	1291+1212	407

(2,5 ajuste)

Ejemplo combinando 1200 + 1207 + 1212 = 17,5 + 52,5 + 5 cm de ajuste = 70-75 cm. Puntos 120 + 320 = 440  
Sume rango mínimo fijo + rango mínimo de puerta + 5 cm de ajuste

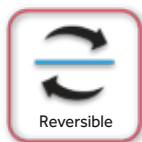

Combinación con puertas 50, 55, 65, 70, 80 y 85

## COMBI D

Medidas	Rango	Fijo	Puerta	Apert.
70	70-75	20	50	43
75	75-80	25	50	43
80	80-85	30	50	43
85	85-90	30	55	48
90	90-95	40	50	43
95	95-100	30	65	58
100	100-105	30	70	63
100	100-105	50	50	43
105	105-110	40	65	58
110	110-115	30	80	73
110	110-115	40	70	63
110	110-115	60	50	43
115	115-120	50	65	58
120	120-125	40	80	73
120	120-125	50	70	63
125	125-130	60	65	58
130	130-135	50	80	73
130	130-135	60	70	63
135	135-140	50	85	78
140	140-145	60	80	73
145	145-150	60	85	78

TRANSPARENTE	
Referencia	Puntos
1200+1207+1212	440
1201+1207+1212	448
1202+1207+1212	456
1202+1218+1212	465
1203+1207+1212	472
1202+1208+1212	478
1202+1209+1212	488
1204+1207+1212	488
1203+1208+1212	494
1202+1210+1212	508
1203+1209+1212	504
1205+1207+1212	503
1204+1208+1212	510
1203+1210+1212	524
1204+1209+1212	520
1205+1208+1212	525
1204+1210+1212	540
1205+1209+1212	535
1204+1223+1212	550
1205+1210+1212	555
1205+1223+1212	565

FROST PLUS	
Referencia	Puntos
-	-
-	-
1280+1284+1212	491
1280+1285+1212	500
1281+1284+1212	507
1280+1287+1212	513
1280+1288+1212	523
1282+1284+1212	523
1281+1287+1212	529
1280+1290+1212	543
1281+1288+1212	539
1283+1284+1212	538
1282+1287+1212	545
1281+1290+1212	559
1282+1288+1212	555
1283+1287+1212	560
1282+1290+1212	575
1283+1288+1212	570
1282+1291+1212	585
1283+1290+1212	590
1283+1291+1212	600

\*Permite uso perfil compensación en ambos lados

\*Permite combinación con Lateral fijo STD, rango mínimo +0,7 / expansión 2,5 cm (ver pág. 202)

Descripción	Ref.	Puntos
Perfil compensación lado fijo +3 cm	0218	25
Perfil compensación lado fijo +6 cm	0029	35
Juego gomas imán expansión +1,2 cm, ver pág. 285	1221	24
Juego gomas apertura IN-OUT 180°	1213	38



Opción barra 140 cm Ref. 1716. Incremento 60 puntos



# OPEN COMBI E + puerta abatible con cierre a fijo



Opción barra 140 más soporte Ref. 1716  
Incremento 60 puntos

## COMBI E

FIJOS	Rango cm	Ref.	Puntos
FIJO 20	17,5/20	1200	120
FIJO 25	22,5/25	1201	128
FIJO 30	27,5/30	1202	136
FIJO 40	37,5/40	1203	152
FIJO 50	47,5/50	1204	168
FIJO 60	57,5/60	1205	183
(2,5 ajuste)			
Perfil pared ref. 1211			25



Paneles fijos a medida (ver pág. 281)

PUERTAS	Rango cm	Ref.	Puntos
PUERTA 40	41,1/42,6	1216 + 1211	262
PUERTA 45	46,1/47,6	1217 + 1211	269
PUERTA 50	51,1/52,6	1207 + 1211	275
PUERTA 55	56,1/57,6	1218 + 1211	284
PUERTA 60	61,1/62,6	1219 + 1211	292
PUERTA 65	66,1/67,6	1208 + 1211	297
PUERTA 70	71,1/72,6	1209 + 1211	307
PUERTA 75	76,1/77,6	1220 + 1211	322
PUERTA 80	81,1/82,6	1210 + 1211	327
PUERTA 85	86,1/87,6	1223 + 1211	337

(1,5 ajuste)

Ejemplo combinando 1200 + 1207 + 1211 = 17,5 + 51,1 + 4 cm de ajuste = 68,6-72,6 cm. Puntos 120 + 275 = 395  
Rango = rango mínimo del fijo + rango mínimo de la puerta + 4 cm de ajuste



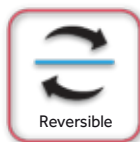

## COMBI E

Combinación con puertas 50, 65, 70 y 80

Medidas	Rango	Fijo	Puerta	Apertura	Referencia	Puntos
70	68,6-72,6	20	50	43	1200+1207+1211	403
75	73,6-77,6	25	50	43	1201+1207+1211	411
80	78,6-82,6	30	50	43	1202+1207+1211	417
85	83,6-87,6	20	65	58	1200+1208+1211	420
90	88,6-92,6	40	50	43	1203+1207+1211	427
90	88,6-92,6	25	65	58	1201+1208+1211	425
90	88,6-92,6	20	70	63	1200+1209+1211	427
95	93,6-97,6	25	70	63	1201+1209+1211	435
95	93,6-97,6	30	65	58	1202+1208+1211	433
100	98,6-102,6	30	70	63	1202+1209+1211	447
100	98,6-102,6	20	80	73	1200+1210+1211	443
100	98,6-102,6	50	50	43	1204+1207+1211	443
105	103,6-107,6	25	80	73	1201+1210+1211	455
105	103,6-107,6	40	65	58	1203+1208+1211	449
110	108,6-112,6	30	80	73	1202+1210+1211	463
110	108,6-112,6	40	70	63	1203+1209+1211	459
110	108,6-112,6	60	50	43	1205+1207+1211	458
115	113,6-117,6	50	65	58	1204+1208+1211	465
120	118,6-122,6	40	80	73	1203+1210+1211	479
120	118,6-122,6	50	70	63	1204+1209+1211	475
125	123,6-127,6	60	65	58	1205+1208+1211	480
130	128,6-132,6	50	80	73	1204+1210+1211	495
130	128,6-132,6	60	70	63	1205+1209+1211	490
135	133,6-137,6	50	85	78	1204+1223+1211	505
140	138,6-142,6	60	80	73	1205+1210+1211	510
145	143,6-147,6	60	85	78	1205+1223+1211	520

\*Permite combinación con Lateral fijo STD en lado fijo, rango mínimo +0,7 / expansión 1,5 cm (ver pág. 202)

\*Permite unión con Lateral fijo STD en lado puerta usando ref. 1222, rango mínimo +1,8 cm / ajuste 2,5 cm (ver pág. 202)

Descripción	Ref	Puntos
Perfil compensación lado fijo +3 cm	0218	25
Perfil compensación lado fijo +6 cm	0029	35
Perfil puerta (reduce hasta 1 cm el rango), ver pág. 285	1215	29
Juego gomas imán expansión +1,2 cm, ver pág. 285	1221	24
Perfil expansor puerta +2,5 cm, ver pág. 285	1222	48
Juego gomas apertura IN-OUT 180°	1213	38



Opción barra 140 cm ref. 1716. Incremento 60 puntos

# OPEN COMBI F fijo + puerta abatible + fijo



Opción barra 140 cm, ref. 1716 + 60 puntos  
Opción barra 200 cm, ref. 1717 + 80 puntos

## COMBI F

FIJOS	Rango cm	Ref.	Puntos	PUERTAS	Medida cm	Ref.	Puntos
FIJO 20	17,5/20	1200	120	PUERTA 40	40	1216	237
FIJO 25	22,5/25	1201	128	PUERTA 45	45	1217	244
FIJO 30	27,5/30	1202	136	PUERTA 50	50	1207	250
FIJO 40	37,5/40	1203	152	PUERTA 55	55	1218	259
FIJO 50	47,5/50	1204	168	PUERTA 60	60	1219	267
FIJO 60	57,5/60	1205	183	PUERTA 65	65	1208	272
(ajuste 2,5x2 = 5cm)				PUERTA 70	70	1209	282
 Paneles fijos a medida (ver pág. 281)				PUERTA 75	75	1220	297
				PUERTA 80	80	1210	302
				PUERTA 85	85	1223	312



Ejemplo combinando 1200+1207+1200= 17,5+50+17,5 +5cm de ajuste = 85-90. Puntos 120+250+120= 490  
sume rango mínimo de los fijos + rango mínimo de la puerta +5 cm de ajuste

## COMBI F Combinación puertas 50, 65, 70 y 80

Medidas (F+P+F)	Referencia	Ap.	Rango	Puntos
90 (20+50+20)	1200+1207+1200	43	85-90	490
95 (20+50+25)	1200+1207+1201	43	90-95	498
100 (25+50+25)	1201+1207+1201	43	95-100	506
100 (20+50+30)	1200+1207+1202	43	95-100	506
105 (25+50+30)	1201+1207+1202	43	100-105	514
105 (20+65+20)	1200+1208+1200	58	100-105	512
110 (20+65+25)	1200+1208+1201	58	105-110	520
110 (20+70+20)	1200+1209+1200	63	105-110	522
110 (30+50+30)	1202+1207+1202	43	105-110	522
115 (20+65+30)	1200+1208+1202	58	110-115	528
115 (20+70+25)	1200+1209+1201	63	110-115	530
120 (30+50+40)	1202+1207+1203	43	115-120	538
120 (25+65+30)	1201+1208+1202	58	115-120	536
120 (20+70+30)	1200+1209+1202	63	115-120	538
120 (20+80+20)	1200+1210+1200	73	115-120	542
125 (20+65+40)	1200+1208+1203	58	120-125	544
125 (30+65+30)	1202+1208+1202	58	120-125	544
125 (25+70+30)	1201+1209+1202	63	120-125	546
125 (25+80+20)	1201+1210+1200	73	120-125	550
130 (25+65+40)	1201+1208+1203	58	125-130	552
130 (20+70+40)	1200+1209+1203	63	125-130	554
130 (30+70+30)	1202+1209+1202	63	125-130	554
130 (20+80+30)	1200+1210+1202	73	125-130	558
130 (20+50+60)	1200+1207+1205	43	125-130	553
135 (20+65+50)	1200+1208+1204	58	130-135	560
135 (30+65+40)	1202+1208+1203	58	130-135	560
135 (25+70+40)	1201+1209+1203	63	130-135	562
135 (25+80+30)	1201+1210+1202	73	130-135	566
135 (25+50+60)	1201+1207+1205	43	130-135	561
140 (25+65+50)	1201+1208+1204	58	135-140	568
140 (20+70+50)	1200+1209+1204	63	135-140	570
140 (30+70+40)	1202+1209+1203	63	135-140	570
140 (20+80+40)	1200+1210+1203	73	135-140	574
140 (30+80+30)	1202+1210+1202	73	135-140	574
140 (30+50+60)	1202+1207+1205	43	135-140	569
145 (30+65+50)	1202+1208+1204	58	140-145	576
145 (40+65+40)	1203+1208+1203	58	140-145	576

## COMBI F Combinación puertas 50, 65, 70 y 80

Medidas (F+P+F)	Referencia	Ap.	Rango	Puntos
145 (25+70+50)	1201+1209+1204	63	140-145	578
145 (25+80+40)	1201+1210+1203	73	140-145	582
145 (20+65+60)	1200+1208+1205	58	140-145	575
150 (40+50+60)	1203+1207+1205	43	145-150	585
150 (25+65+60)	1201+1208+1205	58	145-150	583
150 (20+70+60)	1200+1209+1205	63	145-150	585
150 (30+70+50)	1202+1209+1204	63	145-150	586
150 (40+70+40)	1203+1209+1203	63	145-150	586
150 (30+80+40)	1202+1210+1203	73	145-150	590
150 (20+80+50)	1200+1210+1204	73	145-150	590
155 (30+65+60)	1202+1208+1205	58	150-155	591
155 (25+70+60)	1201+1209+1205	63	150-155	593
155 (40+65+50)	1203+1208+1204	58	150-155	592
155 (25+80+50)	1201+1210+1204	73	150-155	598
160 (50+50+60)	1204+1207+1205	43	155-160	601
160 (30+70+60)	1202+1209+1205	63	155-160	601
160 (40+70+50)	1203+1209+1204	63	155-160	602
160 (30+80+50)	1202+1210+1204	73	155-160	606
160 (20+80+60)	1200+1210+1205	73	155-160	605
160 (40+80+40)	1203+1210+1203	73	155-160	606
165 (40+65+60)	1203+1208+1205	58	160-165	607
165 (50+65+50)	1204+1208+1204	58	160-165	608
165 (25+80+60)	1201+1210+1205	73	160-165	613
170 (60+50+60)	1205+1207+1205	43	165-170	616
170 (40+70+60)	1203+1209+1205	63	165-170	617
170 (50+70+50)	1204+1209+1204	63	165-170	618
170 (30+80+60)	1202+1210+1205	73	165-170	621
170 (40+80+50)	1203+1210+1204	73	165-170	622
175 (50+65+60)	1204+1208+1205	58	170-175	623
180 (50+70+60)	1204+1209+1205	63	175-180	633
180 (40+80+60)	1203+1210+1205	73	175-180	637
180 (50+80+50)	1204+1210+1204	73	175-180	638
185 (60+65+60)	1205+1208+1205	58	180-185	638
190 (60+70+60)	1205+1209+1205	63	185-190	648
190 (50+80+60)	1204+1210+1205	73	185-190	653
200 (60+80+60)	1205+1210+1205	73	195-200	668

\*Permite unión con Lateral fijo STD en ambos lados (rango mínimo +0,7 cm / ajuste 2,5 cm), ver pág. 202.

\*Permite uso perfil compensación en ambos lados

Descripción	Ref.	Puntos
Perfil compensación lado fijo +3 cm	0218	25
Perfil compensación lado fijo +6 cm	0029	35
Juego gomas imán expansión +1,2 cm, ver pág. 285	1221	24
Juego gomas apertura IN-OUT 180°	1213	38

# OPEN COMBI G fijo + 2 puertas abatibles + fijo

● Negro  
Ver pág. 219



Opción barra 200 más soportes Ref. 1717  
Incremento 80 puntos

## FIJOS

Rango cm	TRANSPARENTE		FROST PLUS	
	Ref.	Puntos	Ref.	Puntos
17,5/20	1200	120	-	-
22,5/25	1201	128	-	-
27,5/30	1202	136	1280	146
37,5/40	1203	152	1281	162
47,5/50	1204	168	1282	178
57,5/60	1205	183	1283	193

(ajuste 2,5x2 = 5cm)



Paneles fijos a medida (ver pág. 281)

## PUERTAS

Medida cm	TRANSPARENTE		FROST PLUS	
	Ref.	Puntos	Ref.	Puntos
2 PUERTAS 76,2	1206	401	-	-
38,1	1216	237	-	-
43,1	1217	244	-	-
48,1	1207	250	1284	275
53,1	1218	259	1285	284
58,1	1219	267	1286	292
63,1	1208	272	1287	297
68,1	1209	282	1288	307
73,1	1220	297	1289	322
78,1	1210	302	1290	327
83,1	1223	312	1291	337

## COMBI G

Combinación con puertas 50, 65, 70 y 80

Medidas (F+P+P+F)	Rango	Referencia	Puntos
115 (20+40+40+20)	111,2-116,2	1200x2+1206	641
120 (20+40+40+25)	116,2-121,2	1200+1201+1206	649
125 (20+40+40+30)	121,2-126,2	1200+1202+1206	657
125 (25+40+40+25)	121,2-126,2	1201x2+1206	657
130 (25+40+40+30)	126,2-131,2	1201+1202+1206	665
135 (20+50+50+20)	131,2-136,2	1200x2+1207x2	740
135 (30+40+40+30)	131,2-136,2	1202x2+1206	673
140 (25+40+40+40)	136,2-141,2	1201+1203+1206	681
140 (20+50+50+25)	136,2-141,2	1200+1201+1207x2	748
145 (20+50+50+30)	141,2-146,2	1200+1202+1207x2	756
145 (30+40+40+40)	141,2-146,2	1202+1203+1206	689
150 (25+50+50+30)	146,2-151,2	1201+1202+1207x2	764
150 (25+40+40+50)	146,2-151,2	1201+1204+1206	697

## COMBI G

Combinación con puertas 50, 65, 70 y 80

Medidas (F+P+P+F)	Rango	Referencia	Puntos
155 (20+50+50+40)	151,2-156,2	1200+1203+1207x2	772
155 (30+50+50+30)	151,2-156,2	1202x2+1207x2	772
155 (40+40+40+40)	151,2-156,2	1203x2+1206	705
155 (20+40+40+60)	151,2-156,2	1200+1205+1206	704
160 (25+40+40+60)	156,2-161,2	1201+1205+1206	712
160 (25+50+50+40)	156,2-161,2	1201+1203+1207x2	780
165 (30+40+40+60)	161,2-166,2	1202+1205+1206	720
165 (30+50+50+40)	161,2-166,2	1202+1203+1207x2	788
165 (20+65+65+20)	161,2-166,2	1200x2+1208x2	784
165 (40+40+40+50)	161,2-166,2	1203+1204+1206	721
170 (20+65+65+25)	166,2-171,2	1200+1201+1208x2	792
175 (40+40+40+60)	171,2-176,2	1203+1205+1206	736
175 (30+50+50+50)	171,2-176,2	1202+1204+1207x2	804

## COMBI G

Combinación con puertas 50, 65, 70 y 80

Medidas (F+P+P+F)	Rango	Referencia	Puntos
175 (40+50+50+40)	171,2-176,2	1203x2+1207x2	804
175 (20+50+50+60)	171,2-176,2	1200+1205+1207x2	803
175 (20+65+65+30)	171,2-176,2	1200+1202+1208x2	800
175 (20+70+70+20)	171,2-176,2	1200x2+1209x2	804
175 (50+40+40+50)	171,2-176,2	1204x2+1206	737
180 (25+50+50+60)	176,2-181,2	1201+1205+1207x2	811
180 (25+65+65+30)	176,2-181,2	1201+1202+1208x2	808
180 (20+70+70+25)	176,2-181,2	1200+1201+1209x2	812
185 (50+40+40+60)	181,2-186,2	1204+1205+1206	752
185 (40+50+50+50)	181,2-186,2	1203+1204+1207x2	820
185 (30+50+50+60)	181,2-186,2	1202+1205+1207x2	819
185 (30+65+65+30)	181,2-186,2	1202x2+1208x2	816
185 (25+70+70+25)	181,2-186,2	1201x2+1209x2	820
185 (20+70+70+30)	181,2-186,2	1200+1202+1209x2	820
190 (25+65+65+40)	186,2-191,2	1201+1203+1208x2	824
190 (25+70+70+30)	186,2-191,2	1201+1202+1209x2	828
195 (60+40+40+60)	191,2-196,2	1205x2+1206	767
195 (50+50+50+50)	191,2-196,2	1204x2+1207x2	836
195 (40+50+50+60)	191,2-196,2	1203+1205+1207x2	835
195 (20+65+65+50)	191,2-196,2	1200+1204+1208x2	832
195 (30+65+65+40)	191,2-196,2	1202+1203+1208x2	832
195 (30+70+70+30)	191,2-196,2	1202x2+1209x2	836
195 (20+70+70+40)	191,2-196,2	1200+1203+1209x2	836
195 (20+80+80+20)	191,2-196,2	1200x2+1210x2	844
200 (25+65+65+50)	196,2-201,2	1201+1204+1208x2	840
200 (25+70+70+40)	196,2-201,2	1201+1203+1209x2	844
200 (25+80+80+20)	196,2-201,2	1201+1200+1210x2	852
205 (20+65+65+60)	201,2-206,2	1200+1205+1208x2	847
205 (40+65+65+40)	201,2-206,2	1203x2+1208x2	848
205 (30+65+65+50)	201,2-206,2	1202+1204+1208x2	848
205 (30+70+70+40)	201,2-206,2	1202+1203+1209x2	852
205 (20+70+70+50)	201,2-206,2	1200+1204+1209x2	852
205 (50+50+50+60)	201,2-206,2	1204+1205+1207x2	851
205 (20+80+80+30)	201,2-206,2	1200+1202+1210x2	860
210 (25+65+65+60)	206,2-211,2	1201+1205+1208x2	855
210 (25+70+70+50)	206,2-211,2	1201+1204+1209x2	860
210 (25+80+80+30)	206,2-211,2	1201+1202+1210x2	868

## COMBI G

Combinación con puertas 50, 65, 70 y 80

Medidas (F+P+P+F)	Rango	Referencia	Puntos
215 (30+65+65+60)	211,2-216,2	1202+1205+1208x2	863
215 (40+65+65+50)	211,2-216,2	1203+1204+1208x2	864
215 (20+70+70+60)	211,2-216,2	1200+1205+1209x2	867
215 (30+70+70+50)	211,2-216,2	1202+1204+1209x2	868
215 (40+70+70+40)	211,2-216,2	1203x2+1209x2	868
215 (30+80+80+30)	211,2-216,2	1202x2+1210x2	876
215 (20+80+80+40)	211,2-216,2	1200+1203+1210x2	876
215 (25+70+70+60)	216,2-221,2	1201+1205+1209x2	875
215 (60+50+50+60)	211,2-216,2	1205x2+1207x2	866
220 (25+80+80+40)	216,2-221,2	1201+1203+1210x2	884
225 (50+65+65+50)	221,2-226,2	1204x2+1208x2	880
225 (40+65+65+60)	221,2-226,2	1203+1205+1208x2	879
225 (30+70+70+60)	221,2-226,2	1202+1205+1209x2	883
225 (40+70+70+50)	221,2-226,2	1203+1204+1209x2	884
225 (20+80+80+50)	221,2-226,2	1200+1204+1210x2	892
225 (30+80+80+40)	221,2-226,2	1202+1203+1210x2	892
230 (25+80+80+50)	226,2-231,2	1201+1204+1210x2	900
235 (50+65+65+60)	231,2-236,2	1204+1205+1208x2	895
235 (40+70+70+60)	231,2-236,2	1203+1205+1209x2	899
235 (50+70+70+50)	231,2-236,2	1204x2+1209x2	900
235 (20+80+80+60)	231,2-236,2	1200+1205+1210x2	907
235 (40+80+80+40)	231,2-236,2	1203x2+1210x2	908
240 (25+80+80+60)	236,2-241,2	1201+1205+1210x2	915
245 (60+65+65+60)	241,2-246,2	1205x2+1208x2	910
245 (50+70+70+60)	241,2-246,2	1204+1205+1209x2	915
245 (30+80+80+60)	241,2-246,2	1202+1205+1210x2	923
245 (40+80+80+50)	241,2-246,2	1203+1204+1210x2	924
255 (60+70+70+60)	251,2-256,2	1205x2+1209x2	930
255 (40+80+80+60)	251,2-256,2	1203+1205+1210x2	939
255 (50+80+80+50)	251,2-256,2	1204x2+1210x2	940
265 (50+80+80+60)	261,2-266,2	1204+1205+1210x2	955
275 (60+80+80+60)	271,2-276,2	1205x2+1210x2	970

**COMBINACIONES  
FROST PLUS +70 puntos**

\*Permite unión con Lateral fijo STD en ambos lados (rango mínimo +0,7 cm / ajuste 2,5 cm), ver pág. 202.

\*Permite uso perfil compensación en ambos lados

Descripción	Ref.	Puntos
Perfil compensación lado fijo +3 cm	0218	25
Perfil compensación lado fijo +6 cm	0029	35
Juego gomas imán expansión +1,2 cm, ver pág. 285	1221	24

# OPEN COMBI H angular 2 puertas abatibles + 2 fijos



## FIJOS

Rango cm	TRANSPARENTE		FROST PLUS	
	Ref.	Puntos	Ref.	Puntos
17,5/20	1200	120	-	-
22,5/25	1201	128	-	-
27,5/30	1202	136	1280	146
37,5/40	1203	152	1281	162
47,5/50	1204	168	1282	178
57,5/60	1205	183	1283	193

(2,5 ajuste)



Paneles fijos a medida (ver pág. 281)

## PUERTAS

Medida cm	TRANSPARENTE		FROST PLUS	
	Ref.	Puntos	Ref.	Puntos
2 PUERTAS 76,2	1206	401	-	-
39,5	1216	237	-	-
44,5	1217	244	-	-
49,5	1207	250	1284	275
54,5	1218	259	1285	284
59,5	1219	267	1286	292
64,5	1208	272	1287	297
69,5	1209	282	1288	307
74,5	1220	297	1289	322
79,5	1210	302	1290	327
84,5	1223	312	1291	337

(sin ajuste)

Ejemplo combinando 1200 + 1207 = 17,5 + 49,5 + 2,5 de ajuste = 67-69,5 cm. Puntos 120 + 250 = 370 (1 lado)  
 suma rango mínimo de los fijos + medida de las puertas + 2,5 cm de ajuste



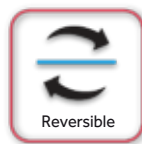

## COMBI H

Combinación con puertas 40, 50, 65, 70 y 80

Medidas (F+P+P+F)	Rango	Referencia	Puntos
70x70(30+40+40+30)	67-69,5	1202x2+1206	673
70X70(20+50+50+20)	67-69,5	1200x2+1207x2	740
75X75(25+50+50+25)	72-74,5	1201x2+1207x2	756
80x80(40+40+40+40)	77-79,5	1203x2+1206	705
80X80(30+50+50+30)	77-79,5	1202x2+1207x2	772
85x85(20+65+65+20)	82-85,5	1200x2+1208x2	784
90x90(50+40+40+50)	87-89,5	1204x2+1206	737
90x90(40+50+50+40)	87-89,5	1203x2+1207x2	804
90x90(25+65+65+25)	87-89,5	1201x2+1208x2	800
90x90(20+70+70+20)	87-89,5	1200x2+1209x2	804
95x95(30+65+65+30)	92-94,5	1202x2+1208x2	816
100x100(60+40+40+60)	97-99,5	1205x2+1206	767
100x100(30+70+70+30)	97-99,5	1202x2+1209x2	836
100x100(50+50+50+50)	97-99,5	1204x2+1207x2	836
90x70(50+40+40+30)	87-89,5 / 67-69,5	1204+1202+1206	705
90x70(40+50+50+20)	87-89,5 / 67-69,5	1203+1200+1207x2	772
90x70(25+65+50+20)	87-89,5 / 67-69,5	1201+1208+1200+1207	770
90x70(20+70+50+20)	87-89,5 / 67-69,5	1200x2+1209+1207	772
95x70(30+65+50+20)	92-94,5 / 67-69,5	1202+1208+1200+1207	778
95x70(25+70+50+20)	92-94,5 / 67-69,5	1201+1209+1200+1207	780
100x70(60+40+40+30)	97-99,5 / 67-69,5	1205+1202+1206	720
100x70(30+70+50+20)	97-99,5 / 67-69,5	1202+1209+1200+1207	788
100x70(20+80+50+20)	97-99,5 / 67-69,5	1200x2+1210+1207	792
105x70(40+65+50+20)	102-104,5 / 67-69,5	1203+1208+1200+1207	794
105x70(25+80+50+20)	102-104,5 / 67-69,5	1201+1210+1200+1207	800
110x70(40+70+50+20)	107-109,5 / 67-69,5	1203+1209+1200+1207	804
110x70(30+80+50+20)	107-109,5 / 67-69,5	1202+1210+1200+1207	808
110x70(60+50+50+20)	107-109,5 / 67-69,5	1205+1207+1200+1207	803
115x70(50+65+50+20)	112-114,5 / 67-69,5	1204+1208+1200+1207	810
120x70(50+70+50+20)	117-119,5 / 67-69,5	1204+1209+1200+1207	820
120x70(40+80+50+20)	117-119,5 / 67-69,5	1203+1210+1200+1207	824

\*Permite uso perfil compensación en ambos lados

Descripción	Ref.	Puntos
Perfil compensación lado fijo +3 cm	0218	25
Perfil compensación lado fijo +6 cm	0029	35

## COMBI H

Combinación con puertas 40, 50, 65, 70 y 80

Medidas (F+P+P+F)	Rango	Referencia	Puntos
125x70(60+65+50+20)	122-124,5 / 67-69,5	1205+1208+1200+1207	825
130x70(50+80+50+20)	127-129,5 / 67-69,5	1204+1210+1200+1207	840
130x70(60+70+50+20)	127-129,5 / 67-69,5	1205+1209+1200+1207	835
140x70(60+80+50+20)	137-139,4 / 67-69,5	1205+1210+1200+1207	855
90x80(50+40+40+40)	87-89,5 / 77-79,5	1204+1203+1206	721
90x80(40+50+50+30)	87-89,5 / 77-79,5	1203+1202+1207x2	788
90x80(25+65+50+30)	87-89,5 / 77-79,5	1201+1208+1202+1207	786
90x80(20+70+50+30)	87-89,5 / 77-79,5	1200+1209+1207+1202	788
95x80(30+65+50+30)	92-94,5 / 77-79,5	1202+1208+1202+1207	794
95x80(25+70+50+30)	92-94,5 / 77-79,5	1201+1209+1202+1207	796
100x80(60+40+40+40)	97-99,5 / 77-79,5	1205+1203+1206	736
100x80(30+70+50+30)	97-99,5 / 77-79,5	1202+1209+1202+1207	804
100x80(20+80+50+30)	97-99,5 / 77-79,5	1210+1200+1202+1207	808
105x80(40+65+50+30)	102-104,5 / 77-79,5	1203+1208+1202+1207	810
105x80(25+80+50+30)	102-104,5 / 77-79,5	1201+1210+1202+1207	816
110X80(60+50+50+30)	107-109,5 / 77-79,5	1205+1207+1202+1207	819
110X80(40+70+50+30)	107-109,5 / 77-79,5	1203+1209+1202+1207	820
110X80(30+80+50+30)	107-109,5 / 77-79,5	1202x2+1210+1207	824
115X80(50+65+50+30)	112-114,5 / 77-79,5	1204+1208+1202+1207	826
120x80(50+70+50+30)	117-119,5 / 77-79,5	1204+1209+1202+1207	836
120x80(40+80+50+30)	117-119,5 / 77-79,5	1203+1210+1202+1207	840
125x80(60+65+50+30)	122-124,5 / 77-79,5	1205+1208+1202+1207	841
130x80(50+80+50+30)	127-129,5 / 77-79,5	1204+1210+1202+1207	856
130x80(60+70+50+30)	127-129,5 / 77-79,5	1205+1209+1202+1207	851
140x80(60+80+50+30)	137-139,5 / 77-79,5	1205+1210+1202+1207	871
95x90(30+65+50+40)	92-94,5 / 87-89,5	1202+1208+1203+1207	810
95x90(25+70+50+40)	92-94,5 / 87-89,5	1201+1209+1203+1207	812
95x90(30+65+65+25)	92-94,5 / 87-89,5	1202+1201+1208x2	808
95x90(25+70+65+25)	92-94,5 / 87-89,5	1201+1209+1201+1208	810
95x90(30+65+70+20)	92-94,5 / 87-89,5	1202+1208+1200+1209	810
95x90(25+70+70+20)	92-94,5 / 87-89,5	1201+1200+1209x2	812

# COMBINACIONES FROST PLUS +70 puntos

MÁS COMBINACIONES EN PÁGINA SIGUIENTE

# OPEN COMBI H angular 2 puertas abatibles + 2 fijos



## FIJOS

Rango cm	TRANSPARENTE		FROST PLUS	
	Ref.	Puntos	Ref.	Puntos
17,5/20	1200	120	-	-
22,5/25	1201	128	-	-
27,5/30	1202	136	1280	146
37,5/40	1203	152	1281	162
47,5/50	1204	168	1282	178
57,5/60	1205	183	1283	193

(2,5 ajuste)



Paneles fijos a medida (ver pág. 281)

## PUERTAS

Medida cm	TRANSPARENTE		FROST PLUS	
	Ref.	Puntos	Ref.	Puntos
2 PUERTAS 76,2	1206	401	-	-
39,5	1216	237	-	-
44,5	1217	244	-	-
49,5	1207	250	1284	275
54,5	1218	259	1285	284
59,5	1219	267	1286	292
64,5	1208	272	1287	297
69,5	1209	282	1288	307
74,5	1220	297	1289	322
79,5	1210	302	1290	327
84,5	1223	312	1291	337

(sin ajuste)

Ejemplo combinando 1200 + 1207 = 17,5 + 49,5 + 2,5 de ajuste = 67-69,5 cm. Puntos 120 + 250 = 370 (1 lado)  
 suma rango mínimo de los fijos + medida de las puertas + 2,5 cm de ajuste



## COMBI H

Combinación con puertas 40, 50, 65, 70 y 80

Medidas (F+P+P+F)	Rango	Referencia	Puntos
100x90(60+40+40+50)	97-99,5 / 87-89,5	1205+1204+1206	752
100x90(30+70+50+40)	97-99,5 / 87-89,5	1202+1209+1203+1207	820
100x90(20+80+50+40)	97-99,5 / 87-89,5	1200+1210+1203+1207	824
100x90(30+70+65+25)	97-99,5 / 87-89,5	1202+1209+1201+1208	818
100x90(20+80+65+25)	97-99,5 / 87-89,5	1200+1210+1201+1208	822
100x90(30+70+70+20)	97-99,5 / 87-89,5	1202+1200+1209x2	820
100x90(20+80+70+20)	97-99,5 / 87-89,5	1200x2+1210+1209	824
105x90(40+65+50+40)	102-104,5 / 87-89,5	1203x2+1208+1207	826
105x90(25+80+50+40)	102-104,5 / 87-89,5	1201+1210+1203+1207	832
105x90(40+65+65+25)	102-104,5 / 87-89,5	1203+1201+1208x2	824
105x90(25+80+65+25)	102-104,5 / 87-89,5	1201x2+1210+1208	830
105x90(40+65+70+20)	102-104,5 / 87-89,5	1203+1208+1200+1209	826
105x90(25+80+70+20)	102-104,5 / 87-89,5	1201+1210+1200+1209	832
110x90(60+50+50+40)	107-109,5 / 87-89,5	1205+1203+1207x2	835
110x90(40+70+50+40)	107-109,5 / 87-89,5	1203x2+1209+1207	836
110x90(30+80+50+40)	107-109,5 / 87-89,5	1202+1210+1203+1207	840
110x90(60+50+65+25)	107-109,5 / 87-89,5	1205+1207+1201+1208	833
110x90(40+70+65+25)	107-109,5 / 87-89,5	1203+1209+1201+1208	834
110x90(30+80+65+25)	107-109,5 / 87-89,5	1202+1210+1201+1208	838
110x90(60+50+70+20)	107-109,5 / 87-89,5	1205+1207+1200+1209	835
110x90(40+70+70+20)	107-109,5 / 87-89,5	1203+1200+1209x2	836
110x90(30+80+70+20)	107-109,5 / 87-89,5	1202+1210+1200+1209	840

## COMBI H

Combinación con puertas 40, 50, 65, 70 y 80

Medidas (F+P+P+F)	Rango	Referencia	Puntos
115x90(50+65+50+40)	112-114,5 / 87-89,5	1204+1208+1203+1207	842
115x90(50+65+65+25)	112-114,5 / 87-89,5	1204+1201+1208x2	840
115x90(50+65+70+20)	112-114,5 / 87-89,5	1204+1208+1200+1209	842
120x90(50+70+50+40)	117-119,5 / 87-89,5	1204+1209+1203+1207	852
120x90(40+80+50+40)	117-119,5 / 87-89,5	1203x2+1210+1207	856
120x90(50+70+65+25)	117-119,5 / 87-89,5	1204+1209+1201+1208	850
120x90(40+80+65+25)	117-119,5 / 87-89,5	1203+1210+1201+1208	854
120x90(50+70+70+20)	117-119,5 / 87-89,5	1204+1200+1209x2	852
120x90(40+80+70+20)	117-119,5 / 87-89,5	1203+1210+1200+1209	856
125x90(60+65+50+40)	122-124,5 / 87-89,5	1205+1208+1203+1207	857
125x90(60+65+65+25)	122-124,5 / 87-89,5	1205+1201+1208x2	855
125x90(60+65+70+20)	122-124,5 / 87-89,5	1205+1208+1200+1209	857
130x90(60+70+50+40)	127-129,5 / 87-89,5	1205+1209+1203+1207	867
130x90(50+80+50+40)	127-129,5 / 87-89,5	1204+1210+1203+1207	872
130x90(60+70+65+25)	127-129,5 / 87-89,5	1205+1209+1201+1208	865
130x90(50+80+65+25)	127-129,5 / 87-89,5	1204+1210+1201+1208	870
130x90(60+70+70+20)	127-129,5 / 87-89,5	1205+1200+1209x2	867
130x90(50+80+70+20)	127-129,5 / 87-89,5	1204+1210+1200+1209	872
140x90(60+80+50+40)	137-139,5 / 87-89,5	1205+1210+1203+1207	887
140x90(60+80+65+25)	137-139,5 / 87-89,5	1205+1210+1201+1208	885
140x90(60+80+70+20)	137-139,5 / 87-89,5	1205+1210+1200+1209	887

\*Permite uso perfil compensación en ambos lados

Descripción	Ref.	Puntos
Perfil compensación lado fijo +3 cm	0218	25
Perfil compensación lado fijo +6 cm	0029	35

**COMBINACIONES FROST PLUS**  
**+70 puntos**



Opción barras + soportes Ref. 1716x2+1730  
Incremento 135 puntos

OPEN COMBI I 2 puertas abatibles





H195

Altura



6mm

Grosor cristal



Opción 180°



1.5cm

Expansión

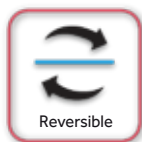

Reversible



aluminio  
AL  
aluminium



antical  
clear  
shield  
glass



● Negro

Ver pág. 223

## COMBI I

Medidas	Rango	Apert.	TRANSPARENTE		FROST PLUS	
			Referencias	Puntos	Referencias	Puntos
80 (40+40)	79-82	66	1206+1211x2	451	-	-
85 (40+45)	84-87	71	1216+1217+1211x2	531	-	-
90 (45+45)	89-92	76	1217x2+1211x2	538	-	-
95 (45+50)	94-97	81	1217+1207+1211x2	544	-	-
100 (50+50)	99-102	86	1207x2+1211x2	550	1284x2+1211x2	600
105 (50+55)	104-107	91	1207+1218+1211x2	559	1284+1285+1211x2	609
110 (55+55)	109-112	96	1218x2+1211x2	568	1285x2+1211x2	618
115 (55+60)	114-117	101	1218+1219+1211x2	576	1285+1286+1211x2	626
120 (60+60)	119-122	106	1219x2+1211x2	584	1286x2+1211x2	634
125 (60+65)	124-127	111	1219+1208+1211x2	589	1286+1287+1211x2	639
130 (65+65)	129-132	116	1208x2+1211x2	594	1287x2+1211x2	644
135 (65+70)	134-137	121	1208+1209+1211x2	604	1287+1288+1211x2	654
140 (70+70)	139-142	126	1209x2+1211x2	614	1288x2+1211x2	664
145 (70+75)	144-147	131	1209+1220+1211x2	629	1288+1289+1211x2	679
150 (75+75)	149-152	136	1220x2+1211x2	644	1289x2+1211x2	694
155 (75+80)	154-157	141	1220+1210+1211x2	649	1289+1290+1211x2	699
160 (80+80)	159-162	146	1210x2+1211x2	654	1290x2+1211x2	704
165 (80+85)	164-167	151	1210+1223+1211x2	664	1290+1291+1211x2	714
170 (85+85)	169-172	156	1223x2+1211x2	674	1291x2+1211x2	724

\*Permite unión con Lateral fijo STD con ref. 1222 (rango mínimo +1,8 / expansión 1,5), ver pág. 202.

Descripción	Ref.	Puntos
Juego gomas imán expansión +1,2 cm, ver pág. 285	1221	24
Perfil expensor puerta +2,5 cm, ver pág. 285	1222	48
Perfil puerta (reduce hasta 1 cm el rango), ver pág. 285	1215	29

# OPEN COMBI J 2 puertas abatibles + fijo



Opción barra 140 cm, ref. 1716 + 60 puntos  
Opción barra 200 cm, ref. 1717 + 80 puntos

## FIJOS

Rango cm	TRANSPARENTE		FROST PLUS	
	Ref.	Puntos	Ref.	Puntos
17,5/20	1200	120	-	-
22,5/25	1201	128	-	-
27,5/30	1202	136	1280	146
37,5/40	1203	152	1281	162
47,5/50	1204	168	1282	178
57,5/60	1205	183	1283	193

(2,5 ajuste)

Perfil puerta ref. 1211	25
-------------------------	----



Paneles fijos a medida (ver pág. 281)

## PUERTAS

Medida cm	TRANSPARENTE		FROST PLUS	
	Ref.	Puntos	Ref.	Puntos
2 PUERTAS 76,2	1206	401	-	-
38,6	1216	237	-	-
43,6	1217	244	-	-
48,6	1207	250	1284	275
53,6	1218	259	1285	284
58,6	1219	267	1286	292
63,6	1208	272	1287	297
68,6	1209	282	1288	307
73,6	1220	297	1289	322
78,6	1210	302	1290	327
83,6	1223	312	1291	337

(1,5 ajuste)

Ejemplo combinando 1200+1207+1207+1211= 17,5+48,6+48,6 +4 cm de ajuste = 114,7-118,7 cm. Puntos 120+250+250+25 = 645  
sume rango mínimo de los fijos + medida de las puertas + 4 cm de ajuste

\*Recuerden sumar 29 puntos del perfil de pared ref. 1211



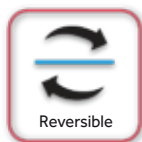

## COMBI J

Medidas (P+P+F)	Rango	Apert.	TRANSPARENTE		FROST PLUS	
			Referencias	Puntos	Referencias	Puntos
95 (40+40+20)	94,8/98,8	66	1206+1200+1211	546	-	-
100 (40+40+25)	99,8/103,8	66	1206+1201+1211	554	-	-
105 (40+40+30)	104,8/108,8	66	1206+1202+1211	562	-	-
110 (45+45+25)	109,8/113,8	76	1217X2+1201+1211	641	-	-
115 (45+45+30)	114,8/118,8	76	1217X2+1202+1211	649	-	-
120 (50+50+25)	119,8/123,8	86	1207X2+1201+1211	653	-	-
125 (50+50+30)	124,8/128,8	86	1207X2+1202+1211	661	1284X2+1280+1211	721
130 (50+55+30)	129,8/133,8	91	1207+1218+1202+1211	670	1284+1285+1280+1211	730
135 (50+50+40)	134,8/138,8	86	1207X2+1203+1211	677	1284X2+1281+1211	737
140 (60+55+30)	139,8/143,8	101	1219+1218+1202+1211	687	1286+1285+1280+1211	747
145 (45+45+60)	144,8/148,8	76	1217X2+1205+1211	696	-	-
145 (50+50+50)	144,8/148,8	86	1207X2+1204+1211	693	1284X2+1282+1211	753
145 (60+60+30)	144,8/148,8	106	1219X2+1202+1211	695	1286X2+1280+1211	755
155 (55+55+50)	154,8/158,8	96	1218X2+1204+1211	711	1285X2+1282+1211	771
160 (60+55+50)	159,8/163,8	101	1219+1218+1204+1211	719	1286+1285+1282+1211	779
165 (65+65+40)	164,8/168,8	116	1208X2+1203+1211	721	1287X2+1281+1211	781
170 (75+70+30)	169,8/173,8	131	1220+1209+1202+1211	740	1289+1288+1280+1211	800
175 (75+75+30)	174,8/178,8	136	1220X2+1202+1211	755	1289X2+1280+1211	815
180 (80+75+30)	179,8/183,8	141	1210+1220+1202+1211	760	1290+1289+1280+1211	820
185 (80+80+30)	184,8/188,8	146	1210X2+1202+1211	765	1290X2+1280+1211	825
190 (65+70+60)	189,8/193,8	121	1208+1209+1205+1211	762	1287+1288+1283+1211	822
195 (75+75+50)	194,8/198,8	136	1220X2+1204+1211	787	1289X2+1282+1211	847
200 (65+80+60)	199,8/203,8	131	1208+1210+1205+1211	782	1287+1290+1283+1211	842
205 (80+80+50)	204,8/208,8	146	1210X2+1204+1211	797	1290X2+1282+1211	857
210 (80+75+60)	209,8/213,8	141	1220+1210+1205+1211	807	1289+1290+1283+1211	867
215 (80+80+60)	214,8/218,8	146	1210X2+1205+1211	812	1290X2+1283+1211	872

\*Permite combinación con Lateral fijo STD en lado puerta usando ref.1222, rango mínimo +1,8 / expansión 2,5 cm (ver pág. 202)

\*Permite combinación con Lateral fijo STD en lado del fijo, rango mínimo +0,7 / expansión 1,5 cm (ver pág. 202)

Descripción	Ref.	Puntos
Perfil compensación lado fijo +3 cm	0218	25
Perfil compensación lado fijo +6 cm	0029	35
Perfil puerta (reduce hasta 1 cm el rango), ver pág. 285	1215	29
Juego gomas imán expansión +1,2 cm, ver pág. 285	1221	24
Perfil expansor puerta +2,5 cm, ver pág. 285	1222	48
Juego gomas apertura IN-OUT 180°	1213	38

# OPEN COMBI K 2 puertas angular

● Negro  
Ref. pág. 223



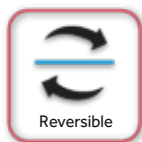

## COMBI K

Medidas (P+P)	Rango	Apert.
40x40	40,4-41,9 / 40,4-41,9	66
40x45	40,4-41,9 / 45,4-46,9	71
45x45	45,4-46,9 / 45,4-46,9	76
45x50	45,4-46,9 / 50,4-51,9	81
45x55	45,4-46,9 / 55,4-56,9	86
45x60	45,4-46,9 / 60,4-61,9	91
45x65	45,4-46,9 / 65,4-66,9	96
45x70	45,4-46,9 / 70,4-71,9	101
45x75	45,4-46,9 / 75,4-76,9	106
45x80	45,4-46,9 / 80,4-81,9	111
50x50	50,4-51,9 / 50,4-51,9	86
50x55	50,4-51,9 / 55,4-56,9	91
50x60	50,4-51,9 / 60,4-61,9	96
50x65	50,4-51,9 / 65,4-66,9	101
50x70	50,4-51,9 / 70,4-71,9	106
50x75	50,4-51,9 / 75,4-76,9	111
50x80	50,4-51,9 / 80,4-81,9	116
55x55	55,4-56,9 / 55,4-56,9	96
55x60	55,4-56,9 / 60,4-61,9	101
55x65	55,4-56,9 / 65,4-66,9	106
55x70	55,4-56,9 / 70,4-71,9	111
55x75	55,4-56,9 / 75,4-76,9	116
55x80	55,4-56,9 / 80,4-81,9	121
60x60	60,4-61,9 / 60,4-61,9	106
60x65	60,4-61,9 / 65,4-66,9	111
60x70	60,4-61,9 / 70,4-71,9	116
60x75	60,4-61,9 / 75,4-76,9	121
60x80	60,4-61,9 / 80,4-81,9	126
65x65	65,4-66,9 / 65,4-66,9	116
65x70	65,4-66,9 / 70,4-71,9	121
65x75	65,4-66,9 / 75,4-76,9	126
65x80	65,4-66,9 / 80,4-81,9	131
70x70	70,4-71,9 / 70,4-71,9	126
70x75	70,4-71,9 / 75,4-76,9	131
70x80	70,4-71,9 / 80,4-81,9	136
75x75	75,4-76,9 / 75,4-76,9	136
75x80	75,4-76,9 / 80,4-81,9	141
80x80	80,4-81,9 / 80,4-81,9	146
80x85	80,4-81,9 / 85,4-86,9	151
85x85	85,4-86,9 / 85,4-86,9	156

## TRANSPARENTES

Referencias	Puntos
1211x2 +1206	451
1211x2 +1216+1217	531
1211x2+1217x2	538
1211x2+1217+1207	544
1211x2+1217+1218	553
1211x2+1217+1219	561
1211x2+1217+1208	566
1211x2+1217+1209	576
1211x2+1217+1220	591
1211x2+1217+1210	596
1211x2 + 1207x2	550
1211x2+1207+1218	559
1211x2+1207+1219	567
1211x2+1207+1208	572
1211x2+1207+1209	582
1211x2+1207+1220	597
1211x2+1207+1210	602
1211x2+1218x2	568
1211x2+1218+1219	576
1211x2+1218+1208	581
1211x2+1218+1209	591
1211x2+1218+1220	606
1211x2+1218+1210	611
1211x2+1219x2	584
1211x2+1219+1208	589
1211x2+1219+1209	599
1211x2+1219+1220	614
1211x2+1219+1210	619
1211x2+1208x2	594
1211x2+1208+1209	604
1211x2+1208+1220	619
1211x2+1208+1210	624
1211x2+1209x2	614
1211x2+1209+1220	629
1211x2+1209+1210	634
1211x2+1220x2	644
1211x2+1220+1210	649
1211x2+1210x2	654
1210+1223+1211x2	664
1223x2+1211x2	674

## FROST PLUS

Referencias	Puntos
-	-
-	-
-	-
-	-
-	-
-	-
-	-
-	-
-	-
-	-
1211x2 + 1284x2	600
1211x2+1284+1285	609
1211x2+1284+1286	617
1211x2+1284+1287	622
1211x2+1284+1288	632
1211x2+1284+1289	647
1211x2+1284+1290	652
1211x2+1285x2	618
1211x2+1285+1286	626
1211x2+1285+1287	631
1211x2+1285+1288	641
1211x2+1285+1289	656
1211x2+1285+1290	661
1211x2+1286x2	634
1211x2+1286+1287	639
1211x2+1286+1288	649
1211x2+1286+1289	664
1211x2+1286+1290	669
1211x2+1287x2	644
1211x2+1287+1288	654
1211x2+1287+1289	669
1211x2+1287+1290	674
1211x2+1288x2	664
1211x2+1288+1289	679
1211x2+1288+1290	684
1211x2+1289x2	694
1211x2+1289+1290	699
1211x2+1290x2	704
1290+1291+1211x2	714
1291x2+1211x2	724

Perfil compensación lado puerta +2,5 cm, ver pág. 285

1222 48

Perfil puerta (reduce hasta 1 cm el rango), ver pág. 285

1215 29

# OPEN/GLASS

## Lateral fijo STD transparente

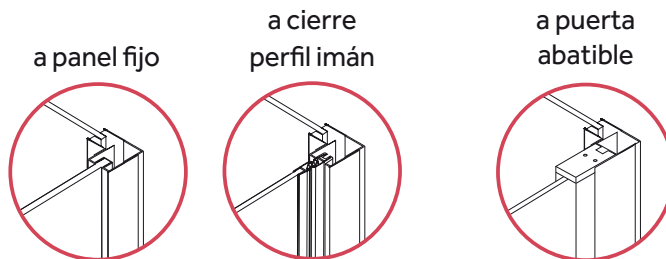

Si la unión es al lado fijo o al cierre perfil imán ref. 1212, se sumaran +0,7 cm al rango mín. de la combinación + expansión del lado libre de lateral fijo. La expansión del lado donde va el lateral fijo se pierde.

Si la unión es al lado puerta se debe utilizar la ref. 1222, se sumaran +1,8 cm al rango mínimo de la combinación + expansión del lado libre de lateral fijo.

Combi E 30+70 + lat. fijo STD 70  
Refs. 1202+1209+1211+0814+1214



Disponible para combinaciones			
<b>COMBI A</b> lado perfil puerta		<b>COMBI B</b> ambos lados	
<b>COMBI C</b> lado fijo		<b>COMBI D</b> ambos lados	
<b>COMBI E</b> ambos lados		<b>COMBI F</b> ambos lados	
<b>COMBI G</b> ambos lados		<b>COMBI I</b> ambos lados	
<b>COMBI J</b> ambos lados			

### laterales fijos STD TRANSPARENTES 8 mm

Descripción	Rango	Referencias	Puntos
Lateral fijo STD 30x195 + brazo	26-29	0810+1214	193
Lateral fijo STD 40x195 + brazo	36-39	0811+1214	203
Lateral fijo STD 50x195 + brazo	46-49	0812+1214	213
Lateral fijo STD 60x195 + brazo	56-59	0813+1214	223
Lateral fijo STD 70x195 + brazo	66-69	0814+1214	233
Lateral fijo STD 75x195 + brazo	71-74	0820+1214	238
Lateral fijo STD 80x195 + brazo	76-79	0815+1214	243
Lateral fijo STD 90x195 + brazo	86-89	0816+1214	258

GLASS, sustituir brazo 1214 por brazo 1715, puntos 34



Opción barra paralela 140 cm ref. 1716+1718+5568  
Incremento 56 p. (descontado brazo 1214)  
Opción barra paralela 200 cm ref. 1717+1718+5568  
Incremento 76 p. (descontado brazo 1214)

Descripción	Ref.	Puntos
Perfil compensación +2 cm	0218	25
Perfil compensación +4 cm	0029	35
Perfil compensación +5,5 cm	0219	35



### Laterales fijos a medida STD TRANSPARENTE 8 mm (más información en página 282)

Descripción	Referencias	Puntos	Cajonado
Lateral fijo a medida STD hasta 40 cm + brazo	1343+1214	213	+21
Lateral fijo a medida STD de 40 hasta 80 cm + brazo	1304+1214	288	+21
Lateral fijo a medida STD de 80 hasta 120 cm + brazo	1310+1214	358	+21

\*Plazo de entrega 15 días

# OPEN

## Lateral fijo STD Frost Plus

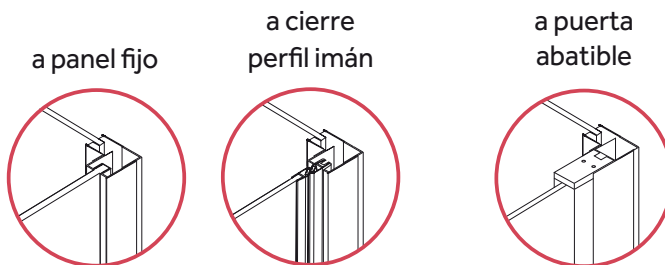

Combi C Frost 30+70 + lat. fijo Frost STD 70 + barra paralela  
Refs. 1280+1288+1211+0817+1716+1718+5568



Si la unión es al lado fijo o al cierre perfil imán ref. 1212, se sumaran +0,7 cm al rango mín. de la combinación + expansión del lado libre de lateral fijo. La expansión del lado donde va el lateral fijo se pierde.

Si la unión es al lado puerta se debe utilizar la ref. 1222, se sumaran +1,8 cm al rango mínimo de la combinación + expansión del lado libre de lateral fijo.

### Disponible para combinaciones

<b>COMBI A</b> lado perfil puerta		<b>COMBI B</b> ambos lados	
<b>COMBI C</b> lado fijo		<b>COMBI D</b> ambos lados	
<b>COMBI G</b> ambos lados		<b>COMBI I</b> ambos lados	
<b>COMBI J</b> ambos lados			

### laterales fijos STD FROST PLUS 8 mm

Descripción	Rango	Referencias	Puntos
Lateral fijo STD 70x195 + brazo	66-69	0817+1214	268
Lateral fijo STD 80x195 + brazo	76-79	0818+1214	278
Lateral fijo STD 90x195 + brazo	86-89	0819+1214	288



Opción barra paralela 140 cm ref. 1716+1718+5568  
Incremento 56 p. (descontado brazo 1214)  
Opción barra paralela 200 cm ref. 1717+1718+5568  
Incremento 76 p. (descontado brazo 1214)

Descripción	Referencias	Puntos
Perfil compensación +2 cm	0218	25
Perfil compensación +4 cm	0029	35
Perfil compensación +5,5 cm	0219	35



### Laterales fijos a medida STD FROST PLUS 8 mm (más información en página 282)

Descripción	Referencias	Puntos	Cajonado
Lateral fijo a medida STD hasta 40 cm + brazo	1343+1312+1214	335	+21
Lateral fijo a medida STD de 40 hasta 80 cm + brazo	1304+1313+1214	410	+21
Lateral fijo a medida STD de 80 hasta 120 cm + brazo	1310+1315+1214	480	+21

\*Plazo de entrega 15 días

# OPEN BLACK COMBI A puerta con cierre imán a pared



\*Opción instalación formato free, rango -3cm

## COMBI A Frontal de 1 puerta con cierre imán a pared

Descripción	Medida	Rango	Apertura	Referencias	Puntos
Frontal ducha OPEN 50 con cierre imán a pared	50	51,1-52,6	43	9004 + 9012	280
Frontal ducha OPEN 55 con cierre imán a pared	55	56,1-57,6	48	9005 + 9012	289
Frontal ducha OPEN 60 con cierre imán a pared	60	61,1-62,6	53	9006 + 9012	297
Frontal ducha OPEN 65 con cierre imán a pared	65	66,1-67,6	58	9007 + 9012	302
Frontal ducha OPEN 70 con cierre imán a pared	70	71,1-72,6	63	9008 + 9012	312
Frontal ducha OPEN 75 con cierre imán a pared	75	76,1-77,6	68	9009 + 9012	327
Frontal ducha OPEN 80 con cierre imán a pared	80	81,1-82,6	73	9010 + 9012	332
Frontal ducha OPEN 85 con cierre imán a pared	85	86,1-87,6	78	9011 + 9012	342

Descripción	Referencias	Puntos
Perfil expansor puerta (+1,5 a +3 cm)	9015	48
Perfil puerta (reduce hasta 1 cm el rango)	9014	25
Juego gomas imán expansión +1,2 cm	1221	24
Juego gomas apertura IN-OUT 180°	1213	38



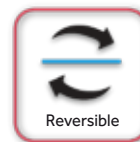

Opción barra 140 cm más soporte lateral fijo-Ref. 9026+9028  
Incremento 38 puntos (ya descontado brazo 9017)

Apertura exterior  
90° p/fijo



Opción in-out  
0180° p/fijo



El rango del frontal aumenta 1,4 cm y  
el rango del lateral fijo se reduce 1 cm  
Ref. 0038 - Incremento 21 puntos

### COMBI A + LATERAL FIJO 70 C/BRAZO 9017

Medidas	Rangos	Referencias	Puntos
50X70	50,6-52,1/66-69	9004+9012+9018+9017	476
55X70	55,6-57,1/66-69	9005+9012+9018+9017	485
60X70	60,6-62,1/66-69	9006+9012+9018+9017	493
65X70	65,6-67,1/66-69	9007+9012+9018+9017	498
70X70	70,6-72,1/66-69	9008+9012+9018+9017	508
75X70	75,6-77,1/66-69	9009+9012+9018+9017	523
80X70	80,6-82,1/66-69	9010+9012+9018+9017	528
85X70	85,6-87,1/66-69	9011+9012+9018+9017	538

### COMBI A + LATERAL FIJO 80 C/BRAZO 9017

Medidas	Rangos	Referencias	Puntos
50X80	50,6-52,1/76-79	9004+9012+9019+9017	486
55X80	55,6-57,1/76-79	9005+9012+9019+9017	495
60X80	60,6-62,1/76-79	9006+9012+9019+9017	503
65X80	65,6-67,1/76-79	9007+9012+9019+9017	508
70X80	70,6-72,1/76-79	9008+9012+9019+9017	518
75X80	75,6-77,1/76-79	9009+9012+9019+9017	533
80X80	80,6-82,1/76-79	9010+9012+9019+9017	538
85X80	85,6-87,1/76-79	9011+9012+9019+9017	548

### COMBI A + LATERAL FIJO 90 C/BRAZO 9017

Medidas	Rangos	Referencias	Puntos
50X90	50,6-52,1/86-89	9004+9012+9020+9017	496
55X90	55,6-57,1/86-89	9005+9012+9020+9017	505
60X90	60,6-62,1/86-89	9006+9012+9020+9017	513
65X90	65,6-67,1/86-89	9007+9012+9020+9017	518
70X90	70,6-72,1/86-89	9008+9012+9020+9017	528
75X90	75,6-77,1/86-89	9009+9012+9020+9017	543
80X90	80,6-82,1/86-89	9010+9012+9020+9017	548
85X90	85,6-87,1/86-89	9011+9012+9020+9017	558

Las aperturas son las mismas que en los frontales.

### Laterales fijos TRANSPARENTES 6 mm

Descripción	Rango	Ref.	Puntos
Lateral fijo 70x195	66-69	9018	158
Lateral fijo 80x195	76-79	9019	168
Lateral fijo 90x195	86-89	9020	178
Brazo open		9017	38

Descripción	Ref.	Puntos
Perfil compensación para lateral fijo +3 cm	9016	29

### Laterales fijos a medida 6 mm (más información en página 282)

Descripción	Ref.	Puntos	Cajonado
Lateral fijo a medida OPEN BLACK hasta 40 cm	1345N	207	+21
Lateral fijo a medida OPEN BLACK de 40 hasta 80 cm	1316N	282	+21
Lateral fijo a medida OPEN BLACK de 80 hasta 120 cm	1317N	352	+21

\*Plazo de entrega 15 días.

OPEN BLACK COMBI B puerta con cierre perfil imán



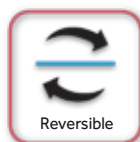

## COMBI B frontal de 1 puerta con cierre perfil imán

Descripción	Medida	Rango	Apertura	Referencias	Puntos
OPEN 55 con cierre perfil imán	55	53,6-57,6	43	9004 + 9012 + 9013	350
OPEN 60 con cierre perfil imán	60	58,6-62,6	48	9005 + 9012 + 9013	359
OPEN 65 con cierre perfil imán	65	63,6-67,6	53	9006 + 9012 + 9013	367
OPEN 70 con cierre perfil imán	70	68,6-72,6	58	9007 + 9012 + 9013	372
OPEN 75 con cierre perfil imán	75	73,6-77,6	63	9008 + 9012 + 9013	382
OPEN 80 con cierre perfil imán	80	78,6-82,6	68	9009 + 9012 + 9013	397
OPEN 85 con cierre perfil imán	85	83,6-87,6	73	9010 + 9012 + 9013	402
OPEN 90 con cierre perfil imán	90	88,6-92,6	78	9011 + 9012 + 9013	412

\*Opción con lateral fijo, consultar fábrica.

Descripción	Ref.	Puntos
Perfil compensación lado cierre perfil imán +3 cm	9016	29
Perfil puerta (reduce hasta 1 cm el rango)	9014	25
Juego gomas imán expansión +1,2 cm	1221	24
Perfil expansor lado puerta +2,5 cm	9015	48
Juego gomas apertura IN-OUT 180°	1213	38

# OPEN BLACK COMBI C fijo + puerta abatible cierre imán a pared



Opción barra 140 cm Ref. 9026  
Incremento 60 puntos

## COMBI C

FIJOS	Rango cm	Ref.	Puntos
FIJO 30	27,5/30	9000	146
FIJO 40	37,5/40	9001	162
FIJO 50	47,5/50	9002	178
FIJO 60	57,5/60	9003	193

(2,5 ajuste)



Paneles fijos a medida (ver pág. 281)

PUERTAS	Rango cm	Ref.	Puntos
PUERTA 50	50	9004	255
PUERTA 55	55	9005	264
PUERTA 60	60	9006	272
PUERTA 65	65	9007	277
PUERTA 70	70	9008	287
PUERTA 75	75	9009	302
PUERTA 80	80	9010	307
PUERTA 85	85	9011	317

(sin ajuste)

**H195**

Altura

**6mm**

Grosor cristal



Abatible 90°



Magnético

**2.5 cm**

Expansión

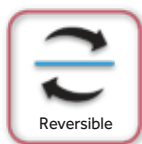

Reversible

aluminio  
**AL**  
aluminiumtratamiento antical  
clear shield glass

## COMBI C

Combinación con puertas de 50, 55, 65, 70, 80 y 85

Medidas	Fijo	Puerta	Rango	Apertura	Referencia	Puntos
80	30	50	77,5-80	43	9000+9004	401
85	30	55	82,5-85	48	9000+9005	410
90	40	50	87,5-90	43	9001+9004	417
95	30	65	92,5-95	58	9000+9007	423
100	30	70	97,5-100	63	9000+9008	433
100	50	50	97,5-100	43	9002+9004	433
105	40	65	102,5-105	58	9001+9007	439
110	30	80	107,5-110	73	9000+9010	453
110	40	70	107,5-110	63	9001+9008	449
110	60	50	107,5-110	43	9003+9004	448
115	50	65	112,5-115	58	9002+9007	455
120	40	80	117,5-120	73	9001+9010	469
120	50	70	117,5-120	63	9002+9008	465
125	60	65	122,5-125	58	9003+9007	470
130	50	80	127,5-130	73	9002+9010	485
130	60	70	127,5-130	63	9003+9008	480
135	60	75	132,5-135	68	9003+9009	495
140	60	80	137,5-140	73	9003+9010	500
145	60	85	142,5-145	78	9003+9011	510

\*Permite combinación con lateral fijo Glass en lado puerta, el rango del frontal se reduce 0,5 cm.

Descripción	Ref.	Puntos
Perfil compensación lado cierre perfil imán +3 cm	9016	29
Perfil puerta (reduce hasta 1 cm el rango)	9014	25
Juego gomas imán expansión +1,2 cm	1221	24
Perfil expansor lado puerta +2,5 cm	9015	48
Juego gomas apertura IN-OUT 180°	1213	38



Opción barra 140 cm Ref. 9026. Incremento 60 puntos.

## COMBI C FREE



\*Opción instalación formato Free, rango -3 cm

# OPEN BLACK COMBI C + lateral fijo



## Laterales fijos TRANSPARENTES 6 mm

Descripción	Rango	Referencias	Puntos
Lateral fijo 70x195	66-69	9018	158
Lateral fijo 80x195	76-79	9019	168
Lateral fijo 90x195	86-89	9020	178
Brazo open		9017	38

Descripción	Referencias	Puntos
Perfil compensación +3 cm lado fijo	9016	29



## Laterales fijos a medida 6 mm (más información en página 282)

Descripción	Ref.	Puntos	Cajonado
Lateral fijo a medida OPEN BLACK hasta 40 cm	1345N	207	+21
Lateral fijo a medida OPEN BLACK de 40 hasta 80 cm	1316N	282	+21
Lateral fijo a medida OPEN BLACK de 80 hasta 120 cm	1317N	352	+21

\*Plazo de entrega 15 días.



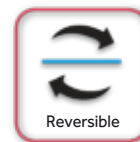

### COMBI C + LATERAL FIJO 70 C/BRAZO 9017

Medidas (F+A) xLF	Rango	Referencia	Puntos
80 (30+50) x70	77-79,5/66-69	9000+9004+9018+9017	597
85 (30+55) x70	82-84,5/66-69	9000+9005+9018+9017	606
90 (40+50) x70	87-89,5/66-69	9001+9004+9018+9017	613
95 (30+65) x70	92-94,5/66-69	9000+9007+9018+9017	619
100 (30+70) x70	97-99,5/66-69	9000+9008+9018+9017	629
100 (50+50) x70	97-99,5/66-69	9002+9004+9018+9017	629
105 (40+65) x70	102-104,5/66-69	9001+9007+9018+9017	635
110 (30+80) x70	107-109,5/66-69	9000+9010+9018+9017	649
110 (40+70) x70	107-109,5/66-69	9001+9008+9018+9017	645
110 (60+50) x70	107-109,5/66-69	9003+9004+9018+9017	644
115 (50+65) x70	112-114,5/66-69	9002+9007+9018+9017	651
120 (40+80) x70	117-119,5/66-69	9001+9010+9018+9017	665
120 (50+70) x70	117-119,5/66-69	9002+9008+9018+9017	661
125 (60+65) x70	122-124,5/66-69	9003+9007+9018+9017	666
130 (50+80) x70	127-129,5/66-69	9002+9010+9018+9017	681
130 (60+70) x70	127-129,5/66-69	9003+9008+9018+9017	676
135 (60+75) x70	132-134,5/66-69	9003+9009+9018+9017	691
140 (60+80) x70	137-139,5/66-69	9003+9010+9018+9017	696
145 (60+85) x70	142-144,5/66-69	9003+9011+9018+9017	706

Apertura exterior 90° p/fijo



Opción in-out 0180° p/fijo



El rango del frontal aumenta 1,4 cm y el rango del lateral fijo se reduce 1 cm  
Ref. 0038 - Incremento 21 puntos



Opción barra 140 cm más soporte lateral fijo-Ref. 9026+9028  
Incremento 38 puntos (ya descontado brazo 9017)

### COMBI C + LATERAL FIJO 80 C/BRAZO 9017

Medidas (F+A) xLF	Rango	Referencia	Puntos
80 (30+50) x80	77-79,5/76-79	9000+9004+9019+9017	607
85 (30+55) x80	82-84,5/76-79	9000+9005+9019+9017	616
90 (40+50) x80	87-89,5/76-79	9001+9004+9019+9017	623
95 (30+65) x80	92-94,5/76-79	9000+9007+9019+9017	629
100 (30+70) x80	97-99,5/76-79	9000+9008+9019+9017	639
100 (50+50) x80	97-99,5/76-79	9002+9004+9019+9017	639
105 (40+65) x80	102-104,5/76-79	9001+9007+9019+9017	645
110 (30+80) x80	107-109,5/76-79	9000+9010+9019+9017	659
110 (40+70) x80	107-109,5/76-79	9001+9008+9019+9017	655
110 (60+50) x80	107-109,5/76-79	9003+9004+9019+9017	654
115 (50+65) x80	112-114,5/76-79	9002+9007+9019+9017	661
120 (40+80) x80	117-119,5/76-79	9001+9010+9019+9017	675
120 (50+70) x80	117-119,5/76-79	9002+9008+9019+9017	671
125 (60+65) x80	122-124,5/76-79	9003+9007+9019+9017	676
130 (50+80) x80	127-129,5/76-79	9002+9010+9019+9017	691
130 (60+70) x80	127-129,5/76-79	9003+9008+9019+9017	686
135 (60+75) x80	132-134,5/76-79	9003+9009+9019+9017	701
140 (60+80) x80	137-139,5/76-79	9003+9010+9019+9017	706
145 (60+85) x80	142-144,5/76-79	9003+9011+9019+9017	716

### COMBI C + LATERAL FIJO 90 C/BRAZO 9017

Medidas (F+A) xLF	Rango	Referencia	Puntos
80 (30+50) x90	77-79,5/86-89	9000+9004+9020+9017	617
85 (30+55) x90	82-84,5/86-89	9000+9005+9020+9017	626
90 (40+50) x90	87-89,5/86-89	9001+9004+9020+9017	633
95 (30+65) x90	92-94,5/86-89	9000+9007+9020+9017	639
100 (30+70) x90	97-99,5/86-89	9000+9008+9020+9017	649
100 (50+50) x90	97-99,5/86-89	9002+9004+9020+9017	649
105 (40+65) x90	102-104,5/86-89	9001+9007+9020+9017	655
110 (30+80) x90	107-109,5/86-89	9000+9010+9020+9017	669
110 (40+70) x90	107-109,5/86-89	9001+9008+9020+9017	665
110 (60+50) x90	107-109,5/86-89	9003+9004+9020+9017	664
115 (50+65) x90	112-114,5/86-89	9002+9007+9020+9017	671
120 (40+80) x90	117-119,5/86-89	9001+9010+9020+9017	685
120 (50+70) x90	117-119,5/86-89	9002+9008+9020+9017	681
125 (60+65) x90	122-124,5/86-89	9003+9007+9020+9017	686
130 (50+80) x90	127-129,5/86-89	9002+9010+9020+9017	701
130 (60+70) x90	127-129,5/86-89	9003+9008+9020+9017	696
135 (60+75) x90	132-134,5/86-89	9003+9009+9020+9017	711
140 (60+80) x90	137-139,5/86-89	9003+9010+9020+9017	716
145 (60+85) x90	142-144,5/86-89	9003+9011+9020+9017	726

# OPEN BLACK COMBI D fijo + puerta abatible cierre perfil imán



## COMBI D

FIJOS	Rango cm	Ref.	Puntos
FIJO 30	27,5/30	9000	146
FIJO 40	37,5/40	9001	162
FIJO 50	47,5/50	9002	178
FIJO 60	57,5/60	9003	193
(2,5 ajuste)			
Cierre perfil imán ref. 9013			70

PUERTAS	Rango cm	Ref.	Puntos
PUERTA 50	50	9004+9013	325
PUERTA 55	55	9005+9013	334
PUERTA 60	60	9006+9013	342
PUERTA 65	65	9007+9013	347
PUERTA 70	70	9008+9013	357
PUERTA 75	75	9009+9013	372
PUERTA 80	80	9010+9013	377
PUERTA 85	85	9011+9013	387

(2,5 ajuste)



Paneles fijos a medida (ver pág. 281)

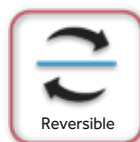

## COMBI D

Combinación con puertas de 50, 55, 65, 70, 80 y 85

Medidas	Rango	Fijo	Puerta	Apertura	Referencia	Puntos
80	80-85	30	50	43	9000+9004+9013	471
85	85-90	30	55	48	9000+9005+9013	480
90	90-95	40	50	43	9001+9004+9013	487
95	95-100	30	65	58	9000+9007+9013	493
100	100-105	30	70	63	9000+9008+9013	503
100	100-105	50	50	43	9002+9004+9013	503
105	105-110	40	65	58	9001+9007+9013	509
110	110-115	30	80	73	9000+9010+9013	523
110	110-115	40	70	63	9001+9008+9013	519
110	110-115	60	50	43	9003+9004+9013	518
115	115-120	50	65	58	9002+9007+9013	525
120	120-125	40	80	73	9001+9010+9013	539
120	120-125	50	70	63	9002+9008+9013	535
125	125-130	60	65	58	9003+9007+9013	540
130	130-135	50	80	73	9002+9010+9013	555
130	130-135	60	70	63	9003+9008+9013	550
135	135-140	60	75	68	9003+9009+9013	565
140	140-145	60	80	73	9003+9010+9013	570
145	145-150	60	85	78	9003+9011+9013	580

\*Permite uso perfil compensación en ambos lados

\*Opción con lateral fijo, consultar fábrica.

Descripción	Referencia	Puntos
Perfil compensación lado fijo +3 cm	9016	29
Juego gomas imán expansión +1,2 cm	1221	24
Juego gomas apertura IN-OUT 180°	1213	38



Opción barra 140 cm Ref. 9026. Incremento 60 puntos.

# OPEN BLACK COMBI E fijo + puerta abatible con cierre a fijo



## COMBI E

FIJOS	Rango cm	Ref.	Puntos
FIJO 30	27,5/30	9000	146
FIJO 40	37,5/40	9001	162
FIJO 50	47,5/50	9002	178
FIJO 60	57,5/60	9003	193
(2,5 ajuste)			
Perfil pared Open Black ref. 9012			25



Paneles fijos a medida (ver pág. 281)

PUERTAS	Rango cm	Ref.	Puntos
PUERTA 50	50	9004+9012	280
PUERTA 55	55	9005+9012	289
PUERTA 60	60	9006+9012	297
PUERTA 65	65	9007+9012	302
PUERTA 70	70	9008+9012	312
PUERTA 75	75	9009+9012	327
PUERTA 80	80	9010+9012	332
PUERTA 85	85	9011+9012	342

(1,5 ajuste)

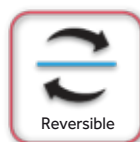

## COMBI E

Combinación con puertas de 50, 55, 65, 70, 80 y 85

Medidas	Rango	Fijo	Puerta	Apertura	Referencia	Puntos
80	78,6-82,6	30	50	43	9000+9004+9012	426
85	83,6-87,6	30	55	48	9000+9005+9012	435
90	88,6-92,6	40	50	43	9001+9004+9012	442
95	93,6-97,6	30	65	58	9000+9007+9012	448
100	98,6-102,6	30	70	63	9000+9008+9012	458
100	98,6-102,6	50	50	43	9002+9004+9012	458
105	103,6-107,6	40	65	58	9001+9007+9012	464
110	108,6-112,6	30	80	73	9000+9010+9012	478
110	108,6-112,6	40	70	63	9001+9008+9012	474
110	108,6-112,6	60	50	43	9003+9004+9012	473
115	113,6-117,6	50	65	58	9002+9007+9012	480
120	118,6-122,6	40	80	73	9001+9010+9012	494
120	118,6-122,6	50	70	63	9002+9008+9012	490
125	123,6-127,6	60	65	58	9003+9007+9012	495
130	128,6-132,6	50	80	73	9002+9010+9012	510
130	128,6-132,6	60	70	63	9003+9008+9012	505
135	133,6-137,6	60	75	68	9003+9009+9012	520
140	138,6-142,6	60	80	73	9003+9010+9012	525
145	143,6-147,6	60	85	78	9003+9011+9012	535

\*Opción con lateral fijo, consultar fábrica.

Descripción	Ref.	Puntos
Perfil compensación lado fijo +3 cm	9016	29
Perfil puerta (reduce hasta 1 cm el rango)	9014	25
Juego gomas imán expansión +1,2 cm	1221	24
Perfil expansor puerta +2,5 cm	9015	48
Juego gomas apertura IN-OUT 180°	1213	38

# OPEN BLACK COMBI F 2 fijos + puerta abatible con cierre a fijo



## COMBI F

FIJOS	Rango cm	Ref.	Puntos
FIJO 30	27,5/30	9000	146
FIJO 40	37,5/40	9001	162
FIJO 50	47,5/50	9002	178
FIJO 60	57,5/60	9003	193

ajuste 2,5x2 = 5 cm



Paneles fijos a medida (ver pág. 281)

PUERTAS	Rango cm	Ref.	Puntos
PUERTA 50	50	9004	255
PUERTA 55	55	9005	264
PUERTA 60	60	9006	272
PUERTA 65	65	9007	277
PUERTA 70	70	9008	287
PUERTA 75	75	9009	302
PUERTA 80	80	9010	307
PUERTA 85	85	9011	317





H195

Altura



6mm

Grosor cristal



Abatible 90°



Magnético



2.5 cm

Expansión

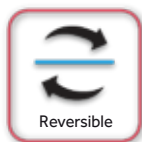

Reversible



aluminio  
AL  
aluminium



tratamiento  
antical  
clear  
shield  
glass

## COMBI F

Combinación con puertas de 50, 55, 65, 70, 80 y 85

Medidas (F+P+F)	Rango	Ap.	Referencia	Puntos	Medidas (F+P+F)	Rango	Ap.	Referencia	Puntos
110 (30+50+30)	105-110	43	9000+9004+9000	547	160 (40+70+50)	155-160	63	9001+9008+9002	627
115 (30+55+30)	110-115	48	9000+9005+9000	556	160 (30+80+50)	155-160	73	9000+9010+9002	631
120 (30+50+40)	115-120	43	9000+9004+9001	563	160 (40+80+40)	155-160	73	9001+9010+9001	631
125 (30+65+30)	120-125	58	9000+9007+9000	569	165 (40+65+60)	160-165	58	9001+9007+9003	632
130 (30+70+30)	125-130	63	9000+9008+9000	579	165 (50+65+50)	160-165	58	9002+9007+9002	633
135 (30+65+40)	130-135	58	9000+9007+9001	585	170 (60+50+60)	165-170	43	9003+9004+9003	641
140 (30+70+40)	135-140	63	9000+9008+9001	595	170 (40+70+60)	165-170	63	9001+9008+9003	642
140 (30+80+30)	135-140	73	9000+9010+9000	599	170 (50+70+50)	165-170	63	9002+9008+9002	643
140 (30+50+60)	135-140	43	9000+9004+9003	594	170 (30+80+60)	165-170	73	9000+9010+9003	646
145 (30+65+50)	140-145	58	9000+9007+9002	601	170 (40+80+50)	165-170	73	9001+9010+9002	647
145 (40+65+40)	140-145	58	9001+9007+9001	601	175 (50+65+60)	170-175	58	9002+9007+9003	648
150 (40+50+60)	145-150	43	9001+9004+9003	610	180 (50+70+60)	175-180	63	9002+9008+9003	658
150 (30+70+50)	145-150	63	9000+9008+9002	611	180 (40+80+60)	175-180	73	9001+9010+9003	662
150 (40+70+40)	145-150	63	9001+9008+9001	611	180 (50+80+50)	175-180	73	9002+9010+9002	663
150 (30+80+40)	145-150	73	9000+9010+9001	615	185 (60+65+60)	180-185	58	9003+9007+9003	663
155 (30+65+60)	150-155	58	9000+9007+9003	616	190 (60+70+60)	185-190	63	9003+9008+9003	673
155 (40+65+50)	150-155	58	9001+9007+9002	617	190 (50+80+60)	185-190	73	9002+9010+9003	678
160 (50+50+60)	155-160	43	9002+9004+9003	626	195 (60+75+60)	190-195	68	9003+9009+9003	688
160 (30+70+60)	155-160	63	9000+9008+9003	626	200 (60+80+60)	195-200	73	9003+9010+9003	693

\*Opción con lateral fijo, consultar fábrica.

Descripción	Ref.	Puntos
Perfil compensación lado fijo +3 cm	9016	29
Juego gomas imán expansión +1,2 cm	1221	24
Juego gomas apertura IN-OUT 180°	1213	38



Opción barra 140 cm, ref. 9026 + 60 puntos  
Opción barra 200 cm, ref. 9027 + 80 puntos



# OPEN BLACK COMBI G fijo + 2 puertas abatibles + fijo



Opción barra 200 más soportes Ref. 9027. Incremento 80 puntos

## COMBI G

FIJOS	Rango cm	Ref.	Puntos
FIJO 30	27,5/30	9000	146
FIJO 40	37,5/40	9001	162
FIJO 50	47,5/50	9002	178
FIJO 60	57,5/60	9003	193

ajuste 2,5x2 = 5 cm



Paneles fijos a medida (ver pág. 281)

PUERTAS	Rango cm	Ref.	Puntos
PUERTA 50	50	9004	255
PUERTA 55	55	9005	264
PUERTA 60	60	9006	272
PUERTA 65	65	9007	277
PUERTA 70	70	9008	287
PUERTA 75	75	9009	302
PUERTA 80	80	9010	307
PUERTA 85	85	9011	317

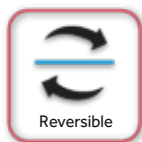

## COMBI G

Combinación con puertas 50, 65, 70 y 80

Medidas (F+P+P+F)	Rango	Referencia	Puntos
155 (30+50+50+30)	151,2-156,2	9000x2+9004x2	802
165 (30+50+50+40)	161,2-166,2	9000+9001+9004x2	818
175 (30+50+50+50)	171,2-176,2	9000+9002+9004x2	834
175 (40+50+50+40)	171,2-176,2	9001x2+9004x2	834
185 (40+50+50+50)	181,2-186,2	9001+9002+9004x2	850
185 (30+50+50+60)	181,2-186,2	9000+9003+9004x2	849
185 (30+65+65+30)	181,2-186,2	9000x2+9007x2	846
195 (50+50+50+50)	191,2-196,2	9002x2+9004x2	866
195 (40+50+50+60)	191,2-196,2	9001+9003+9004x2	865
195 (30+65+65+40)	191,2-196,2	9000+9001+9007x2	862
195 (30+70+70+30)	191,2-196,2	9000x2+9008x2	866
205 (40+65+65+40)	201,2-206,2	9001x2+9007x2	878
205(30+65+65+50)	201,2-206,2	9000+9002+9007x2	878
205 (30+70+70+40)	201,2-206,2	9000+9001+9008x2	882
205 (50+50+50+60)	201,2-206,2	9002+9003+9004x2	881
215 (30+65+65+60)	211,2-216,2	9000+9003+9007x2	893
215 (40+65+65+50)	211,2-216,2	9001+9002+9007x2	894
215 (30+70+70+50)	211,2-216,2	9000+9002+9008x2	898
215 (40+70+70+40)	211,2-216,2	9001x2+9008x2	898
215 (30+80+80+30)	211,2-216,2	9000x2+9010x2	906

\*Opción con lateral fijo, consultar fábrica.

## COMBI G

Combinación con puertas 50, 65, 70 y 80

Medidas (F+P+P+F)	Rango	Referencia	Puntos
215 (60+50+50+60)	211,2-216,2	9003x2+9004x2	896
225 (50+65+65+50)	221,2-226,2	9002x2+9007x2	910
225 (40+65+65+60)	221,2-226,2	9001+9003+9007x2	909
225 (30+70+70+60)	221,2-226,2	9000+9003+9008x2	913
225 (40+70+70+50)	221,2-226,2	9001+9002+9008x2	914
225 (30+80+80+40)	221,2-226,2	9000+9001+9010x2	922
235 (50+65+65+60)	231,2-236,2	9002+9003+9007x2	925
235 (40+70+70+60)	231,2-236,2	9001+9003+9008x2	929
235 (50+70+70+50)	231,2-236,2	9002x2+9008x2	930
235 (40+80+80+40)	231,2-236,2	9001x2+9010x2	938
245 (60+65+65+60)	241,2-246,2	9003x2+9007x2	940
245 (50+70+70+60)	241,2-246,2	9002+9003+9008x2	945
245 (30+80+80+60)	241,2-246,2	9000+9003+9010x2	953
245 (40+80+80+50)	241,2-246,2	9001+9002+9010x2	954
255 (60+70+70+60)	251,2-256,2	9003x2+9008x2	960
255 (40+80+80+60)	251,2-256,2	9001+9003+9010x2	969
255 (50+80+80+50)	251,2-256,2	9002x2+9010x2	970
265 (50+80+80+60)	261,2-266,2	9002+9003+9010x2	985
275 (60+80+80+60)	271,2-276,2	9003x2+9010x2	1000

Descripción	Ref.	Puntos
Perfil compensación lado fijo +3 cm	9016	29
Juego gomas imán expansión +1,2 cm	1221	24



Opción barra 200 más soportes Ref. 9027. Incremento 80 puntos

# OPEN BLACK COMBI H angular 2 puertas abatibles + 2 fijos



## COMBI H

FIJOS	Rango cm	Ref.	Puntos
FIJO 30	27,5/30	9000	146
FIJO 40	37,5/40	9001	162
FIJO 50	47,5/50	9002	178
FIJO 60	57,5/60	9003	193

(ajuste 2,5 cm)



Paneles fijos a medida (ver pág. 281)

PUERTAS	Rango cm	Ref.	Puntos
PUERTA 50	50	9004	255
PUERTA 55	55	9005	264
PUERTA 60	60	9006	272
PUERTA 65	65	9007	277
PUERTA 70	70	9008	287
PUERTA 75	75	9009	302
PUERTA 80	80	9010	307
PUERTA 85	85	9011	317

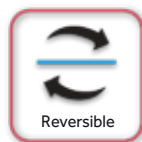

## COMBI H

Combinación con puertas 50, 65, 70 y 80

Medidas (F+P+P+F)	Rango	Referencia	Puntos
80X80(30+50+50+30)	77-79,5 / 77-79,5	9000x2+ 9004x2	802
90x90(40+50+50+40)	87-89,5 / 87-89,5	9001x2+9004x2	834
95x95(30+65+65+30)	92-94,5 / 92-94,5	9000x2+9007x2	846
100x100(30+70+70+30)	97-99,5 / 97-99,5	9000x2+9008x2	866
100x100(50+50+50+50)	97-99,5 / 97-99,5	9002x2+9004x2	866
90x80(40+50+50+30)	87-89,5 / 77-79,5	9001+9000+9004x2	818
95x80(30+65+50+30)	92-94,5 / 77-79,5	9000+9007+9000+9004	824
100x80(30+70+50+30)	97-99,5 / 77-79,5	9000+9008+9000+9004	834
105x80(40+65+50+30)	102-104,5 / 77-79,5	9001+9007+9000+9004	840
110x80(60+50+50+30)	107-109,5 / 77-79,5	9003+9004+9000+9004	849
110x80(40+70+50+30)	107-109,5 / 77-79,5	9001+9008+9000+9004	850
110x80(30+80+50+30)	107-109,5 / 77-79,5	9000x2+9010+9004	854
115x80(50+65+50+30)	112-114,5 / 77-79,5	9002+9007+9000+9004	856
120x80(50+70+50+30)	117-119,5 / 77-79,5	9002+9008+9000+9004	866
120x80(40+80+50+30)	117-119,5 / 77-79,5	9001+9010+9000+9004	870
125x80(60+65+50+30)	122-124,5 / 77-79,5	9003+9007+9000+9004	871
130x80(50+80+50+30)	127-129,5 / 77-79,5	9002+9010+9000+9004	886
130x80(60+70+50+30)	127-129,5 / 77-79,5	9003+9008+9000+9004	881
140x80(60+80+50+30)	137-139,5 / 77-79,5	9003+9010+9000+9004	901
95x90(30+65+50+40)	92-94,5 / 87-89,5	9000+9007+9001+9004	840
100x90(30+70+50+40)	97-99,5 / 87-89,5	9000+9008+9001+9004	850
105x90(40+65+50+40)	102-104,5 / 87-89,5	9001x2+9007+9004	856
110x90(60+50+50+40)	107-109,5 / 87-89,5	9003+9001+9004x2	865
110x90(40+70+50+40)	107-109,5 / 87-89,5	9001x2+9008+9004	866
110x90(30+80+50+40)	107-109,5 / 87-89,5	9000+9010+9001+9004	870
115x90(50+65+50+40)	112-114,5 / 87-89,5	9002+9007+9001+9004	872
120x90(50+70+50+40)	117-119,5 / 87-89,5	9002+9008+9001+9004	882
120x90(40+80+50+40)	117-119,5 / 87-89,5	9001x2+9010+9004	886
125x90(60+65+50+40)	122-124,5 / 87-89,5	9003+9007+9001+9004	887
130x90(60+70+50+40)	127-129,5 / 87-89,5	9003+9008+9001+9004	897
130x90(50+80+50+40)	127-129,5 / 87-89,5	9002+9010+9001+9004	902
140x90(60+80+50+40)	137-139,5 / 87-89,5	9003+9010+9001+9004	917

Descripción	Ref.	Puntos
Perfil compensación lado fijo +3 cm	9016	29

OPEN BLACK COMBI I 2 puertas abatibles







H195

Altura



6mm

Grosor cristal



Opción 180°



Magnético



1.5 cm

Expansión

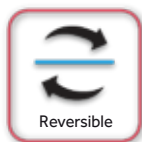

Reversible



aluminio  
AL  
aluminium



tratamiento antical  
clear shield glass

## COMBI | Combinación con puertas de 50, 55, 65, 70, 80 y 85

Medidas (P+P)	Rango	Apert.	Referencias	Puntos
100 (50+50)	99-102	86	9004x2+9012X2	560
105 (50+55)	104-107	91	9004+9005+9012X2	569
110 (55+55)	109-112	96	9005x2+9012x2	578
115 (55+60)	114-117	101	9005+9006+9012x2	586
120 (60+60)	119-122	106	9006+9006+9012x2	594
125 (60+65)	124-127	111	9006+9007+9012x2	599
130 (65+65)	129-132	116	9007x2+9012x2	604
135 (65+70)	134-137	121	9007+9008+9012x2	614
140 (70+70)	139-142	126	9008x2+9012x2	624
145 (70+75)	144-147	131	9008+9009+9012x2	639
150 (75+75)	149-152	136	9009x2+9012x2	654
155 (75+80)	154-157	141	9009+9010+9012x2	659
160 (80+80)	159-162	146	9010x2+9012x2	664
165 (80+85)	164-167	151	9010+9011+9012x2	674
170 (85+85)	169-172	156	9011x2+9012x2	684

\*Opción con lateral fijo, consultar fábrica.

Descripción	Ref.	Puntos
Juego gomas imán expansión +1,2 cm	1221	24
Perfil expansor puerta +2,5 cm	9015	48
Perfil puerta (reduce hasta 1 cm el rango)	9014	25

# OPEN BLACK COMBI J 1 fijo + 2 puertas abatibles



## COMBI J

FIJOS	Rango cm	Ref.	Puntos
FIJO 30	27,5/30	9000	146
FIJO 40	37,5/40	9001	162
FIJO 50	47,5/50	9002	178
FIJO 60	57,5/60	9003	193
(2,5 ajuste)			
Perfil pared Open Black ref. 9012			25



Paneles fijos a medida (ver pág. 281)

PUERTAS	Rango cm	Ref.	Puntos
PUERTA 50	50	9004	255
PUERTA 55	55	9005	264
PUERTA 60	60	9006	272
PUERTA 65	65	9007	277
PUERTA 70	70	9008	287
PUERTA 75	75	9009	302
PUERTA 80	80	9010	307
PUERTA 85	85	9011	317

(1,5 ajuste)

**H195**

Altura

**6mm**

Grosor cristal



Opción 180°



Magnético

**25/15cm**

Expansión

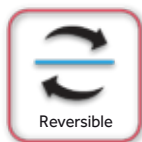

Reversible

aluminio  
**AL**  
aluminiumtratamiento  
antical  
clear  
shield  
glass

## COMBI J Combinación con puertas de 50, 55, 65, 70, 75 y 80

Medidas (P+P+F)	Rango	Apertura	Referencias	Puntos
125 (50+50+30)	124,8/128,8	86	9004x2+9000+9012	681
130 (50+55+30)	129,8/133,8	91	9004+9005+9000+9012	690
135 (50+50+40)	134,8/138,8	86	9004x2+9001+9012	697
140 (60+55+30)	139,8/143,8	101	9006+9005+9000+9012	707
145 (50+50+50)	144,8/148,8	86	9004x2+9002+9012	713
150 (60+60+30)	149,8/153,8	106	9006x2+9000+9012	715
155 (55+55+50)	154,8/158,8	96	9005x2+9002+9012	731
160 (60+55+50)	159,8/163,8	101	9006+9005+9002+9012	739
165 (65+65+40)	164,8/168,8	116	9007x2+9001+9012	741
170 (75+70+30)	169,8/173,8	121	9009+9008+9000+9012	760
175 (75+75+30)	174,8/178,8	136	9009x2+9000+9012	775
180 (80+75+30)	179,8/183,8	141	9010+9009+9000+9012	780
185 (80+80+30)	184,8/188,8	146	9010x2+9000+9012	785
190 (65+70+60)	189,8/193,8	121	9007+9008+9003+9012	782
195 (75+75+50)	194,8/198,8	136	9009x2+9002+9012	807
200 (75+80+50)	199,8/203,8	131	9009+9010+9002+9012	812
205 (80+80+50)	204,8/208,8	146	9010x2+9002+9012	817
210 (80+75+60)	209,8/213,8	141	9009+9010+9003+9012	827
215 (80+80+60)	214,8/218,8	146	9010x2+9003+9012	832

\*Opción con lateral fijo, consultar fábrica.

Descripción	Ref.	Puntos
Perfil compensación lado fijo +3 cm	9016	29
Perfil puerta (reduce hasta 1 cm el rango)	9014	25
Juego gomas imán expansión +1,2 cm	1221	24
Perfil expansor puerta +2,5 cm	9015	48



Opción barra 140 cm, ref. 9026 + 60 puntos  
Opción barra 200 cm, ref. 9027 + 80 puntos



# glass

"Soluciones a cualquier espacio con la elegancia de la aperturas abatible con bisagra"







GLASS

# GLASS fijo + puerta abatible con cierre imán a pared



Opción barra 140 cm Ref. 1716  
Incremento 60 puntos

## COMBI C

FIJOS	Rango	Ref.	Puntos
FIJO 20	17/20	1700	267
FIJO 25	22/25	1701	276
FIJO 30	27/30	1702	285
FIJO 40	37/40	1703	302
FIJO 50	47/50	1704	319
FIJO 60	57/60	1705	335

(3 cm ajuste)

PUERTAS	Medida	Ref.	Puntos
PUERTA 30	30	1725	52
PUERTA 35	35	1727	58
PUERTA 40	40	1726	64
PUERTA 45	45	1728	70
PUERTA 50	50	1706	76
PUERTA 65	65	1707	96
PUERTA 70	70	1708	101
PUERTA 80	80	1709	113

(sin ajuste)



Paneles fijos y puertas a medida ver pág. 281





H195

Altura



8/6mm

Grosor cristal



Abatible 90°



Magnético



3cm

Expansión

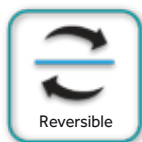

Reversible



aluminio  
AL  
aluminium



tratamiento antical  
clear shield glass

## COMBI C

Combinación con puertas 50, 65, 70 y 80

Medidas	Fijo	Puerta	Apertura	Rango	Referencia	Puntos
70	20	50	47	67-70	1700+1706	343
75	25	50	47	72-74	1701+1706	352
80	30	50	47	77-80	1702+1706	361
85	20	65	62	82-85	1700+1707	363
90	25	65	62	87-90	1701+1707	372
90	20	70	67	87-90	1700+1708	368
90	40	50	47	87-90	1703+1706	378
95	25	70	67	92-95	1701+1708	377
95	30	65	62	92-95	1702+1707	381
100	30	70	67	97-100	1702+1708	386
100	50	50	47	97-100	1704+1706	395
100	20	80	77	97-100	1700+1709	380
105	25	80	77	102-105	1701+1709	389
105	40	65	62	102-105	1703+1707	398
110	30	80	77	107-110	1702+1709	398
110	40	70	67	107-110	1703+1708	403
110	60	50	47	107-110	1705+1706	411
115	50	65	62	112-115	1704+1707	415
120	40	80	77	117-120	1703+1709	415
120	50	70	67	117-120	1704+1708	420
125	60	65	62	122-125	1705+1707	431
130	50	80	77	127-130	1704+1709	432
130	60	70	67	127-130	1705+1708	436
140	60	80	77	137-140	1705+1709	448

\*Permite combinación con Lateral fijo STD en lado fijo, rango mínimo +0,7 (sin ajuste), ver pág. 202.

\*Permite combinación con lateral fijo Glass en lado puerta, el rango del frontal se reducirá en 0,5 cm. Expansión 3 cm.

Descripción	Referencias	Puntos
Perfil compensación +2 cm lado fijo	0218	25
Perfil compensación +4 cm lado fijo	0029	35
Imán expansión +1,2 cm (ver pág. 285)	1221	24



# GLASS COMBI C + lat. fijo



## Laterales fijos GLASS 6 mm

Descripción	Rango	Ref.	Puntos
Lateral fijo 70x195	66-69	1720	155
Lateral fijo 80x195	76-79	1721	166
Lateral fijo 90x195	86-89	1722	178
Brazo orientable		1715	34

Descripción	Referencia	Puntos
Perfil compensación +2 cm	0218	25
Perfil compensación +4 cm	0029	35
Perfil compensación +5,5 cm	0219	35



## Laterales fijos a medida 6 mm (más información en página 282)

Descripción	Referencia	Puntos	Cajonado
Lateral fijo a medida OPEN/GLASS hasta 40 cm	1345	175	+21
Lateral fijo a medida OPEN/GLASS de 40 hasta 80 cm	1316	250	+21
Lateral fijo a medida OPEN/GLASS de 80 hasta 120 cm	1317	320	+21

\*Plazo de entrega 15 días

## COMBI C + LATERAL FIJO 70 c/BRAZO 1715

Medidas (F+A)xLF	Rango	Referencia	Ptos.
70 (20+50) x70	66,5-69,5/66-69	1700+1706+1720+1715	532
75 (25+50) x70	71,5-74,5/66-69	1701+1706+1720+1715	541
80 (30+50) x70	76,5-79,5/66-69	1702+1706+1720+1715	550
85 (20+65) x70	81,5-84,5/66-69	1700+1707+1720+1715	552
90 (25+65) x70	86,5-89,5/66-69	1701+1707+1720+1715	561
90 (20+70) x70	86,5-89,5/66-69	1700+1708+1720+1715	557
90 (40+50) x70	86,5-89,5/66-69	1703+1706+1720+1715	567
95 (25+70) x70	91,5-94,5/66-69	1701+1708+1720+1715	566
95 (30+65) x70	91,5-94,5/66-69	1702+1707+1720+1715	570
100 (30+70) x70	96,5-99,5/66-69	1702+1708+1720+1715	575
100 (50+50) x70	96,5-99,5/66-69	1704+1706+1720+1715	584
100 (20+80) x70	96,5-99,5/66-69	1700+1709+1720+1715	569
105 (25+80) x70	101,5-104,5/66-69	1701+1709+1720+1715	578
105 (40+65) x70	101,5-104,5/66-69	1703+1707+1720+1715	587
110 (30+80) x70	106,5-109,5/66-69	1702+1709+1720+1715	587
110 (40+70) x70	106,5-109,5/66-69	1703+1708+1720+1715	592
110 (60+50) x70	106,5-109,5/66-69	1705+1706+1720+1715	600
115 (50+65) x70	111,5-114,5/66-69	1704+1707+1720+1715	604
120 (40+80) x70	116,5-119,5/66-69	1703+1709+1720+1715	604
120 (50+70) x70	116,5-119,5/66-69	1704+1708+1720+1715	609
125 (60+65) x70	121,5-124,5/66-69	1705+1707+1720+1715	620
130 (50+80) x70	126,5-129,5/66-69	1704+1709+1720+1715	621
130 (60+70) x70	126,5-129,5/66-69	1705+1708+1720+1715	625
140 (60+80) x70	136,5-139,5/66-69	1705+1709+1720+1715	637

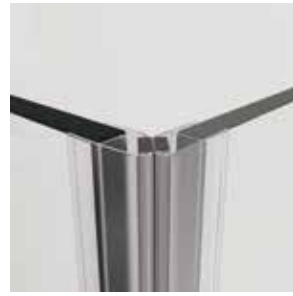

Cierre imán-imán  
Apertura exterior  
90° p/fijo



Opción barra 140 cm más soporte lateral fijo-Ref. 1716+1718  
Incremento 42 puntos (ya descontado brazo 1715)

## COMBI C + LATERAL FIJO 80 c/BRAZO 1715

Medidas (F+A)xLF	Rango	Referencia	Ptos.
70 (20+50) x80	66,5-69,5/76-79	1700+1706+1721+1715	543
75 (25+50) x80	71,5-74,5/76-79	1701+1706+1721+1715	552
80 (30+50) x80	76,5-79,5/76-79	1702+1706+1721+1715	561
85 (20+65) x80	81,5-84,5/76-79	1700+1707+1721+1715	563
90 (25+65) x80	86,5-89,5/76-79	1701+1707+1721+1715	572
90 (20+70) x80	86,5-89,5/76-79	1700+1708+1721+1715	568
90 (40+50) x80	86,5-89,5/76-79	1703+1706+1721+1715	578
95 (25+70) x80	91,5-94,5/76-79	1701+1708+1721+1715	577
95 (30+65) x80	91,5-94,5/76-79	1702+1707+1721+1715	581
100 (30+70) x80	96,5-99,5/76-79	1702+1708+1721+1715	586
100 (50+50) x80	96,5-99,5/76-79	1704+1706+1721+1715	595
100 (20+80) x80	96,5-99,5/76-79	1700+1709+1721+1715	580
105 (25+80) x80	101,5-104,5/76-79	1701+1709+1721+1715	589
105 (40+65) x80	101,5-104,5/76-79	1703+1707+1721+1715	598
110 (30+80) x80	106,5-109,5/76-79	1702+1709+1721+1715	598
110 (40+70) x80	106,5-109,5/76-79	1703+1708+1721+1715	603
110 (60+50) x80	106,5-109,5/76-79	1705+1706+1721+1715	611
115 (50+65) x80	111,5-114,5/76-79	1704+1707+1721+1715	615
120 (40+80) x80	116,5-119,5/76-79	1703+1709+1721+1715	615
120 (50+70) x80	116,5-119,5/76-79	1704+1708+1721+1715	620
125 (60+65) x80	121,5-124,5/76-79	1705+1707+1721+1715	631
130 (50+80) x80	126,5-129,5/76-79	1704+1709+1721+1715	632
130 (60+70) x80	126,5-129,5/76-79	1705+1708+1721+1715	636
140 (60+80) x80	136,5-139,5/76-79	1705+1709+1721+1715	648

## COMBI C + LATERAL FIJO 90 c/BRAZO 1715

Medidas (F+A)xLF	Rango	Referencia	Ptos.
70 (20+50) x90	66,5-69,5/86-89	1700+1706+1722+1715	555
75 (25+50) x90	71,5-74,5/86-89	1701+1706+1722+1715	564
80 (30+50) x90	76,5-79,5/86-89	1702+1706+1722+1715	573
85 (20+65) x90	81,5-84,5/86-89	1700+1707+1722+1715	575
90 (25+65) x90	86,5-89,5/86-89	1701+1707+1722+1715	584
90 (20+70) x90	86,5-89,5/86-89	1700+1708+1722+1715	580
90 (40+50) x90	86,5-89,5/86-89	1703+1706+1722+1715	590
95 (25+70) x90	91,5-94,5/86-89	1701+1708+1722+1715	589
95 (30+65) x90	91,5-94,5/86-89	1702+1707+1722+1715	593
100 (30+70) x90	96,5-99,5/86-89	1702+1708+1722+1715	598
100 (50+50) x90	96,5-99,5/86-89	1704+1706+1722+1715	607
100 (20+80) x90	96,5-99,5/86-89	1700+1709+1722+1715	592
105 (25+80) x90	101,5-104,5/86-89	1701+1709+1722+1715	601
105 (40+65) x90	101,5-104,5/86-89	1703+1707+1722+1715	610
110 (30+80) x90	106,5-109,5/86-89	1702+1709+1722+1715	610
110 (40+70) x90	106,5-109,5/86-89	1703+1708+1722+1715	615
110 (60+50) x90	106,5-109,5/86-89	1705+1706+1722+1715	623
115 (50+65) x90	111,5-114,5/86-89	1704+1707+1722+1715	627
120 (40+80) x90	116,5-119,5/86-89	1703+1709+1722+1715	627
120 (50+70) x90	116,5-119,5/86-89	1704+1708+1722+1715	632
125 (60+65) x90	121,5-124,5/86-89	1705+1707+1722+1715	643
130 (50+80) x90	126,5-129,5/86-89	1704+1709+1722+1715	644
130 (60+70) x90	126,5-129,5/86-89	1705+1708+1722+1715	648
140 (60+80) x90	136,5-139,5/86-89	1705+1709+1722+1715	660

# GLASS fijo + puerta abatible con cierre perfil imán



## COMBI D

FIJOS	Rango	Ref.	Puntos	PUERTAS	Medida	Ref.	Puntos
FIJO 20	17/20	1700	267	PUERTA 30	33/35,5	1725+1212	122
FIJO 25	22/25	1701	276	PUERTA 35	38/40,5	1727+1212	128
FIJO 30	27/30	1702	285	PUERTA 40	43/45,5	1726+1212	134
FIJO 40	37/40	1703	302	PUERTA 45	48/50,5	1728+1212	140
FIJO 50	47/50	1704	319	PUERTA 50	53/55,5	1706+1212	146
FIJO 60	57/60	1705	335	PUERTA 65	68/70,5	1707+1212	166
(3 cm ajuste)				PUERTA 70	73/75,5	1708+1212	171
Cierre perfil imán ref.1212			70	PUERTA 80	83/85,5	1709+1212	183
(2,5 cm ajuste)							



Paneles fijos y puertas a medida ver pág. 281

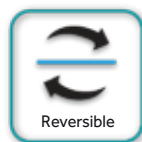

## COMBI D

Combinación con puertas 50, 65, 70 y 80

Medidas	Fijo	Puerta	Apertura	Rango	Referencia	Puntos
70	20	50	47	70-75,5	1700+1706+1212	413
75	25	50	47	75-80,5	1701+1706+1212	422
80	30	50	47	80-85,5	1702+1706+1212	431
85	20	65	62	85-90,5	1700+1707+1212	433
90	25	65	62	90-95,5	1701+1707+1212	442
90	20	70	67	90-95,5	1700+1708+1212	438
90	40	50	47	90-95,5	1703+1706+1212	448
95	25	70	67	95-100,5	1701+1708+1212	447
95	30	65	62	95-100,5	1702+1707+1212	451
100	30	70	67	100-105,5	1702+1708+1212	456
100	50	50	47	100-105,5	1704+1706+1212	465
100	20	80	77	100-105,5	1700+1709+1212	450
105	25	80	77	105-110,5	1701+1709+1212	459
105	40	65	62	105-110,5	1703+1707+1212	468
110	30	80	77	110-115,5	1702+1709+1212	468
110	40	70	67	110-115,5	1703+1708+1212	473
110	60	50	47	110-115,5	1705+1706+1212	481
115	50	65	62	115-120,5	1704+1707+1212	485
120	40	80	77	120-125,5	1703+1709+1212	485
120	50	70	67	120-125,5	1704+1708+1212	490
125	60	65	62	125-130,5	1705+1707+1212	501
130	50	80	77	130-135,5	1704+1709+1212	502
130	60	70	67	130-135,5	1705+1708+1212	506
140	60	80	77	140-145,5	1705+1709+1212	518

\*Permite uso perfil compensación en ambos lados

\*Permite combinación con Lateral fijo STD, rango mínimo +0,7 / expansión 3 cm (ver pág. 202)

Descripción	Referencias	Puntos
Perfil compensación +2 cm lado fijo	0218	25
Perfil compensación +4 cm lado fijo	0029	35
Imán expansión +1,2 cm (ver pág. 285)	1221	24



Opción barra 140 cm Ref. 1716  
Incremento 60 puntos





# GLASS fijo + 2 puertas abatibles + fijo



Opción barra 200 más soportes Ref. 1717  
Incremento 80 puntos

## COMBI G

FIJOS	Rango	Ref.	Puntos
FIJO 20	17/20	1700	267
FIJO 25	22/25	1701	276
FIJO 30	27/30	1702	285
FIJO 40	37/40	1703	302
FIJO 50	47/50	1704	319
FIJO 60	57/60	1705	335

(6 cm ajuste)

PUERTAS	Medida	Ref.	Puntos
PUERTA 30	30	1725	52
PUERTA 35	35	1727	58
PUERTA 40	40	1726	64
PUERTA 45	45	1728	70
PUERTA 50	50	1706	76
PUERTA 65	65	1707	96
PUERTA 70	70	1708	101
PUERTA 80	80	1709	113

(sin ajuste)



Paneles fijos y puertas a medida ver pág. 281



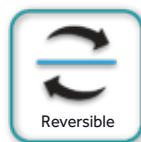

## COMBI G

Combinación con puertas 50, 65, 70 y 80

Medidas (F+P+P+F)	Rango	Referencia	Puntos
135(20+50+50+20)	129,5/135,5	1700+1706x2+1700	686
140(20+50+50+25)	134,5/140,5	1700+1706x2+1701	695
145(20+50+50+30)	139,5/145,5	1700+1706x2+1702	704
150(25+50+50+30)	144,5/150,5	1701+1706x2+1702	713
155(20+50+50+40)	149,5/155,5	1700+1706x2+1703	721
155(30+50+50+30)	149,5/155,5	1702+1706x2+1702	722
160(25+50+50+40)	154,5/160,5	1701+1706x2+1703	730
165(30+50+50+40)	159,5/165,5	1702+1706x2+1703	739
165(20+65+65+20)	159,5/165,5	1700+1707x2+1700	726
170(20+65+65+25)	164,5/170,5	1700+1707x2+1701	735
175(30+50+50+50)	169,5/175,5	1702+1706x2+1704	756
175(40+50+50+40)	169,5/175,5	1703+1706x2+1703	756
175(20+50+50+60)	169,5/175,5	1700+1706x2+1705	754
175(20+65+65+30)	169,5/175,5	1700+1707x2+1702	744
175(20+70+70+20)	169,5/175,5	1700+1708x2+1700	736
180(25+50+50+60)	174,5/180,5	1701+1706x2+1705	763
180(25+65+65+30)	174,5/180,5	1701+1707x2+1702	753
180(20+70+70+25)	174,5/180,5	1700+1708x2+1701	745
185(40+50+50+50)	179,5/185,5	1703+1706x2+1704	773
185(30+50+50+60)	179,5/185,5	1702+1706x2+1705	772
185(30+65+65+30)	179,5/185,5	1702+1707x2+1702	762
185(25+70+70+25)	179,5/185,5	1701+1708x2+1701	754
185(20+70+70+30)	179,5/185,5	1700+1708x2+1702	754
190(25+65+65+40)	184,5/190,5	1701+1707x2+1703	770
190(25+70+70+30)	184,5/190,5	1701+1708x2+1702	763
195(50+50+50+50)	189,5/195,5	1704+1706x2+1704	790
195(40+50+50+60)	189,5/195,5	1703+1706x2+1705	789
195(20+65+65+50)	189,5/195,5	1700+1707x2+1704	778
195(30+65+65+40)	189,5/195,5	1702+1707x2+1703	779
195(30+70+70+30)	189,5/195,5	1702+1708x2+1702	772
195(20+70+70+40)	189,5/195,5	1700+1708x2+1703	771

## COMBI G

Combinación con puertas 50, 65, 70 y 80

Medidas (F+P+P+F)	Rango	Referencia	Puntos
195(20+80+80+20)	189,5/195,5	1700+1709x2+1700	760
200(25+65+65+50)	194,5/200,5	1701+1707x2+1704	787
200(25+70+70+40)	194,5/200,5	1701+1708x2+1703	780
200(25+80+80+20)	194,5/200,5	1701+1709x2+1700	769
205(20+65+65+60)	199,5/205,5	1700+1707x2+1705	794
205(40+65+65+40)	199,5/205,5	1703+1707x2+1703	796
205(30+65+65+50)	199,5/205,5	1702+1707x2+1704	796
205(30+70+70+40)	199,5/205,5	1702+1708x2+1703	789
205(20+70+70+50)	199,5/205,5	1700+1708x2+1704	788
205(50+50+50+60)	199,5/205,5	1704+1706x2+1705	806
205(20+80+80+30)	199,5/205,5	1700+1709x2+1702	778
210(25+65+65+60)	204,5/210,5	1701+1707x2+1705	803
210(25+70+70+50)	204,5/210,5	1701+1708x2+1704	797
210(25+80+80+30)	204,5/210,5	1701+1709x2+1702	787
215(30+65+65+60)	209,5/215,5	1702+1707x2+1705	812
215(40+65+65+50)	209,5/215,5	1703+1707x2+1704	813
215(20+70+70+60)	209,5/215,5	1700+1708x2+1705	804
215(30+70+70+50)	209,5/215,5	1702+1708x2+1704	806
215(40+70+70+40)	209,5/215,5	1703+1708x2+1703	806
215(30+80+80+30)	209,5/215,5	1702+1709x2+1702	796
215(20+80+80+40)	209,5/215,5	1700+1709x2+1703	795
215(25+70+70+60)	209,5/215,5	1701+1708x2+1705	813
215(60+50+50+60)	209,5/215,5	1705+1706x2+1705	822
220(25+80+80+40)	214,5/220,5	1701+1709x2+1703	804
225(50+65+65+50)	219,5/225,5	1704+1707x2+1704	830
225(40+65+65+60)	219,5/225,5	1703+1707x2+1705	829
225(30+70+70+60)	219,5/225,5	1702+1708x2+1705	822
225(40+70+70+50)	219,5/225,5	1703+1708x2+1704	823
225(20+80+80+50)	219,5/225,5	1700+1709x2+1704	812

\*Permite unión con Lateral fijo STD en ambos lados (rango mínimo +0,7 cm / ajuste 3 cm), ver pág. 202

Descripción	Referencias	Puntos
Perfil compensación +2 cm	0218	25
Perfil compensación +4 cm	0029	35
Imán expansión +1,2 cm (ver pág. 285)	1221	24

# GLASS fijo + 2 puertas abatibles + fijo



Opción barra 200 más soportes Ref. 1717  
Incremento 80 puntos

## COMBI G

FIJOS	Rango	Ref.	Puntos
FIJO 20	17/20	1700	267
FIJO 25	22/25	1701	276
FIJO 30	27/30	1702	285
FIJO 40	37/40	1703	302
FIJO 50	47/50	1704	319
FIJO 60	57/60	1705	335

(6 cm ajuste)

PUERTAS	Medida	Ref.	Puntos
PUERTA 30	30	1725	52
PUERTA 35	35	1727	58
PUERTA 40	40	1726	64
PUERTA 45	45	1728	70
PUERTA 50	50	1706	76
PUERTA 65	65	1707	96
PUERTA 70	70	1708	101
PUERTA 80	80	1709	113

(sin ajuste)



Paneles fijos y puertas a medida ver pág. 281

**H195**

Altura

**8/6mm**

Grosor cristal



Abatible 90°



Magnético

**3cm**

Expansión

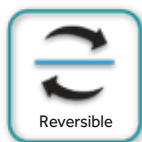

Reversible

aluminio  
**AL**  
aluminiumtratamiento antical  
clear shield glass

## COMBI G

Combinación con puertas 50, 65, 70 y 80

Medidas (F+P+P+F)	Rango	Referencia	Puntos
225 (30+80+80+40)	219,5/225,5	1702+1709x2+1703	813
230 (25+80+80+50)	224,5/230,5	1701+1709x2+1704	821
235 (50+65+65+60)	229,5/235,5	1704+1707x2+1705	846
235 (40+70+70+60)	229,5/235,5	1703+1708x2+1705	839
235 (50+70+70+50)	229,5/235,5	1704+1708x2+1704	840
235 (20+80+80+60)	229,5/235,5	1700+1709x2+1705	828
235 (40+80+80+40)	229,5/235,5	1703+1709x2+1703	830
240 (25+80+80+60)	234,5/240,5	1701+1709x2+1705	837
245 (60+65+65+60)	239,5/245,5	1705+1707x2+1705	862
245 (50+70+70+60)	239,5/245,5	1704+1708x2+1705	856
245 (30+80+80+60)	239,5/245,5	1702+1709x2+1705	846
245 (40+80+80+50)	239,5/245,5	1703+1709x2+1704	847
255 (60+70+70+60)	249,5/255,5	1705+1708x2+1705	872
255 (40+80+80+60)	249,5/255,5	1703+1709x2+1705	863
255 (50+80+80+50)	249,5/255,5	1704+1709x2+1704	864
265 (50+80+80+60)	259,5/265,5	1704+1709x2+1705	880
275 (60+80+80+60)	269,5/275,5	1705+1709x2+1705	896

\*Permite uso perfil compensación

\*Permite unión con Lateral fijo STD en ambos lados (rango mínimo +0,7 cm / ajuste 3 cm), ver pág. 202

Descripción	Referencias	Puntos
Perfil compensación +2 cm	<b>0218</b>	<b>25</b>
Perfil compensación +4 cm	<b>0029</b>	<b>35</b>
Imán expansión +1,2 cm (ver pág. 285)	<b>1221</b>	<b>24</b>

Opción barra 200 más soportes Ref. 1717  
Incremento 80 puntos

Brazo incluido



Bisagra en latón

# GLASS angular 2 puertas abatibles + 2 fijos



## COMBI H

FIJOS	Rango	Ref.	Puntos
FIJO 20	17/20	1700	267
FIJO 25	22/25	1701	276
FIJO 30	27/30	1702	285
FIJO 40	37/40	1703	302
FIJO 50	47/50	1704	319
FIJO 60	57/60	1705	335

(3 cm ajuste)

PUERTAS	Medida	Ref.	Puntos
PUERTA 30	30	1725	52
PUERTA 35	35	1727	58
PUERTA 40	40	1726	64
PUERTA 45	45	1728	70
PUERTA 50	50	1706	76
PUERTA 65	65	1707	96
PUERTA 70	70	1708	101
PUERTA 80	80	1709	113

(sin ajuste)



Paneles fijos y puertas a medida ver pág. 281

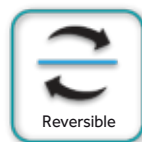

## COMBI H

Combinación con puertas 50, 65, 70 y 80

Medidas (F+P+P+F)	Rango	Referencia	Puntos
70X70(20+50+50+20)	67-70/67-70	1700+1706x2+1700	686
75X75(25+50+50+25)	72-74/72-74	1701+1706x2+1701	704
80X80(30+50+50+30)	77-80/77-80	1702+1706x2+1702	722
85x85(20+65+65+20)	82-85/82-85	1700+1707x2+1700	726
90x90(40+50+50+40)	87-90/87-90	1703+1706x2+1703	756
90x90(25+65+65+25)	87-90/87-90	1701+1707x2+1701	744
90x90(20+70+70+20)	87-90/87-90	1700+1708x2+1700	736
95x95(30+65+65+30)	92-95/92-95	1702+1707x2+1702	762
100x100(30+70+70+30)	97-100/97-100	1702+1708x2+1702	772
100x100(50+50+50+50)	97-100/97-100	1704+1706x2+1704	790
90x70(40+50+50+20)	87-90 / 67-70	1703+1706x2+1700	721
90x70(25+65+50+20)	87-90 / 67-70	1701+1707+1706+1700	715
90x70(20+70+50+20)	87-90 / 67-70	1700+1708+1706+1700	711
95x70(30+65+50+20)	92-95 / 67-70	1702+1707+1706+1700	724
95x70(25+70+50+20)	92-95 / 67-70	1701+1708+1706+1700	720
100x70(30+70+50+20)	97-100 / 67-70	1702+1708+1706+1700	729
100x70(20+80+50+20)	97-100 / 67-70	1700+1709+1706+1700	723
105x70(40+65+50+20)	102-105 / 67-70	1703+1707+1706+1700	741
105x70(25+80+50+20)	102-105 / 67-70	1701+1709+1706+1700	732
110x70(40+70+50+20)	107-110 / 67-70	1703+1708+1706+1700	746
110x70(30+80+50+20)	107-110 / 67-70	1702+1709+1706+1700	741
110x70(60+50+50+20)	107-110/ 67-70	1705+1706+1706+1700	754
115x70(50+65+50+20)	112-115/ 67-70	1704+1707+1706+1700	758
120x70(50+70+50+20)	117-120 / 67-70	1704+1708+1706+1700	763
120x70(40+80+50+20)	117-120 / 67-70	1703+1709+1706+1700	758
125x70(60+65+50+20)	122-125 / 67-70	1705+1707+1706+1700	774
130x70(50+80+50+20)	127-130 / 67-70	1704+1709+1706+1700	775
130x70(60+70+50+20)	127-130 / 67-70	1705+1708+1706+1700	779
140x70(60+80+50+20)	137-140 / 67-70	1705+1709+1706+1700	791
90x80(40+50+50+30)	87-90 / 77-80	1703+1706x2+1702	739
90x80(25+65+50+30)	87-90 / 77-80	1701+1707+1706+1702	733

## COMBI H

Combinación con puertas 50, 65, 70 y 80

Medidas (F+P+P+F)	Rango	Referencia	Puntos
90x80(20+70+50+30)	87-90 / 77-80	1700+1708+1706+1702	729
95x80(30+65+50+30)	92-95 / 77-80	1702+1707+1706+1702	742
95x80(25+70+50+30)	92-95 / 77-80	1701+1708+1706+1702	738
100x80(30+70+50+30)	97-100 / 77-80	1702+1708+1706+1702	747
100x80(20+80+50+30)	97-100 / 77-80	1700+1709+1706+1702	741
105x80(40+65+50+30)	102-105 / 77-80	1703+1707+1706+1702	759
105x80(25+80+50+30)	102-105 / 77-80	1701+1709+1706+1702	750
110X80(60+50+50+30)	107-110 / 77-80	1705+1706+1706+1702	772
110X80(40+70+50+30)	107-110 / 77-80	1703+1708+1706+1702	764
110X80(30+80+50+30)	107-110 / 77-80	1702+1709+1706+1702	759
115X80(50+65+50+30)	112-115 / 77-80	1704+1707+1706+1702	776
120x80(50+70+50+30)	117-120 / 77-80	1704+1708+1706+1702	781
120x80(40+80+50+30)	117-120 / 77-80	1703+1709+1706+1702	776
125x80(60+65+50+30)	122-125 / 77-80	1705+1707+1706+1702	792
130x80(50+80+50+30)	127-130 / 77-80	1704+1709+1706+1702	793
130x80(60+70+50+30)	127-130 / 77-80	1705+1708+1706+1702	797
140x80(60+80+50+30)	137-140 / 77-80	1705+1709+1706+1702	809
95x90(30+65+50+40)	92-95 / 87-90	1702+1707+1706+1703	759
95x90(25+70+50+40)	92-95 / 87-90	1701+1708+1706+1703	755
95x90(30+65+65+25)	92-95 / 87-90	1702+1707x2+1701	753
95x90(25+70+65+25)	92-95 / 87-90	1701+1708+1707+1701	749
95x90(30+65+70+20)	92-95 / 87-90	1702+1707+1708+1700	749
95x90(25+70+70+20)	92-95 / 87-90	1701+1708x2+1700	745
100x90(30+70+50+40)	97-100 / 87-90	1702+1708+1706+1703	764
100x90(20+80+50+40)	97-100 / 87-90	1700+1709+1706+1703	758
100x90(30+70+65+25)	97-100 / 87-90	1702+1708+1707+1701	758
100x90(20+80+65+25)	97-100 / 87-90	1700+1709+1707+1701	752
100x90(30+70+70+20)	97-100 / 87-90	1702+1708x2+1700	754
100x90(20+80+70+20)	97-100 / 87-90	1700+1709+1708+1700	748
105x90(40+65+50+40)	102-105 / 87-90	1703+1707+1706+1703	776
105x90(25+80+50+40)	102-105 / 87-90	1701+1709+1706+1703	767

\*Permite uso perfil compensación en ambos lados

Descripción	Referencias	Puntos
Perfil compensación +2 cm	0218	25
Perfil compensación +4 cm	0029	35

# GLASS angular 2 puertas abatibles + 2 fijos



## COMBI H

FIJOS	Rango	Ref.	Puntos
FIJO 20	17/20	1700	267
FIJO 25	22/25	1701	276
FIJO 30	27/30	1702	285
FIJO 40	37/40	1703	302
FIJO 50	47/50	1704	319
FIJO 60	57/60	1705	335

(3 cm ajuste)

PUERTAS	Medida	Ref.	Puntos
PUERTA 30	30	1725	52
PUERTA 35	35	1727	58
PUERTA 40	40	1726	64
PUERTA 45	45	1728	70
PUERTA 50	50	1706	76
PUERTA 65	65	1707	96
PUERTA 70	70	1708	101
PUERTA 80	80	1709	113

(sin ajuste)



Paneles fijos y puertas a medida ver pág. 281





H195

Altura



8/6mm

Grosor cristal



Abatible 90°



Magnético



3cm

Expansión

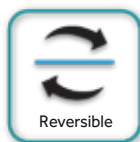

Reversible



aluminio  
AL  
aluminium



tratamiento antical  
clear shield glass

## COMBI H

Combinación con puertas 50, 65, 70 y 80

Medidas (F+P+P+F)	Rango	Referencia	Puntos
105x90(40+65+65+25)	102-105 / 87-90	1703+1707x2+1701	770
105x90(25+80+65+25)	102-105 / 87-90	1701+1709+1707+1701	761
105x90(40+65+70+20)	102-105 / 87-90	1703+1707+1708+1700	766
105x90(25+80+70+20)	102-105 / 87-90	1701+1709+1708+1700	757
110x90(60+50+50+40)	107-110 / 87-90	1705+1706x2+1703	789
110x90(40+70+50+40)	107-110 / 87-90	1703+1708+1706+1703	781
110x90(30+80+50+40)	107-110 / 87-90	1702+1709+1706+1703	776
110x90(60+50+65+25)	107-110 / 87-90	1705+1706+1707+1701	783
110x90(40+70+65+25)	107-110 / 87-90	1703+1708+1707+1701	775
110x90(30+80+65+25)	107-110 / 87-90	1702+1709+1707+1701	770
110x90(60+50+70+20)	107-110 / 87-90	1705+1706+1708+1700	779
110x90(40+70+70+20)	107-110 / 87-90	1703+1708x2+1700	771
110x90(30+80+70+20)	107-110 / 87-90	1702+1709+1708+1700	766
115x90(50+65+50+40)	112-115 / 87-90	1704+1707+1706+1703	793
115x90(50+65+65+25)	112-115 / 87-90	1704+1707x2+1701	787
115x90(50+65+70+20)	112-115 / 87-90	1704+1707+1708+1700	783
120x90(50+70+50+40)	117-120 / 87-90	1704+1708+1706+1703	798
120x90(40+80+50+40)	117-120 / 87-90	1703+1709+1706+1703	793

## COMBI H

Combinación con puertas 50, 65, 70 y 80

Medidas (F+P+P+F)	Rango	Referencia	Puntos
120x90(50+70+65+25)	117-120 / 87-90	1704+1708+1707+1701	792
120x90(40+80+65+25)	117-120 / 87-90	1703+1709+1707+1701	787
120x90(50+70+70+20)	117-120 / 87-90	1704+1708x2+1700	788
120x90(40+80+70+20)	117-120 / 87-90	1703+1709+1708+1700	783
125x90(60+65+50+40)	122-125 / 87-90	1705+1707+1706+1703	809
125x90(60+65+65+25)	122-125 / 87-90	1705+1707x2+1701	803
125x90(60+65+70+20)	122-125 / 87-90	1705+1707+1708+1700	799
130x90(60+70+50+40)	127-130 / 87-90	1705+1708+1706+1703	814
130x90(50+80+50+40)	127-130 / 87-90	1704+1709+1706+1703	810
130x90(50+80+65+25)	127-130 / 87-90	1704+1709+1707+1701	804
130x90(60+70+70+20)	127-130 / 87-90	1705+1708x2+1700	804
130x90(50+80+70+20)	127-130 / 87-90	1704+1709+1708+1700	800
140x90(60+80+50+40)	137-140 / 87-90	1705+1709+1706+1703	826
140x90(60+80+65+25)	137-140 / 87-90	1705+1709+1707+1701	820
140x90(60+80+70+20)	137-140 / 87-90	1705+1709+1708+1700	816

\*Permite uso perfil compensación en ambos lados

Descripción	Referencias	Puntos
Perfil compensación +2 cm	0218	25
Perfil compensación +4 cm	0029	35



Opción barras + soportes Ref. 1716x2+1730  
Incremento 135 puntos



## GLASS PLEGABLE pg.244

1 panel + 1 puerta plegables



## GLASS PLEGABLE BLACK pg.244

1 panel + 1 puerta plegables



**TANDEM pg.248**

Plegable + fijo y corredera



**AKORD pg.250**

2 puertas plegable



PLEGABLES

**MAMPARAS  
PLEGABLES**

**H195**

Altura

**6mm**

Grosor cristal



Plegable



Magnético

**1.5cm**

Combi 1

**2.5/1.5cm**

Combi 2



Reversible

aluminio  
**AL**  
aluminium

Clear shield glass

## GLASS PLEGABLE al interior de plato



### COMBI 1 con cierre imán a pared

Medidas	Rango	Referencias	Puntos
60 (30+30)	57,5/59	1712+1725	342
70 (40+30)	67,5/69	1713+1725	355
75 (40+35)	72,5/74	1713+1727	361
80 (40+40)	77,5/79	1713+1726	367
80 (50+30)	77,5/79	1714+1725	367
85 (50+35)	82,5/84	1714+1727	373
90 (50+40)	87,5/89	1714+1726	379
95 (50+45)	92,5/94	1714+1728	385
100 (50+50)	97,5/99	1714+1706	391

Permite combinación con lateral fijo Glass en lado puerta, el rango del frontal se reducirá en 0,5 cm

Descripción	Ref.	Puntos
Perfil puerta (reduce hasta 1 cm el rango)	1215	29
Perfil expansión +2,5 cm	1222	48
Imanes de expansión +1,2 cm	1221	24



Opción puertas a medida (ver pág. 281)

Descripción	Ref.	Puntos
Puerta < 80 cm	1338	150

### COMBI 2 con cierre perfil imán

Medida	Rango	Referencias	Puntos
65 (30+30)	60/64	1712+1725+1212	412
75 (40+30)	70/74	1713+1725+1212	425
80 (40+35)	75/79	1713+1727+1212	431
85 (40+40)	80/84	1713+1726+1212	437
85 (50+30)	80/84	1714+1725+1212	437
90 (50+35)	85/89	1714+1727+1212	443
95 (50+40)	90/94	1714+1726+1212	449
100 (50+45)	95/99	1714+1728+1212	455
105 (50+50)	100/104	1714+1706+1212	461

Permite combinación con Lateral fijo STD en lado puerta, el rango mínimo el frontal aumenta 0,7 cm

Descripción	Ref.	Puntos
Perfil puerta (reduce hasta 1 cm el rango)	1215	29
Perfil expansión lado cristal +2,5 cm	1222	48
Imanes de expansión +1,2 cm	1221	24
Perfil exp. lado cierre perfil imán (+3 cm)	0218	25
Perfil exp. lado cierre perfil imán (+6 cm)	0029	35

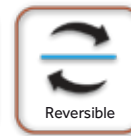

## GLASS PLEGABLE BLACK al interior de plato



COMBI 1 con cierre imán a pared

Medidas	Rango	Referencias	Puntos
60 (30+30)	57,5/59	1712N+1725	362
70 (40+30)	67,5/69	1713N+1725	375
75 (40+35)	72,5/74	1713N+1727	381
80 (40+40)	77,5/79	1713N+1726	387
80 (50+30)	77,5/79	1714N+1725	387
85 (50+35)	82,5/84	1714N+1727	393
90 (50+40)	87,5/89	1714N+1726	399
95 (50+45)	92,5/94	1714N+1728	405
100 (50+50)	97,5/99	1714N+1706	411

Permite combinación con lateral fijo Glass en lado puerta, el rango del frontal se reducirá en 0,5 cm

Descripción	Ref.	Puntos
Perfil puerta (reduce hasta 1 cm el rango)	9014	25
Perfil expansión +2,5 cm	9015	48
Imanes de expansión +1,2 cm	1221	24

COMBI 2 con cierre perfil imán

Medida	Rango	Referencias	Puntos
65 (30+30)	60/64	1712N+1725+9013	432
75 (40+30)	70/74	1713N+1725+9013	445
80 (40+35)	75/79	1713N+1727+9013	451
85 (40+40)	80/84	1713N+1726+9013	457
85 (50+30)	80/84	1714N+1725+9013	457
90 (50+35)	85/89	1714N+1727+9013	463
95 (50+40)	90/94	1714N+1726+9013	469
100 (50+45)	95/99	1714N+1728+9013	475
105 (50+50)	100/104	1714N+1706+9013	481

Permite combinación con Lateral fijo STD en lado puerta, el rango mínimo el frontal aumenta 0,7 cm

Descripción	Ref.	Puntos
Perfil puerta (reduce hasta 1 cm el rango)	9014	25
Perfil expansión lado cristal +2,5 cm	9015	48
Imanes de expansión +1,2 cm	1221	24
Perfil exp. lado cierre perfil imán (+3 cm)	9016	29



Opción puertas a medida (ver pág. 281)

Descripción	Ref.	Puntos
Puerta < 80 cm	1338	150

# GLASS PLEGABLE al interior de plato + lat. fijo



## COMBI 1 + LATERAL FIJO 70 c/BRAZO 1715

Medidas	Rango	Referencias	Puntos
60 (30+30)x70	57-58,5/66-69	1712+1725+1720F+1715	542
70 (40+30)x70	67-68,5/66-69	1713+1725+1720F+1715	555
75 (40+35)x70	72-73,5/66-69	1713+1727+1720F+1715	561
80 (40+40)x70	77-78,5/66-69	1713+1726+1720F+1715	567
80 (50+30)x70	77-78,5/66-69	1714+1725+1720F+1715	567
85 (50+35)x70	82-83,5/66-69	1714+1727+1720F+1715	573
90 (50+40)x70	87-88,5/66-69	1714+1726+1720F+1715	579
95 (50+45)x70	92-93,5/66-69	1714+1728+1720F+1715	585
100 (50+50)x70	97-98,5/66-69	1714+1706+1720F+1715	591

## COMBI 1 + LATERAL FIJO 80 c/BRAZO 1715

Medidas	Rango	Referencias	Puntos
60 (30+30)x80	57-58,5/76-79	1712+1725+1721F+1715	554
70 (40+30)x80	67-68,5/76-79	1713+1725+1721F+1715	567
75 (40+35)x80	72-73,5/76-79	1713+1727+1721F+1715	573
80 (40+40)x80	77-78,5/76-79	1713+1726+1721F+1715	579
80 (50+30)x80	77-78,5/76-79	1714+1725+1721F+1715	579
85 (50+35)x80	82-83,5/76-79	1714+1727+1721F+1715	585
90 (50+40)x80	87-88,5/76-79	1714+1726+1721F+1715	591
95 (50+45)x80	92-93,5/76-79	1714+1728+1721F+1715	597
100 (50+50)x80	97-98,5/76-79	1714+1706+1721F+1715	603

## COMBI 1 + LATERAL FIJO 90 c/BRAZO 1715

Medidas	Rango	Referencias	Puntos
60 (30+30)x90	57-58,5/86-89	1712+1725+1722F+1715	566
70 (40+30)x90	67-68,5/86-89	1713+1725+1722F+1715	579
75 (40+35)x90	72-73,5/86-89	1713+1727+1722F+1715	585
80 (40+40)x90	77-78,5/86-89	1713+1726+1722F+1715	591
80 (50+30)x90	77-78,5/86-89	1714+1725+1722F+1715	591
85 (50+35)x90	82-83,5/86-89	1714+1727+1722F+1715	597
90 (50+40)x90	87-88,5/86-89	1714+1726+1722F+1715	603
95 (50+45)x90	92-93,5/86-89	1714+1728+1722F+1715	609
100 (50+50)x90	97-98,5/86-89	1714+1706+1722F+1715	615

## Laterales fijos GLASS PLEGABLE 6 mm

Descripción	Rango	Referencias	Puntos
Lateral fijo 70	66 - 69	1720F	166
Lateral fijo 80	76 - 79	1721F	178
Lateral fijo 90	86 - 89	1722F	190

Descripción	Referencias	Puntos
Perfil compensación +2 cm	0218	25
Perfil compensación +4 cm	0029	35
Perfil compensación +5,5 cm	0219	35

## Opciones brazos

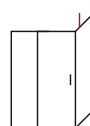

Brazo 45°  
ref. 1715

Puntos

34

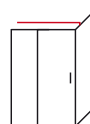

Barra 140 con soporte  
ref. 1716+1718

76



## Laterales fijos a medida 6 mm (más información en página 282)

Descripción	Referencias	Puntos	Cajonado
Lateral fijo a medida OPEN hasta 40 cm	1345	175	+21
Lateral fijo a medida OPEN de 40 hasta 80 cm	1316	250	+21
Lateral fijo a medida OPEN de 80 hasta 120 cm	1317	320	+21

\*Plazo de entrega 15 días



# GLASS PLEGABLE BLACK al interior de plato + lat. fijo



## COMBI 1 + LATERAL FIJO 70 c/BRAZO 9017

Medidas	Rango	Referencias	Puntos
60 (30+30)x70	57-58,5/66-69	1712N+1725+1720FN+9017	576
70 (40+30)x70	67-68,5/66-69	1713N+1725+1720FN+9017	589
75 (40+35)x70	72-73,5/66-69	1713N+1727+1720FN+9017	595
80 (40+40)x70	77-78,5/66-69	1713N+1726+1720FN+9017	601
80 (50+30)x70	77-78,5/66-69	1714N+1725+1720FN+9017	601
85 (50+35)x70	82-83,5/66-69	1714N+1727+1720FN+9017	607
90 (50+40)x70	87-88,5/66-69	1714N+1726+1720FN+9017	613
95 (50+45)x70	92-93,5/66-69	1714N+1728+1720FN+9017	619
100 (50+50)x70	97-98,5/66-69	1714N+1706+1720FN+9017	625

## COMBI 1 + LATERAL FIJO 80 c/BRAZO 9017

Medidas	Rango	Referencias	Puntos
60 (30+30)x80	57-58,5/76-79	1712N+1725+1721FN+9017	588
70 (40+30)x80	67-68,5/76-79	1713N+1725+1721FN+9017	601
75 (40+35)x80	72-73,5/76-79	1713N+1727+1721FN+9017	607
80 (40+40)x80	77-78,5/76-79	1713N+1726+1721FN+9017	613
80 (50+30)x80	77-78,5/76-79	1714N+1725+1721FN+9017	613
85 (50+35)x80	82-83,5/76-79	1714N+1727+1721FN+9017	619
90 (50+40)x80	87-88,5/76-79	1714N+1726+1721FN+9017	625
95 (50+45)x80	92-93,5/76-79	1714N+1728+1721FN+9017	631
100 (50+50)x80	97-98,5/76-79	1714N+1706+1721FN+9017	637

## COMBI 1 + LATERAL FIJO 90 c/BRAZO 9017

Medidas	Rango	Referencias	Puntos
60 (30+30)x90	57-58,5/86-89	1712N+1725+1722FN+9017	600
70 (40+30)x90	67-68,5/86-89	1713N+1725+1722FN+9017	613
75 (40+35)x90	72-73,5/86-89	1713N+1727+1722FN+9017	619
80 (40+40)x90	77-78,5/86-89	1713N+1726+1722FN+9017	625
80 (50+30)x90	77-78,5/86-89	1714N+1725+1722FN+9017	625
85 (50+35)x90	82-83,5/86-89	1714N+1727+1722FN+9017	631
90 (50+40)x90	87-88,5/86-89	1714N+1726+1722FN+9017	637
95 (50+45)x90	92-93,5/86-89	1714N+1728+1722FN+9017	643
100 (50+50)x90	97-98,5/86-89	1714N+1706+1722FN+9017	649

## Laterales fijos GLASS PLEGABLE BLACK 6 mm

Descripción	Rango	Referencias	Puntos
Lateral fijo 70	66 - 69	1720FN	176
Lateral fijo 80	76 - 79	1721FN	188
Lateral fijo 90	86 - 89	1722FN	200

Descripción	Referencias	Puntos
Perfil compensación negro+2 cm	9016	29

## Opciones brazos

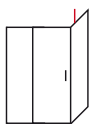
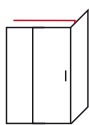
	Puntos
 <b>Brazo 45° ref. 9017</b>	38
 <b>Barra 140 con soporte ref. 9026+9028</b>	80



## Laterales fijos a medida 6 mm (más información en página 282)

Descripción	Referencias	Puntos	Cajonado
Lateral fijo a medida OPEN BLACK hasta 40 cm	1345N	207	+21
Lateral fijo a medida OPEN BLACK de 40 hasta 80 cm	1316N	282	+21
Lateral fijo a medida OPEN BLACK de 80 hasta 120 cm	1317N	352	+21

\*Plazo de entrega 15 días

TANDEM fijo + corredera y plegable



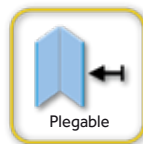
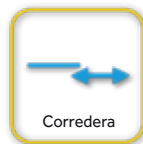

## combinaciones TANDEM angular

F+CxPleg.	Ap.	Rangos	Referencias	Puntos	F+CxPleg.	Ap.	Rangos	Referencias	Puntos
70x70	59	63-68 / 66,5-69,5	5018+5423+1740	669	70x75	66	63-68 / 71,5-74,5	5018+5423+1743	675
75x70	59	68-73 / 66,5-69,5	5029+5423+1740	674	75x75	67	68-73 / 71,5-74,5	5029+5423+1743	680
80x70	61	73-78 / 66,5-69,5	5019+5423+1740	679	80x75	68	73-78 / 71,5-74,5	5019+5423+1743	685
85x70	63	78-83 / 66,5-69,5	5030+5423+1740	685	85x75	69	78-83 / 71,5-74,5	5030+5423+1743	691
90x70	64	83-88 / 66,5-69,5	5020+5423+1740	690	90x75	70	83-88 / 71,5-74,5	5020+5423+1743	696
95x70	66	88-93 / 66,5-69,5	5031+5423+1740	693	95x75	72	88-93 / 71,5-74,5	5031+5423+1743	699
100x70	67	93-98 / 66,5-69,5	5021+5423+1740	695	100x75	73	93-98 / 71,5-74,5	5021+5423+1743	701
110x70	68	102-107 / 66,5-69,5	5002+5423+1740	705	110x75	74	102-107 / 71,5-74,5	5002+5423+1743	711
120x70	73	113-118 / 66,5-69,5	5022+5423+1740	716	120x75	79	113-118 / 71,5-74,5	5022+5423+1743	722
130x70	74	122-127 / 66,5-69,5	5006+5424+1740	737	130x75	80	122-127 / 71,5-74,5	5006+5424+1743	743
140x70	78	132-137 / 66,5-69,5	5008+5424+1740	746	140x75	83	132-137 / 71,5-74,5	5008+5424+1743	752
F+CxPleg.	Ap.	Rangos	Referencias	Puntos	F+CxPleg.	Ap.	Rangos	Referencias	Puntos
70X80	68	63-68 / 76,5-79,5	5018+5423+1741	680	70X90	77	63-68 / 86,5-89,5	5018+5423+1742	691
75x80	68	68-73 / 76,5-79,5	5029+5423+1741	685	75x90	77	68-73 / 86,5-89,5	5029+5423+1742	696
80X80	70	73-78 / 76,5-79,5	5019+5423+1741	690	80x90	79	73-78 / 86,5-89,5	5019+5423+1742	701
85x80	71	78-83 / 76,5-79,5	5030+5423+1741	696	85x90	80	78-83 / 86,5-89,5	5030+5423+1742	707
90X80	72	83-88 / 76,5-79,5	5020+5423+1741	701	90X90	81	83-88 / 86,5-89,5	5020+5423+1742	712
95x80	74	88-93 / 76,5-79,5	5031+5423+1741	704	95x90	82	88-93 / 86,5-89,5	5031+5423+1742	715
100X80	75	93-98 / 76,5-79,5	5021+5423+1741	706	100X90	83	93-98 / 86,5-89,5	5021+5423+1742	717
110x80	76	102-107 / 76,5-79,5	5002+5423+1741	716	110x90	84	102-107 / 86,5-89,5	5002+5423+1742	727
120X80	81	113-118 / 76,5-79,5	5022+5423+1741	727	120X90	88	113-118 / 86,5-89,5	5022+5423+1742	738
130X80	82	122-127 / 76,5-79,5	5006+5424+1741	748	130x90	89	122-127 / 86,5-89,5	5006+5424+1742	759
140X80	85	132-137 / 76,5-79,5	5008+5424+1741	757	140X90	92	132-137 / 86,5-89,5	5008+5424+1742	768

Se pueden combinar con frontales Basic de medidas intermedias, rango +2 cm.

Descripción	Referencias	Puntos
Perfil compensación +1,5 cm para lado fijo + corredera	5429	25
Perfil compensación +2,5 para lado plegable	1222	48



Mamparas a medida y cristales especiales	Cajonado
- Mamparas a medida +45%	+21

Se puede fabricar a medida el lado de fijo y corredera y la puerta del lado plegable con altura 195 cm.  
\*Plazo de entrega 15 días

## AKORD plegable



### Frontales AKORD

Descripción	Apertura	Rango	Referencias	Puntos
Frontal AKORD 70 plegable	50	66-71	<b>0830</b>	<b>429</b>
Frontal AKORD 80 plegable	60	76-81	<b>0831</b>	<b>440</b>
Frontal AKORD 90 plegable	70	86-91	<b>0832</b>	<b>452</b>
Frontal AKORD 100 plegable	80	96-101	<b>0833</b>	<b>464</b>

Descripción	Referencias	Puntos
Perfil compensación +2 cm	<b>0218</b>	<b>25</b>
Perfil compensación +4 cm	<b>0029</b>	<b>35</b>



H195

Altura



4mm

Grosor cristal



Plegable



2.5cm

Expansión



Magnético



Reversible



aluminio  
AL  
aluminium



Tratamiento antical  
CLEAR  
SHIELD  
GLASS



Sistema de hojas plegables



Tirador interno

### Combinaciones frontales AKORD + Lateral fijo STD

Medidas	Rangos	Referencias	Puntos
70X70	66,4-68,9/66-69	0830+0814	624
80X70	76,4-78,9/66-69	0831+0814	635
90X70	86,4-88,9/66-69	0832+0814	647
100X70	96,4-98,9/66-69	0833+0814	659

Medidas	Rangos	Referencias	Puntos
70X75	66,4-68,9/71-74	0830+0820	629
80X75	76,4-78,9/71-74	0831+0820	640
90X75	86,4-88,9/71-74	0832+0820	652
100X75	96,4-98,9/71-74	0833+0820	664

Medidas	Rangos	Referencias	Puntos
70X80	66,4-68,9/76-79	0830+0815	634
80X80	76,4-78,9/76-79	0831+0815	645
90X80	86,4-88,9/76-79	0832+0815	657
100X80	96,4-98,9/76-79	0833+0815	669

Medidas	Rangos	Referencias	Puntos
70X90	66,4-68,9/86-89	0830+0816	649
80X90	76,4-78,9/86-89	0831+0816	660
90X90	86,4-88,9/86-89	0832+0816	672
100X90	96,4-98,9/86-89	0833+0816	684

\*Se puede combinar con resto de medidas fijos STD (ver pág. 64)

Descripción	Referencias	Puntos
Perfil compensación +2 cm	0218	25
Perfil compensación +4 cm	0029	35



### Laterales fijos a medida (más información en página 282)

Descripción	Referencias	Puntos	Cajonado
Lateral fijo a medida hasta 40 cm	1343	175	+21
Lateral fijo a medida desde 40 hasta 80 cm	1304	250	+21
Lateral fijo a medida desde 80 hasta 120 cm	1310	320	+21

\*Plazo de entrega 15 días

# GME

## TRIO pg.254

1 fijo y 2 correderas



## BYPASS pg.256

2 correderas





## GIRO 360° pg.258

Puerta giratoria



## PUERTAS DE PASO pg.262

Corredera



+SOLUCIONES

# OTRAS SOLUCIONES

# TRIO 1fijo + 2correderas

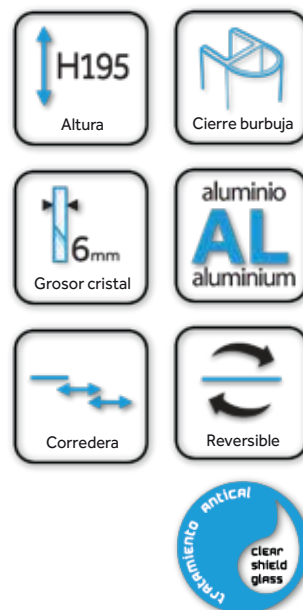

Pletina embellecedora

Descripción	Rango	Apertura	Referencias	Puntos
Frontal 1fijo+2correderas TRIO 90	86-91	43-45	1230	470
Frontal 1fijo+2correderas TRIO 95	91-96	46-48	1231	480
Frontal 1fijo+2correderas TRIO 100	96-101	49-51	1232	490
Frontal 1fijo+2correderas TRIO 105	101-106	53-55	1233	500
Frontal 1fijo+2correderas TRIO 110	106-111	56-58	1234	511
Frontal 1fijo+2correderas TRIO 115	111-116	59-61	1235	521
Frontal 1fijo+2correderas TRIO 120	116-121	63-65	1236	530
Frontal 1fijo+2correderas TRIO 125	121-126	66-68	1237	537
Frontal 1fijo+2correderas TRIO 130	126-131	69-71	1238	546
Frontal 1fijo+2correderas TRIO 135	131-136	73-75	1239	554
Frontal 1fijo+2correderas TRIO 140	136-141	76-78	1240	560
Frontal 1fijo+2correderas TRIO 145	141-146	79-81	1243	572
Frontal 1fijo+2correderas TRIO 150	146-151	82-84	1244	583
Frontal 1fijo+2correderas TRIO 155	151-156	85-88	1245	596
Frontal 1fijo+2correderas TRIO 160	156-161	89-91	1246	608
Pletina embellecedora 195x3,8 cm			0007	30

# TRIO frontal + lateral fijo

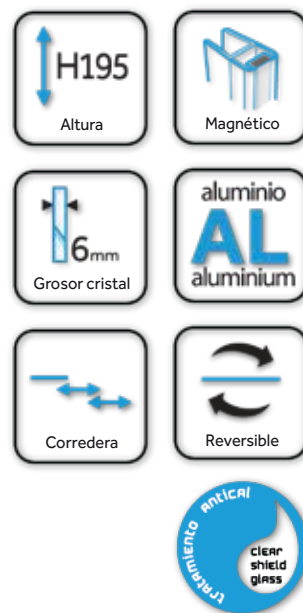

## Laterales fijos TRIO

Descripción	Rango	Ref.	Puntos
Lateral fijo TRIO 70	67-69,5	1241	230
Lateral fijo TRIO 80	77-79,5	1242	242
Perfil compensación lateral fijo +3 cm		0218	25
Perfil compensación lateral fijo +6 cm		0029	35

\*Perfiles de compensación sólo para laterales fijos.

## Combinaciones frontales TRIO + lateral fijo

Medidas	Rangos	Referencias	Puntos	Medidas	Rangos	Referencias	Puntos
90x70	87-89,5 / 67-69,5	1230 + 1241	700	90x80	87-89,5 / 77-79,5	1230 + 1242	712
95x70	92-94,5 / 67-69,5	1231 + 1241	710	95x80	92-94,5 / 77-79,5	1231 + 1242	722
100x70	97-99,5 / 67-69,5	1232 + 1241	720	100x80	97-99,5 / 77-79,5	1232 + 1242	732
105x70	102-104,5 / 67-69,5	1233 + 1241	730	105x80	102-104,5 / 77-79,5	1233 + 1242	742
110x70	107-109,5 / 67-69,5	1234 + 1241	741	110x80	107-109,5 / 77-79,5	1234 + 1242	753
115x70	112-114,5 / 67-69,5	1235 + 1241	751	115x80	112-114,5 / 77-79,5	1235 + 1242	763
120x70	117-119,5 / 67-69,5	1236 + 1241	760	120x80	117-119,5 / 77-79,5	1236 + 1242	772
125x70	122-124,5 / 67-69,5	1237 + 1241	767	125x80	122-124,5 / 77-79,5	1237 + 1242	779
130x70	127-129,5 / 67-69,5	1238 + 1241	776	130x80	127-129,5 / 77-79,5	1238 + 1242	788
135x70	132-134,5 / 67-69,5	1239 + 1241	784	135x80	132-134,5 / 77-79,5	1239 + 1242	796
140x70	137-139,5 / 67-69,5	1240 + 1241	790	140x80	137-139,5 / 77-79,5	1240 + 1242	802
145x70	142-144,5 / 67-69,5	1243 + 1241	802	145x80	142-144,5 / 77-79,5	1243 + 1242	814
150x70	147-149,5 / 67-69,5	1244 + 1241	813	150x80	147-149,5 / 77-79,5	1244 + 1242	825
155x70	152-154,5 / 67-69,5	1245 + 1241	826	155x80	152-154,5 / 77-79,5	1245 + 1242	838
160x70	157-159,5 / 67-69,5	1246 + 1241	838	160x80	157-159,5 / 77-79,5	1246 + 1242	850



## Laterales fijos a Medida TRIO (más información en página 282)

Descripción	Referencias	Puntos	Cajonado
Lateral fijo a medida hasta 40 cm	1342	206	+21
Lateral fijo a medida desde 40 hasta 80 cm	1303	286	+21
Lateral fijo a medida desde 80 hasta 120 cm	1309	356	+21

\*Plazo de entrega 15 días

## BYPASS 2 correderas



Descripción	Rango	Apertura	Referencias	Puntos
Frontal BYPASS <b>120</b>	108-118	45-55	<b>1270</b>	<b>548</b>
Frontal BYPASS <b>130</b>	118-128	50-60	<b>1271</b>	<b>564</b>
Frontal BYPASS <b>140</b>	128-138	55-65	<b>1272</b>	<b>581</b>
Frontal BYPASS <b>150</b>	138-148	60-70	<b>1273</b>	<b>596</b>
Frontal BYPASS <b>160</b>	148-158	65-75	<b>1274</b>	<b>612</b>



Rodamiento oculto 4 poleas

# BYPASS frontal + lateral fijo

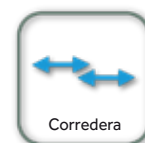

## Laterales fijos BYPASS

Descripción	Rango	Ref.	Puntos
Lateral fijo BYPASS <b>70</b>	66-69	<b>1275</b>	<b>257</b>
Lateral fijo BYPASS <b>80</b>	76-79	<b>1276</b>	<b>267</b>

## Combinaciones frontales BYPASS + lateral fijo

Medidas	Rangos	Referencias	Puntos	Medidas	Rangos	Referencias	Puntos
120x70	110-120/66-69	<b>1270 + 1275</b>	<b>805</b>	120x80	110-120/76-79	<b>1270 + 1276</b>	<b>815</b>
130x70	120-130/66-69	<b>1271 + 1275</b>	<b>821</b>	130x80	120-130/76-79	<b>1271 + 1276</b>	<b>831</b>
140x70	130-140/66-69	<b>1272 + 1275</b>	<b>838</b>	140x80	130-140/76-79	<b>1272 + 1276</b>	<b>848</b>
150x70	140-150/66-69	<b>1273 + 1275</b>	<b>853</b>	150x80	140-150/76-79	<b>1273 + 1276</b>	<b>863</b>
160x70	150-160/66-69	<b>1274 + 1275</b>	<b>869</b>	160x80	150-160/76-79	<b>1274 + 1276</b>	<b>879</b>

\*Las aperturas son las mismas que en los frontales.



## Laterales fijos a medida (más información en página 282)

Descripción	Referencias	Puntos	Cajonado
Lateral fijo a medida BYPASS hasta 40 cm	<b>1346</b>	<b>218</b>	<b>+21</b>
Lateral fijo a medida BYPASS desde 40 hasta 80 cm	<b>1318</b>	<b>297</b>	<b>+21</b>
Lateral fijo a medida BYPASS desde 80 hasta 120 cm	<b>1319</b>	<b>367</b>	<b>+21</b>

\*Plazo de entrega 15 días

## GIRO 360° 1 puerta giratoria



### COMBIA Frontal GIRO 360° 1 puerta

Medida	Apertura	Rango	Referencias	Puntos
100	46	102,6/107,6	1212+1250+1212+1253	415
105	48	107,6/112,6	1212+1251+1212+1253	420
110	51	112,6/117,6	1212+1252+1212+1253	425

\*Permite unión con laterales fijos STD en ambos lados rango mínimo +0,7 cm (ver pág. 64).  
Necesario kit accesorios ref. 1256, 120 puntos.



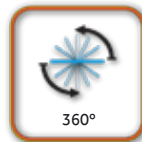

### COMBI B Frontal GIRO 360° 1 fijo + 1 puerta

Medidas	Fijo	Puerta	Apertura	Rango	Referencias	Puntos
120	20	100	46	117,5/122,5	1200+1250+1212+1254	475
125	25	100	46	122,5/127,5	1201+1250+1212+1254	483
125	20	105	48	122,5/127,5	1200+1251+1212+1254	480
130	30	100	46	127,5/132,5	1202+1250+1212+1254	491
130	25	105	48	127,5/132,5	1201+1251+1212+1254	488
130	20	110	51	127,5/132,5	1200+1252+1212+1254	485
135	30	105	48	132,5/137,5	1202+1251+1212+1254	496
135	25	110	51	132,5/137,5	1201+1252+1212+1254	493
140	40	100	46	137,5/142,5	1203+1250+1212+1254	507
140	30	110	51	137,5/142,5	1202+1252+1212+1254	501
145	40	105	48	142,5/147,5	1203+1251+1212+1254	512
150	50	100	46	147,5/152,5	1204+1250+1212+1254	523
150	40	105	48	147,5/152,5	1203+1252+1212+1254	517
155	50	100	46	152,5/157,5	1204+1251+1212+1254	528
160	60	100	46	157,5/162,5	1205+1250+1212+1254	538
160	50	110	51	157,5/162,5	1204+1252+1212+1254	533
165	60	105	48	162,5/167,5	1205+1251+1212+1254	543
170	60	110	51	167,5/172,5	1205+1252+1212+1254	548

\*Permite unión con laterales fijos STD en ambos lados rango mínimo +0,7 cm (ver pág. 64). Necesario kit accesorios ref. 1256, 120 puntos.

## GIRO 360° fijo + puerta + fijo



### COMBI C Frontal GIRO 360° fijo + puerta + fijo

Medidas	Apertura	Rango	Referencias	Puntos
135 (20+100+20)	46	132,6/137,6	1200+1250+1200+1255	550
140 (20+100+25)	46	137,6/142,6	1200+1250+1201+1255	558
140 (20+105+20)	48	137,6/142,6	1200+1251+1200+1255	555
145 (20+100+30)	46	142,6/147,6	1200+1250+1202+1255	566
145 (20+105+25)	48	142,6/147,6	1200+1251+1201+1255	563
145 (20+110+20)	51	142,6/147,6	1200+1252+1200+1255	560
145 (25+100+25)	46	142,6/147,6	1201+1250+1201+1255	566
150 (20+105+30)	48	147,6/152,6	1200+1251+1202+1255	571
150 (20+110+25)	51	147,6/152,6	1200+1252+1201+1255	568
150 (25+100+30)	46	147,6/152,6	1201+1250+1202+1255	574
150 (25+105+25)	48	147,6/152,6	1201+1251+1201+1255	571
155 (20+100+40)	46	152,6/157,6	1200+1250+1203+1255	582
155 (20+110+30)	51	152,6/157,6	1200+1252+1202+1255	576
155 (25+105+30)	48	152,6/157,6	1201+1251+1202+1255	579
155 (30+100+30)	46	152,6/157,6	1202+1250+1202+1255	582



## COMBI C Frontal GIRO 360° fijo + puerta + fijo

Medidas	Apertura	Rango	Referencias	Puntos
160 (20+105+40)	48	157,6/162,6	1200+1251+1203+1255	587
160 (25+100+40)	46	157,6/162,6	1201+1250+1203+1255	590
160 (30+105+30)	48	157,6/162,6	1202+1251+1202+1255	587
165 (20+100+50)	46	162,6/167,6	1200+1250+1204+1255	598
165 (20+110+40)	51	162,6/167,6	1200+1252+1203+1255	592
165 (25+105+40)	48	162,6/167,6	1201+1251+1203+1255	595
165 (30+100+40)	46	162,6/167,6	1202+1250+1203+1255	598
165 (30+110+30)	51	162,6/167,6	1202+1252+1202+1255	592
170 (20+105+50)	48	167,6/172,6	1200+1251+1204+1255	603
170 (25+100+50)	46	167,6/172,6	1201+1250+1204+1255	606
170 (30+105+40)	48	167,6/172,6	1202+1251+1203+1255	603
175 (20+100+60)	46	172,6/177,6	1200+1250+1205+1255	613
175 (20+110+50)	51	172,6/177,6	1200+1252+1204+1255	608
175 (25+105+50)	48	172,6/177,6	1201+1251+1204+1255	611
175 (30+100+50)	46	172,6/177,6	1202+1250+1204+1255	614
175 (30+110+40)	51	172,6/177,6	1202+1252+1203+1255	608
175 (40+100+40)	46	172,6/177,6	1203+1250+1203+1255	614
180 (20+105+60)	48	177,6/182,6	1200+1251+1205+1255	618
180 (25+100+60)	46	177,6/182,6	1201+1250+1205+1255	621
180 (30+105+50)	48	177,6/182,6	1202+1251+1204+1255	619
180 (40+105+40)	48	177,6/182,6	1203+1251+1203+1255	619
185 (20+110+60)	51	182,6/187,6	1200+1252+1205+1255	623
185 (25+105+60)	48	182,6/187,6	1201+1251+1205+1255	626
185 (30+100+60)	46	182,6/187,6	1202+1250+1205+1255	629
185 (30+110+50)	51	182,6/187,6	1202+1252+1204+1255	624
185 (40+100+50)	46	182,6/187,6	1203+1250+1204+1255	630
185 (40+110+40)	51	182,6/187,6	1203+1252+1203+1255	624
190 (30+105+60)	48	187,6/192,6	1202+1251+1205+1255	634
190 (40+105+50)	48	187,6/192,6	1203+1251+1204+1255	635
195 (30+110+60)	51	192,6/197,6	1202+1252+1204+1255	624
195 (40+100+60)	46	192,6/197,6	1203+1250+1205+1255	645
195 (40+110+50)	51	192,6/197,6	1203+1252+1205+1255	655
195 (50+100+50)	46	192,6/197,6	1204+1250+1204+1255	646
200 (50+105+50)	48	197,6/200	1204+1251+1204+1255	651
200 (40+105+60)	48	197,6/200	1203+1251+1205+1255	650

\*Permite unión con laterales fijos STD en ambos lados rango mínimo +0,7 cm (ver pág. 64).  
Necesario kit accesorios ref. 1256, 120 puntos.

# PUERTAS DE PASO CROMO

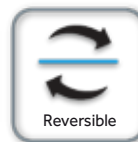

Descripción	Ref.	Puntos
Puerta de 75 cm + kit barra/guía 150 cm cromo	1750+1752	338
Puerta de 85 cm + kit barra/guía 170 cm cromo	1751+1753	357

PUERTAS A MEDIA Y ESPECIALES	
TRANSP.	MATE
+45%	+60%

\*Plazo de entrega 15 días

# PUERTAS DE PASO NEGRO

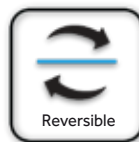

PUERTA PASO

Descripción	Ref.	Puntos
Puerta de 75 cm + kit barra/guía 150 cm negro	1750+1754	338
Puerta de 85 cm + kit barra/guía 170 cm negro	1751+1755	357

PUERTAS A MEDIA Y ESPECIALES	
TRANSP.	MATE
+45%	+60%

\*Plazo de entrega 15 días

OPEN pg.266 ●●

OPEN 2 pg.268

GLASS PLEG.





BAÑERA pg.269

FIJO SCREEN pg.270 ●●○●

BASIC pg.272 ●●○●



BAÑERA

# SOLUCIONES DE BAÑERA

# Open 1

## Abatibles bañera

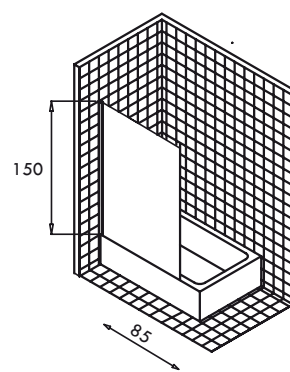
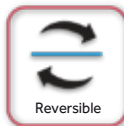

# Open 1

## Abatible de bañera 85x150

Descripción	Ref.	Puntos
Abatible 150x85 cm	0121	159

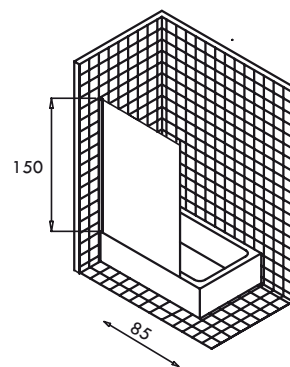

# Open 1 Frost Plus

## Abatible de bañera 85x150

Descripción	Ref.	Puntos
Abatible Frost Plus 150x85 cm	0123	175



H150

Altura



6mm

Grosor cristal



Abatible 180°



1.5cm

Expansión

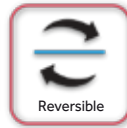

Reversible



aluminio  
**AL**  
aluminium



Clear shield glass

## Open 1 Black

Abatible de bañera 85x150



BAÑERA

Descripción	Ref.	Puntos
Abatible 150x85 cm	0121N	169



H150

Altura



6mm

Grosor cristal



Abatible 180°



2.5cm

Expansión

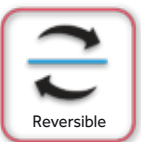

Reversible



aluminio  
AL  
aluminium



tratamiento  
antirain  
clear  
shield  
glass



## Open 2

Fijo + abatible 150x122

Descripción	Ref.	Puntos
Panel open 2 transparente	0120+0121	247

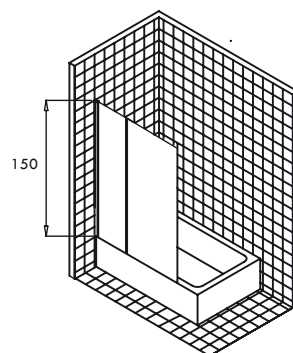

150

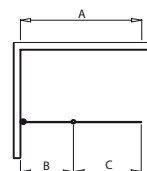

A	B	C
120	37	83

perfil aluminio cromo brillo  
vidrio templado 6mm  
elevación al girar

## Open 2 Frost Plus

Fijo + abatible 150x122

Descripción	Ref.	Puntos
Panel open 2 frost plus	0122+0123	271

# Glass plegable

Para bañera 95x150 cm



BAÑERA

Descripción	Ref.	Puntos
Glass plegable de bañera 94,5x150 cm (47+47)	1733	299



## Screen fijo de bañera 150x85



Descripción	Ref.	Puntos
Fijo 150x85 cm	<b>0118</b>	<b>159</b>

Incluye brazo orientable recto/45° ajustable 60-120 cm

## Screen Frost Plus



Descripción	Ref.	Puntos
Fijo Frost Plus 150x85 cm	<b>0119</b>	<b>194</b>

Incluye brazo orientable recto/45° ajustable 60-120 cm

## Screen Black



Descripción	Ref.	Puntos
Panel fijo Black 150x85 cm	<b>SC85N</b>	<b>199</b>

Incluye brazo orientable recto/45° ajustable 60-120 cm

## Screen Black Frost Plus



Descripción	Ref.	Puntos
Fijo Black Frost plus 150x85 cm	<b>SC85FN</b>	<b>253</b>

Incluye brazo orientable recto/45° ajustable 60-120 cm



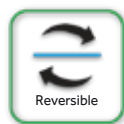

## Screen Gold



Descripción	Ref.	Puntos
Panel fijo Gold 150x85 cm	<b>SC85OR</b>	<b>246</b>

Incluye brazo orientable recto/45° ajustable 60-120 cm

## Screen Gold Frost Plus



Descripción	Ref.	Puntos
Fijo Gold Frost plus 150x85 cm	<b>SC85FOR</b>	<b>281</b>

Incluye brazo orientable recto/45° ajustable 60-120 cm

## Screen White



Descripción	Ref.	Puntos
Fijo White 150x85 cm	<b>SC85B</b>	<b>199</b>

Incluye brazo orientable recto/45° ajustable 60-120 cm

## Screen White Frost Plus



Descripción	Ref.	Puntos
Fijo White Frost Plus 150x85 cm	<b>SC85FB</b>	<b>253</b>

Incluye brazo orientable recto/45° ajustable 60-120 cm

# BASIC BAÑERA 1 fijo + 1 corredera



Pletina embellecedora



Doble rodamiento regulable en nylon con antivuelco



Nuevo guiador optimizado con pulsador liberador de hoja

## BASIC BAÑERA 1fijo + 1corredera

Medida	Apertura	TRANSPARENTE		FROST PLUS	
		Ref.	Puntos	Ref.	Puntos
140-145	56-61	5801	333	6801	349
145-150	61-66	5802	337	6802	356
150-155	61-66	5803	342	6803	360
155-160	61-66	5804	345	6804	366
160-165	61-66	5805	351	6805	369
165-170	66-71	5806	356	6806	375

Opción perfilería titanio +20 puntos.

Descripción	Referencias	Puntos
Perfil de compensación +1,5 cm	5429	25
Opción perfil unión fijo-fijo (indicar mano), ver pág. 167	0182	40
Pletina embellecedora 195x3,8 cm	0007	30



A MEDIDA  
Y ESPECIALES  
Ver pag. 280

# BASIC COLOR BAÑERA



FRONTAL PERFILERÍA NEGRA



FRONTAL PERFILERÍA BLANCA



Medida	Apert.	TRANSPARENTE			FROST PLUS		
		NEGRO	BLANCO	Puntos	NEGRO	BLANCO	Puntos
140-145	56-61	5801N	5801B	353	6801N	6801B	369
145-150	61-66	5802N	5802B	357	6802N	6802B	376
150-155	61-66	5803N	5803B	362	6803N	6803B	380
155-160	61-66	5804N	5804B	365	6804N	6804B	386
160-165	61-66	5805N	5805B	371	6805N	6805B	389
165-170	66-71	5806N	5806B	376	6806N	6806B	395

## Accesorios

Descripción
Perfil de compensación +1,5 cm
Pletina embellecedora 195x3,8 cm
Opción perfil unión fijo-fijo (indicar mano)

NEGRO	
Ref.	Puntos
5477	25
0007N	30
0991	40

BLANCO	
Ref.	Puntos
5473	25
0007B	30
0182B	40



A MEDIDA  
Y ESPECIALES  
Ver pag. 280

# BASIC BAÑERA + lateral fijo de 8 mm



H150 Altura	1-6 cm Cruce puertas
6mm Grosor cristal	Corredera
Reversible	aluminio AL aluminium
Tratamiento anticalcio clear shield glass	● Negro ○ Blanco ● Titanio Colores

## Laterales fijos bañera

Descripción	Rango
Lateral fijo BASIC 70x150	67-70
Lateral fijo BASIC 75x150	72-74

TRANSPARENTE	
Ref.	Puntos
5065	150
5066	170

FROST PLUS	
Ref.	Puntos
6065	155
6066	175

## combinaciones BASIC BAÑERA + lateral fijo de 8 mm

Medida	Rangos	Apertura
145x70	140-145/67-70	56-61
150x70	145-150/67-70	61-66
155x70	150-155/67-70	61-66
160x70	155-160/67-70	61-66
165x70	160-165/67-70	61-66
170x70	165-170/67-70	66-71
Medida	Rangos	Apertura
145x75	140-145/72-74	56-61
150x75	145-150/72-74	61-66
155x75	150-155/72-74	61-66
160x75	155-160/72-74	61-66
165x75	160-165/72-74	61-66
170x75	165-170/72-74	66-71

TRANSPARENTE	
Referencias	Puntos
5801+5065	483
5802+5065	487
5803+5065	492
5804+5065	495
5805+5065	501
5806+5065	506
Referencias	Puntos
5801+5066	503
5802+5066	507
5803+5066	512
5804+5066	515
5805+5066	521
5806+5066	526

FROST PLUS	
Referencias	Puntos
6801+6065	504
6802+6065	511
6803+6065	515
6804+6065	521
6805+6065	524
6806+6065	530
Referencias	Puntos
6801+6066	524
6802+6066	531
6803+6066	535
6804+6066	541
6805+6066	544
6806+6066	550

\*Opción perfil unión fijo-fijo ref. 0182 +40 puntos (indicar mano). Opción perfilera titanio +20 puntos.



## Laterales fijos a medida

Descripción
medida hasta 40 cm
medida de 40 hasta 80 cm
medida de 80 hasta 120 cm

TRANSPARENTE	
Ref.	Puntos
1350	206
1334	286
1335	356

FROST PLUS	
Ref.	Puntos
1350+1312	328
1334+1313	408
1335+1315	478

Cajonado
+21
+21
+21

\*Plazo de entrega 15 días

# BASIC COLOR BAÑERA + lateral fijo de 8 mm

FRONTAL PERFILERÍA NEGRA

FRONTAL PERFILERÍA BLANCA



## Laterales fijos bañera

Medida	Rango	TRANSPARENTE			FROST PLUS		
		NEGRO	BLANCO	Puntos	NEGRO	BLANCO	Puntos
Lateral fijo BASIC 70x150	67-70	5065N	5065B	235	6065N	6065B	240
Lateral fijo BASIC 75x150	72-74	5066N	5066B	255	6066N	6066B	260

Rango (frontal/lat.fijo)	TRANSPARENTE			FROST PLUS		
	NEGRO	BLANCO	Puntos	NEGRO	BLANCO	Puntos
140-145/67-70	5801N+5065N	5801B+5065B	588	6801N+6065N	6801B+6065B	609
145-150/67-70	5802N+5065N	5802B+5065B	592	6802N+6065N	6802B+6065B	616
150-155/67-70	5803N+5065N	5803B+5065B	597	6803N+6065N	6803B+6065B	620
155-160/67-70	5804N+5065N	5804B+5065B	600	6804N+6065N	6804B+6065B	626
160-165/67-70	5805N+5065N	5805B+5065B	606	6805N+6065N	6805B+6065B	629
165-170/67-70	5806N+5065N	5806B+5065B	611	6806N+6065N	6806B+6065B	635
Rango (frontal/lat.fijo)	NEGRO	BLANCO	Puntos	NEGRO	BLANCO	Puntos
140-145/72-74	5801N+5066N	5801B+5066B	608	6801N+6066N	6801B+6066B	629
145-150/72-74	5802N+5066N	5802B+5066B	612	6802N+6066N	6802B+6066B	636
150-155/72-74	5803N+5066N	5803B+5066B	617	6803N+6066N	6803B+6066B	640
155-160/72-74	5804N+5066N	5804B+5066B	620	6804N+6066N	6804B+6066B	646
160-165/72-74	5805N+5066N	5805B+5066B	626	6805N+6066N	6805B+6066B	649
165-170/72-74	5806N+5066N	5806B+5066B	631	6806N+6066N	6806B+6066B	655

\*Opción perfil unión fijo-fijo NEGRO ref. 0991 +40 puntos (indicar mano).

\*Opción perfil unión fijo-fijo BLANCO ref. 0182B +40 puntos (indicar mano).



## Laterales fijos a medida

Descripción	TRANSPARENTE		FROST PLUS		Cajonado
	Ref.	Puntos	Ref.	Puntos	
medida hasta 40 cm	1350N/B	216	1350N/B+1312	338	+21
medida de 40 hasta 80 cm	1334N/B	296	1334N/B+1313	418	+21
medida de 80 hasta 120 cm	1335N/B	366	1335N/B+1315	488	+21

\*Plazo de entrega 15 días

# BASIC SPAZIO BAÑERA 2 fijos + 2 correderas



Rango	Apertura	TRANSPARENTE		FROST PLUS	
		Ref.	Puntos	Ref.	Puntos
152-162	64-74	5810	413	6810	433
162-172	66-76	5811	423	6811	443
172-182	72-82	5812	431	6812	451

Opción perfilaría titanio +20 puntos.

Descripción	Referencias	Puntos
Perfil de compensación +1,5 cm	5429	25



A MEDIDA  
Y ESPECIALES  
Ver pag. 280



# BASIC SPAZIO COLOR BAÑERA



FRONTAL PERFILERÍA NEGRA



FRONTAL PERFILERÍA BLANCA



BAÑERA

Rango	Apert.	TRANSPARENTE			FROST PLUS		
		NEGRO	BLANCO	Puntos	NEGRO	BLANCO	Puntos
152-162	56-61	5810N	5810B	433	6810N	6810B	453
162-172	61-66	5811N	5811B	443	6811N	6811B	463
172-182	61-66	5812N	5812B	451	6812N	6812B	471

## Accesorios

Descripción	NEGRO		BLANCO	
	Ref.	Puntos	Ref.	Puntos
Perfil de compensación +1,5 cm	5477	25	5473	25
Pletina embellecedora 195x3,8 cm	0007N	30	0007B	30



A MEDIDA  
Y ESPECIALES  
Ver pag. 280

# BASIC SPAZIO BAÑERA + lateral fijo de 8 mm



H150 Altura	1-6 cm Cruce puertas
6mm Grosor cristal	Corredera
Reversible	aluminio AL aluminium
Tratamiento antical clear shield glass	● Negro ○ Blanco ● Titanio Colores

AL REALIZAR EL PEDIDO SE DEBE INDICAR LA MANO DÓNDE VA INSTALADO EL LATERAL FIJO

## Laterales fijos bañera

Descripción	Rango
Lateral fijo BASIC 70x150	67-70
Lateral fijo BASIC 75x150	72-74

TRANSPARENTE	
Ref.	Puntos
5065	150
5066	170

FROST PLUS	
Ref.	Puntos
6065	155
6066	175

## combinaciones frontales BASIC SPAZIO + lateral fijo de 8 mm

Medida	Rangos	Apertura
160x70	152-162/67-69	64-74
170x70	162-172/67-69	66-76
180x70	172-182/67-69	72-82
Medida	Rangos	Apertura
160x75	152-162/72-74	64-74
170x75	162-172/72-74	66-76
180x75	172-182/72-74	72-82

TRANSPARENTE	
Referencias	Puntos
5810+5065+0182	603
5811+5065+0182	613
5812+5065+0182	621
Referencias	Puntos
5810+5066+0182	623
5811+5066+0182	633
5812+5066+0182	641

FROST PLUS	
Referencias	Puntos
6810+6065+0182	628
6811+6065+0182	638
6812+6065+0182	646
Referencias	Puntos
6810+6066+0182	648
6811+6066+0182	658
6812+6066+0182	666

Se debe indicar lamano dónde va el lateral fijo.



## Laterales fijos a medida

Descripción
medida hasta 40 cm
medida de 40 hasta 80 cm
medida de 80 hasta 120 cm

TRANSPARENTE	
Ref.	Puntos
1350+0182	246
1334+0182	326
1335+0182	396

FROST PLUS	
Ref.	Puntos
1350+0182+1312	368
1334+0182+1312	448
1335+0182+1312	518

Cajonado
+21
+21
+21

Indicar mano dónde va el lateral fijo. Plazo de entrega 15 días.

# BASIC SPAZIO COLOR BAÑERA + lateral fijo de 8 mm

FRONTAL PERFILERÍA NEGRA



FRONTAL PERFILERÍA BLANCA



## Laterales fijos bañera

Medida	Rango
Lateral fijo BASIC 70x150	67-70
Lateral fijo BASIC 75x150	72-74

### TRANSPARENTE

NEGRO	BLANCO	Puntos
5065N	5065B	235
5066N	5066B	255

### FROST PLUS

NEGRO	BLANCO	Puntos
6065N	6065B	240
6066N	6066B	260

Rangos	TRANSPARENTE		Puntos
	NEGRO	BLANCO	
152-162/67-69	5810N+5065N+0991	5810B+5065B+0182B	708
162-172/67-69	5811N+5065N+0991	5811B+5065B+0182B	718
172-182/67-69	5812N+5065N+0991	5812B+5065B+0182B	726
Rangos	NEGRO	BLANCO	Puntos
152-162/72-74	5810N+5066N+0991	5810B+5066B+0182B	728
162-172/72-74	5811N+5066N+0991	5811B+5066B+0182B	738
172-182/72-74	5812N+5066N+0991	5812B+5066B+0182B	746

Rangos	FROST PLUS		Puntos
	NEGRO	BLANCO	
152-162/67-69	6810N+6065N+0991	6810B+6065B+0182B	733
162-172/67-69	6811N+6065N+0991	6811B+6065B+0182B	743
172-182/67-69	6812N+6065N+0991	6812B+6065B+0182B	751
Rangos	NEGRO	BLANCO	Puntos
152-162/72-74	6810N+6066N+0991	6810B+6066B+0182B	753
162-172/72-74	6811N+6066N+0991	6811B+6066B+0182B	763
172-182/72-74	6812N+6066N+0991	6812B+6066B+0182B	771

Se debe indicar lamano dónde va el lateral fijo.

## Laterales a medida

Descripción	TRANSPARENTE		Puntos
	NEGRO	BLANCO	
medida hasta 40 cm	1350N+0991	1350B+0182B	256
medida de 40 hasta 80 cm	1334N+0991	1334B+0182B	336
medida de 80 hasta 120 cm	1335N+0991	1335B+0182B	406

Descripción	FROST PLUS		Puntos
	NEGRO	BLANCO	
medida hasta 40 cm	1350N+0991+1312	1350B+0182B+1312	378
medida de 40 hasta 80 cm	1334N+0991+1313	1334B+0182B+1313	458
medida de 80 hasta 120 cm	1335N+0991+1315	1335B+0182B+1315	528

Indicar mano dónde va el lateral fijo. Plazo de entrega 15 días. Cajonado +21 puntos.

# MAMPARAS CORREDERAS A MEDIDA Y ESPECIALES

Futura Rotary Temple Basic Vitro Twenty

**MAMPARAS A MEDIDAS TRANSPARENTES**

- Para el cálculo del punto se incrementará un 45% al punto de la referencia que cubra ese rango o la inmediatamente superior.
- Indicar Modelo / Referencia / Medida.
- No se aceptan medidas de ancho superiores a la mayor de la tabla, excepto Basic hasta 220 cm de alto.

**Ref. 0868**

**+45%**

ALTURA  
195 cm

**SOLO MODELO  
BASIC CROMO**

**Ref. 0871**

**+75%**

ALTURA  
196 a 220 cm

**MAMPARAS A MEDIDA ACABADOS ESPECIALES**

Acabado **FROST PLUS ÁCIDO, PARSOL, CARGLASS / MATE**

- Para el cálculo del punto se incrementará un 60% al punto de la referencia que cubra ese rango o la inmediatamente superior.
- Es necesario indicar la posición de la puerta y el fijo.
- Indicar Modelo / Referencia / Medida.
- No se aceptan medidas de ancho superiores a la mayor de la tabla, excepto Basic hasta 220 cm de alto.

**Ref. 0870**

**+60%**

ALTURA  
195 cm

**SOLO MODELO  
BASIC CROMO**

**Ref. 0872**

**+90%**

ALTURA  
196 a 220 cm

## ACABADOS ESPECIALES:



**FROST PLUS**



**PARSOL BRONCE**

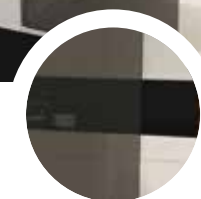

**PARSOL FUMÉ**



**MATE**

**PLAZO MEDIO DE ENTREGA 15 DÍAS** (No se aceptarán devoluciones ni anulaciones de cristales a medida)

# MAMPARAS ABATIBLES A MEDIDA

Glass Open Glass Plegable

## PANELES FIJOS

MODELO
PANEL FIJO <b>OPEN</b> 6 mm
PANEL FIJO <b>OPEN NEGRO</b> 6 mm
PANEL FIJO <b>GLASS</b> 8 mm

Incluye perfilería y herrajes.  
No incluye brazo Open ni Glass

Ancho < 40 cm	
Ref.	Punto
1345	175
1345N	207
1339	385

Ancho > 40 y < 80 cm	
Ref.	Punto
1316	250
1316N	282
1336	435

Ancho > 80 y < 120 cm	
Ref.	Punto
1317	320
1317N	372
1337	550

## PUERTAS

MODELO
PUERTA <b>GLASS / GLASS PLEGABLE</b>

Ancho < 80 cm	
Ref.	Punto
1338	150



OPEN



GLASS



GLASS PLEGABLE

## PERFILERÍA Y HERRAJES

Ref.: 1735 | Descripción: perfilería y herrajes para fijo Glass a medida | Puntos: 160

Ref.: 1736 | Descripción: perfilería y herrajes para puerta Glass a medida | Puntos: 50

\*Incluye todo excepto el cristal

**PLAZO MEDIO DE ENTREGA 15 DÍAS** (No se aceptarán devoluciones ni anulaciones de cristales a medida)

# LATERALES FIJOS A MEDIDA

MODELO	Ancho <40 cm		Ancho >40 y <80 cm		Ancho >80 y <120 cm	
	Ref.	Punto	Ref.	Punto	Ref.	Punto
Lateral Fijo 8 mm VETRUM	1340	305	1300	390	1306	460
Lateral Fijo 8 mm MOVING	1341	305	1301	390	1307	460
Lateral Fijo 8 mm TEMPLE	1349	206	1302	286	1308	356
Lateral Fijo 6 mm TRIO	1342	206	1303	286	1309	356
Lateral Fijo 6 mm BYPASS	1346	218	1318	297	1319	367
Lateral Fijo 8 mm FUTURA	1347	229	1330	309	1331	379
Lateral Fijo 8 mm ROTARY	1348	206	1332	286	1333	356
Lateral Fijo 8 mm BASIC hasta 195 cm	1350	206	1334	286	1335	356
Lateral Fijo 8 mm BASIC 195 hasta 220 cm	1350H2	256	1334H2	336	1335H2	406
Lateral Fijo 8 mm BASIC NEGRA	1350N	216	1334N	296	1335N	366
Lateral Fijo 8 mm BASIC BLANCA	1350B	216	1334B	296	1335B	366
Lateral Fijo 8 mm BASIC	1350T	236	1334T	316	1335T	386
*Lateral fijo 6 mm OPEN / GLASS / GLASS PLEGABLE	1345	175	1316	250	1317	320
*Lateral fijo 6 mm OPEN NEGRO	1345N	207	1316N	282	1317N	352
Lateral fijo 8 mm VITRO	1351	242	1352	320	1353	390
Lateral fijo 8 mm KENNA	1365	279	1366	364	1367	434
Lateral fijo 6 mm TWENTY CROMO	1375	212	1376	291	1377	361
Lateral fijo 6 mm TWENTY BLACK	1375N	217	1376N	296	1377N	366
Lateral fijo 6 mm TWENTY GOLD	1375OR	237	1376OR	316	1377OR	388
*Fijo STD 8 mm AKTUAL / PRESTIGE / AKORD / OPEN / GLASS / GLASS PLEGABLE / GIRO	1343	175	1304	250	1310	320
*Fijo STD NEGRO 8 mm	1343N	175	1304N	250	1310N	320

\*No incluye brazo

Incremento acabado FROST PLUS	1312	+122	1313	+122	1315	+122
-------------------------------	------	------	------	------	------	------

\*Indicar la posición del lateral

Incremento acabado PARSOL	Ref. 0870SC - Puntos Laterales fijos a medida +35%
---------------------------	--

## CAJONADO

Ref.: 0862 | Descripción: Corte escuadra/Cajonado  
Puntos: 21

\*Excepto Vetrum, Kenna, Prestigetitan, Aktual, Glass plegable y Bypass.

(Medida total incluido el perfil)

En caso de llevar cajonado, indique ubicación

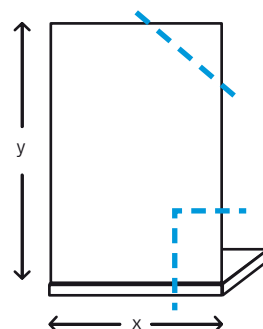
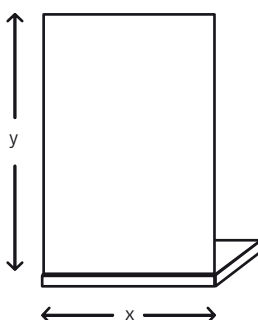

**PLAZO MEDIO DE ENTREGA 15 DÍAS** (No se aceptarán devoluciones ni anulaciones de cristales a medida)



# SCREEN CROMO A MEDIDA

Descripción	Ref.	Puntos
Ancho < 80 cm Altura hasta 195 cm	1305	276
Ancho < 80 cm Altura de 195 hasta 220 cm	1363	350

Descripción	Ref.	Puntos
Ancho de 80 a 120 cm Altura hasta 195 cm	1311	350
Ancho de 80 a 120 cm Altura de 195 hasta 220 cm	1364	450

Estos precios incluyen todos los componentes para su montaje excepto el brazo en el modelo Screen.

Incremento FROST PLUS ancho < 80 cm	1313	122
-------------------------------------	------	-----

Incremento FROST PLUS ancho 80-120 cm	1315	122
---------------------------------------	------	-----

Plazo de entrega 15 días.

Descripción	Ref.	Puntos
Corte Escuadra/Cajonado	0862	21

(Medida total incluido el perfil)

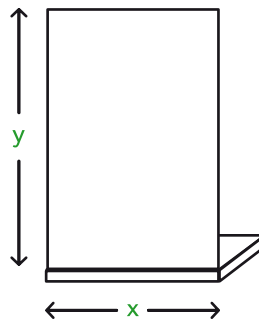

En caso de llevar cajonado, indique medidas

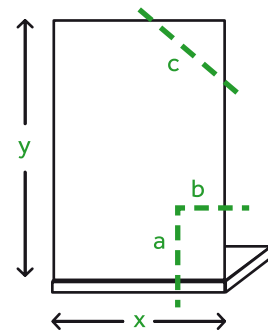

## SCREEN móvil bisagras 180° a medida

Descripción	TRANSPARENTE		FROST PLUS	
	Ref.	Puntos	Ref.	Puntos
Hasta 40 cm	1355	206	1357	312
de 40 a 80 cm	1356	271	1358	411
Altura 195 a 220 cm	1355H2	350	1357H2	460

Estos precios incluyen todos los componentes para su montaje.

Plazo de entrega 15 días.

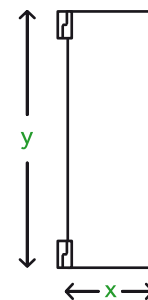

### ACABADOS PARSOL EN SCREEN/LATERALES FIJOS A MEDIDA 8 mm

Ref. 0870SC - Puntos Screen a medida +35%



FROST PLUS

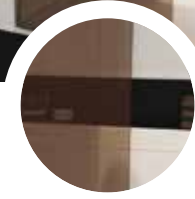

PARSOL BRONCE



PARSOL FUMÉ



MATE

A MEDIDA

**PLAZO MEDIO DE ENTREGA 15 DÍAS** (No se aceptarán devoluciones ni anulaciones de cristales a medida)

## TUBOS COMPENSACIÓN MONTAJE (INCLUYE TAPA Y HERRAJES)

Descripción	Referencias	Puntos
Tubo compensación 40x20x2000 mm cromo	0001	33
Tubo compensación 40x40x2000 mm cromo	0002	38
Tubo compensación 40x40x2000 mm negro mate	0002N	38
Tubo compensación 40x40x2000 mm blanco	0002B	38
Tubo compensación 40x60x2000 mm cromo	0003	43
Ángulo 30x30x2000 mm cromo	0004	28
Tubo compensación INOX 40x20x2000 mm	0009	60
Tubo compensación INOX 40x40x2000 mm	0010	90

## PERFILERÍA Y HERRAJES PARA LATERALES FIJOS A MEDIDA

Descripción	Referencias	Puntos
Perfilería y herrajes para fijos STD a medida	0821	59
Perfilería y herrajes para fijos STD NEGRO a medida	9023	59
Perfilería y herrajes para fijos TEMPLE a medida	5128	75
Perfilería y herrajes para fijos TRIO a medida	0006	102
Perfilería y herrajes para fijos SCREEN a medida	0822	27
Perfilería y herrajes para fijos SCREEN BLACK a medida	0822N	37
Perfilería y herrajes para fijos SCREEN WHITE a medida	0822B	37
Perfilería y herrajes para fijos SCREEN GOLD a medida	0822OR	47
Perfilería y herrajes para fijos MOVING a medida	1081	153
Perfilería y herrajes para fijos VETRUM a medida	1080	133
Perfilería y herrajes para fijos OPEN a medida	0824	53
Perfilería, herrajes y brazo para fijos OPEN BLACK a medida	9022	85
Perfilería y herrajes para fijos BYPASS a medida	1277	116
Perfilería y herrajes para fijos ROTARY a medida	5228	78
Perfilería y herrajes para fijos FUTURA a medida	5328	112
Perfilería y herrajes para fijos BASIC a medida	5428	78
Perfilería y herrajes para fijos BASIC NEGRA a medida	5492	85
Perfilería y herrajes para fijos BASIC BLANCA a medida	5588	85
Perfilería y herrajes para fijos BASIC TITANIO a medida	5567	105
Perfilería y herrajes para fijos KENNA a medida	6552	110
Perfilería y herrajes para fijos TWENTY a medida	2025	80
Perfilería y herrajes para fijos TWENTY NEGRA a medida	2026	85
Perfilería y herrajes para fijos TWENTY ORO a medida	2027	95

\*Incluye todo excepto el cristal

## HERRAJES PARA ABATIBLES DE BISAGRAS SCREEN A MEDIDA

Descripción	Referencias	Puntos
Kit bisagras SCREEN CROMO	0330	80
Kit bisagras SCREEN BLACK	0330NE	90
Kit bisagras SCREEN WHITE	0330BE	90
Kit bisagras SCREEN GOLD	0330OE	100

\*Incluye todo excepto el cristal

# OPCIONES MAMPARAS



**REF. 1731 / 1732 TIRADOR EXTRAPLANO:** Gana 7 cm de paso de entrada en medidas intermedias y 2 cm en el resto.



**REF. 1221 IMÁN DE EXPANSIÓN +1,2 OPEN:** juego de imanes magnéticos más anchos que permiten aumentar el rango de la combinación +1,2 cm.



**REF. 1072 OPCIÓN CIERRE PERFIL+JUNTA BURBUJA:** Sistema de cierre con perfil en "U" a pared y goma anti golpes en puerta "C".



**REF. 0007 EMBELLECEDOR ALUMINIO TRIO/BASIC:** Pletina de aluminio pulido para cubrir el espacio entre el límite del plato y el perfil de cierre. Se usa cuando la cerámica es distinta en el interior de la mampara. Dimensiones 195x3,8 cm.



**REF. 0008 EMBELLECEDOR ACERO FUTURA/ROTARY/TEMPLE:** Pletina de acero pulido para cubrir el espacio entre el límite del plato y el perfil de cierre. Se usa cuando la cerámica es distinta en el interior de la mampara. Dimensiones 195x3,8 cm.



**REF. 1222 PERFIL EXPANSIÓN PUERTA OPEN:** Perfil en forma de H que se usa como compensación del perfil de las puertas Open y Glass plegable. La ref. 1222 también hace posible la unión del perfil de la puerta a los laterales fijos STD.



**REF. 1215 PERFIL PUERTA OPEN:** sustituyendo el perfil 1211 por este perfil se reduce hasta 1 cm el rango de la combinación.

**REF. 1075 PERFIL UNIÓN FIJO+LATERAL FIJO:** En **Vetrum** y **Moving** permite la instalación del lateral fijo al fijo del frontal en lugar de a la puerta (foto). Solo válido para laterales fijos a medida, si se aplica para un lateral fijo de serie perderá 5 cm de rango.

En **Temple/Rotary/Basic** no altera ni las referencias ni los rangos de la combinación puerta-fijo, por lo que solo se deberá indicar la posición dónde va a instalarse el fijo. En serie **Screen** permite unir 2 fijos al vértice.

# RECAMBIOS MAMPARAS

En el siguiente código QR os mostramos los despieces de los distintos formatos de nuestras mamparas, separados por modelos, para facilitar la identificación de la pieza que necesita



**GME BASIC TITANIO**

**1FUJO+2CORREDERAS**      **FRONTAL+LAE FIJO**

**2FUJOS+2CORREDERAS**      **FREE**

**FIJO+CORREDERAS+FIJO**      **ANGULAR AL VÉRTICE**

**REPUESTOS**

**GME BASIC TITANIO 1F+1C**

Ref.	Imagen	Q	Ref.	Imagen	Q	Ref.	Imagen	Q	Ref.	Imagen	Q
8400		1	8401		1	8402		1	8403		1
8404		1	8405		1	8406		1	8407		1
8408		1	8409		1	8410		1	8411		1
8412		1	8413		1	8414		1	8415		1
8416		1	8417		1	8418		1	8419		1
8420		1	8421		1	8422		1	8423		1

**REPUESTOS**

**GME BASIC TITANIO SPAZIO 2F+2C**

Ref.	Imagen	Q	Ref.	Imagen	Q	Ref.	Imagen	Q	Ref.	Imagen	Q
8424		1	8425		1	8426		1	8427		1
8428		1	8429		1	8430		1	8431		1
8432		1	8433		1	8434		1	8435		1
8436		1	8437		1	8438		1	8439		1
8440		1	8441		1	8442		1	8443		1
8444		1	8445		1	8446		1	8447		1
8448		1	8449		1	8450		1	8451		1
8452		1	8453		1	8454		1	8455		1

**REPUESTOS**

**GME BASIC TITANIO**

**BASIC 1F+1C + LAE FIJO**      **BASIC 1F+1C FREE**

**A**      **B**

Ref.	Imagen	Q	Ref.	Imagen	Q	Ref.	Imagen	Q	Ref.	Imagen	Q
8456		1	8457		1	8458		1	8459		1
8460		1	8461		1	8462		1	8463		1
8464		1	8465		1	8466		1	8467		1
8468		1	8469		1	8470		1	8471		1
8472		1	8473		1	8474		1	8475		1
8476		1	8477		1	8478		1	8479		1
8480		1	8481		1	8482		1	8483		1
8484		1	8485		1	8486		1	8487		1
8488		1	8489		1	8490		1	8491		1
8492		1	8493		1	8494		1	8495		1

**REPUESTOS**

**GME BASIC TITANIO ANGULAR 2F+2C**

Ref.	Imagen	Q	Ref.	Imagen	Q	Ref.	Imagen	Q	Ref.	Imagen	Q
8496		1	8497		1	8498		1	8499		1
8500		1	8501		1	8502		1	8503		1
8504		1	8505		1	8506		1	8507		1
8508		1	8509		1	8510		1	8511		1
8512		1	8513		1	8514		1	8515		1
8516		1	8517		1	8518		1	8519		1
8520		1	8521		1	8522		1	8523		1
8524		1	8525		1	8526		1	8527		1
8528		1	8529		1	8530		1	8531		1
8532		1	8533		1	8534		1	8535		1
8536		1	8537		1	8538		1	8539		1
8540		1	8541		1	8542		1	8543		1
8544		1	8545		1	8546		1	8547		1
8548		1	8549		1	8550		1	8551		1
8552		1	8553		1	8554		1	8555		1
8556		1	8557		1	8558		1	8559		1
8560		1	8561		1	8562		1	8563		1
8564		1	8565		1	8566		1	8567		1
8568		1	8569		1	8570		1	8571		1
8572		1	8573		1	8574		1	8575		1
8576		1	8577		1	8578		1	8579		1
8580		1	8581		1	8582		1	8583		1
8584		1	8585		1	8586		1	8587		1
8588		1	8589		1	8590		1	8591		1
8592		1	8593		1	8594		1	8595		1
8596		1	8597		1	8598		1	8599		1
8600		1	8601		1	8602		1	8603		1
8604		1	8605		1	8606		1	8607		1
8608		1	8609		1	8610		1	8611		1
8612		1	8613		1	8614		1	8615		1
8616		1	8617		1	8618		1	8619		1
8620		1	8621		1	8622		1	8623		1
8624		1	8625		1	8626		1	8627		1
8628		1	8629		1	8630		1	8631		1
8632		1	8633		1	8634		1	8635		1
8636		1	8637		1	8638		1	8639		1
8640		1	8641		1	8642		1	8643		1
8644		1	8645		1	8646		1	8647		1
8648		1	8649		1	8650		1	8651		1
8652		1	8653		1	8654		1	8655		1
8656		1	8657		1	8658		1	8659		1
8660		1	8661		1	8662		1	8663		1
8664		1	8665		1	8666		1	8667		1
8668		1	8669		1	8670		1	8671		1
8672		1	8673		1	8674		1	8675		1
8676		1	8677		1	8678		1	8679		1
8680		1	8681		1	8682		1	8683		1
8684		1	8685		1	8686		1	8687		1
8688		1	8689		1	8690		1	8691		1
8692		1	8693		1	8694		1	8695		1
8696		1	8697		1	8698		1	8699		1
8700		1	8701		1	8702		1	8703		1
8704		1	8705		1	8706		1	8707		1
8708		1	8709		1	8710		1	8711		1
8712		1	8713		1	8714		1	8715		1
8716		1	8717		1	8718		1	8719		1
8720		1	8721		1	8722		1	8723		1
8724		1	8725		1	8726		1	8727		1
8728		1									

# MEDIDAS Y PRECIOS DE PERFILERÍA (cm)

## PERFILES VERTICALES DE PARED DEL FIJO

AKTUAL / PRESTIGE AKORD/GLASS	VETRUM	MOVING	FUTURA / TEMPLE ROTARY	BASIC VITRO	OPEN GIRO	KENNA
PA3F / PA3U / 26p / 26p	VE12 / 36p	MO17 / 36p	FTR3 / 36p	B03C* / 28p	OP4C* / 29p	K040 / 30p
TWENTY	SCREEN CROMO	SCREEN BLACK/WHITE	SCREEN GOLD			
TW30C* / 28p	S01C* / 19p	5477 / 5473 / 28p	S01OR / 35p			

## PERFILES VERTICALES DE PARED DEL CIERRE DE LA PUERTA







VETRUM MOVING	FUTURA	BASIC / TEMPLE ROTARY	OPEN	TRIO	BYPASS	PRESTIGE	KENNA
VE11 / 28p	F007 / 38p	B07C* / 38p	R195C* / 14p	TR20 / TR19 33p / 29p	BY12 / 65p	PA05 / 56p	K040 / 30p

## PERFILES HORIZONTALES SUPERIORES





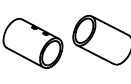

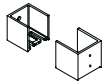

ROTARY	TEMPLE	BASIC	FUTURA	BYPASS	TRIO
Alto 3,8 Ancho 0,8	Alto 4,2 Ancho 1,3	Alto 4,8 Ancho 2,3	Alto 2,5 Ancho 3,1	Alto 4 Ancho 6	Alto 5,7 Ancho 5,7
RO21C180 / 107p	TE21C180 / 107p	B21C*210 / 85p	F21C210 / 105p	BY74 / 103p	TR246 / 111p
AKTUAL PRESTIGE	MOVING	TWENTY	PUERTA DE PASO		
Alto 4,5 Ancho 2	Ø2,5	Alto 2 Ancho 3,1			
A599 / 70p	MO180 / 150p	TW190C* / 82p	PP85C* / 85p	PP8C* / 65p	

\*Si el repuesto que desea solicitar es de color (negro, blanco, oro o titanio) consulte el PDF de "recambios" accediendo desde la página 286.



## SOPORTES DE PARED

ROTARY	TEMPLE	BASIC	FUTURA	MOVING	BYPASS	TRIO
						
Alto 4,5 Ancho 3,3	Alto 5,4 Ancho 3,8	Alto 5,8 Ancho 5,2	Alto 3,5 Ancho 6	Ø3	Alto 5,4 Ancho 7	Alto 6,2 Ancho 6,6
RO14 / 18p	TE14 / 18p	B15C* / 18p	F15 / 18p	MO09 / 16p	BY09 / 20p	TR8 / 20p





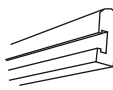

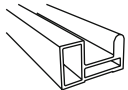
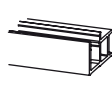

## PERFILES HORIZONTALES INFERIORES (VIERTEAGUAS METÁLICOS)

FUTURA/TEMPLE ROTARY/BASIC/GLASS	MOVING GIRO	BYPASS	TRIO	AKTUAL	VETRUM	OPEN	GLASS PLEGABLE
							
1x0,6 cm	0,9x0,9 cm	1,6x1,1 cm	1,1x1 cm	0,8x1,2 cm	1,8x0,8 cm	0,6x0,6 cm	1x0,5 cm
B12C*210 / 19p	MO15 / 28p	BY07 / 28p	TR1395 / 16p	A011 / 19p	VE08 / 68p	OP6C* / 16p	GP08 / 16p



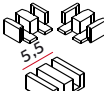

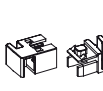
## PERFILES HORIZONTALES INFERIORES

VITRO	TWENTY (frontal)	TWENTY (vértice y spazio)	KENNA
			
1x2,3 cm	1,6x0,9 cm	1,6x0,9 cm	1,6x2,9 cm
VI14 210 / 80p	TW2C* / 16p	TW44C* / 38p	K120 / 65p

## GUÍAS INFERIORES

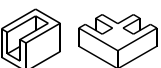
FUTURA	TEMPLE/BASIC ROTARY	MOVING	AKTUAL	VETRUM	BYPASS	TRIO	TWENTY	PTA. PASO	VITRO
									
F011 / 37p	G10C* / 37p	MO14 / 28p	A009 / 13p	VE07 31p	BY5 / BY08 13p / 41p	TR12 28p	TW14C* / TW15C* 16p / 16p	PP9C* / 8p	VI29 / 12p

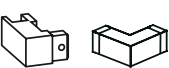
## CANTONERAS INFERIORES

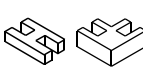
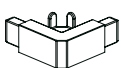
FUTURA/ROTARY TEMPLE/BASIC	MOVING	VETRUM	TRIO	OPEN	GLASS	TWENTY
						
B29C* / B42C* 12p / 12p	MO22 / 16p	VE44 / VE90 16p / 16p	TR37 / 12p	OP3C* / 8p	G009 / G011 / 10p / 10P	TW43C* / 16p

\*Si el repuesto que desea solicitar es de color (negro, blanco, oro o titanio) consulte el PDF de "recambios" accediendo desde la página 286.





## GOMAS

### GOMAS DE CIERRE BURBUJA



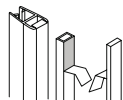



FUTURA/ROTARY/ TEMPLE/BASIC/TRIO

B006 / 8p

### GOMAS DE IMAN ADHESIVAS







FUTURA/ROTARY/ TEMPLE/BASIC/TRIO

B027 / B66C* / B65C* / 12p / 15p / 12p

KENNA

K220 / 21p









### GOMAS DE CIERRE DE IMÁN

FUTURA / TEMPLE BASIC	VETRUM	MOVING	AKTUAL /PRESTIGE	OPEN / GLASS / GIRO	KENNA	TWENTY
						
B036 / 16p	VE14 / 21p	MO20 / 19p	A017 / A007 13p / 13p	OP2C* / 16p	K180 / 16p	TW10 / 16p







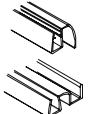

### GOMAS VIERTEAGUAS VERTICALES

FUTURA /ROTARY/TEMPLE BASIC/GLASS/TWENTY	VETRUM	MOVING	AKTUAL/PRESTIGE	AKORD	KENNA	
			 8/6mm			
B005 / 12p	VE19 / 16p	MO19 / 17p	A006 / A008 8p / 10p	AK06 / 18p	K070 / 10p	K080 / 12p



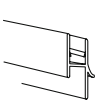







### GOMAS DE PRESIÓN

FUTURA /ROTARY TEMPLE / BASIC	VETRUM	MOVING	AKTUAL	SCREEN	OPEN/GLASS	KENNA	TWENTY
							
B004 / 8p	VE15 / 8p	MO18 / 8p	A013 / 8p	S002 / 8p	OP05 / 8p	K050 / 8p	TW08 / 8p





### GOMAS VIERTEAGUAS INFERIORES

FUTURA/ROTARY TEMPLE / BASIC	TRIO	MOVING	AKTUAL	BYPASS	OPEN GLASS	PANEL OPEN	PANEL GLASS	KENNA
								
B011 / 12p	TR28 / TR11 12p / 16p	MO21 12p	A010 / 12p	BY06 / 12p	OP07 / 12p	GB06 / 12p	G012 / 12p	K150 / 12p

### FRENOS DE PUERTA



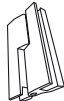



FUTURA	ROTARY	TEMPLE	MOVING	BASIC	AKTUAL PRESTIGE	VITRO	KENNA	TWENTY	PTA. PASO
								 SOFT CLOSE	
F019 / 12p	RO15 / 12p	TE15 / 7p	M010 / 18p	B22C* / 7p	PA1 / 5p	VI13 / 10p	K290 / 10p	TW28 / 26p	PP11 / 12p

### BISAGRAS



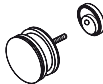

GLASS	GLASS PLEGABLE	SCREEN BISAGRA	SCREEN/OPEN	AKORD
				
HG07 / 42p	HM03 / 42p	S31C* / 42p	HU01C* / 17p	AK21 / 23p

\*Si el repuesto que desea solicitar es de color (negro, blanco, oro o titanio) consulte el PDF de "recambios" accediendo desde la página 286.



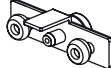

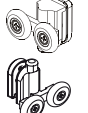

RODAMIENTOS (PUNTOS POR UNIDAD)

FUTURA	ROTARY	TEMPLE	VETRUM	MOVING	VITRO	AKTUAL / BASIC
						
F014 / 30p	RO13 / 28p	TE13 / 23p	VE10 / 35p	MO12 / 45p	VI15 / 26p	B013 / 15p

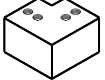

RODAMIENTOS (PUNTOS POR UNIDAD)

KENNA	TWENTY	PRESTIGE	AKORD	BYPASS	PTA. DE PASO	
						
K300 / 26p	TW25C* / 16p	TW45C* / 26p	P010 / P007 15p / 15p	AK19 / 17p	BY11 / 26p	PP04 / 17p

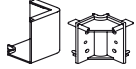
CANTONERAS SUPERIORES (ENTRADA AL VÉRTICE)

FUTURA	ROTARY	TEMPLE	MOVING	BASIC	TWENTY	AKTUAL PRESTIGE
						
F022 / 23p	RO25 / 23p	TE25 / 23p	MO23 / 20p	B25C* / 23p	TW27C* / 16p	PA 17 / PA16 / 10p / 10p

CANTONERAS DE LATERAL FIJO

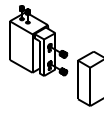
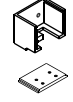
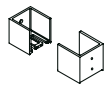
ROTARY	TEMPLE	BASIC	BYPASS	TRIO
				
RO44 / RO31 / 26p	TE44 / TE31 / 26p	B44C* / B31C* / 26p	BY16 / 35p	TR8 / 20p

TOPES DE GUÍA (PUNTOS POR UNIDAD)

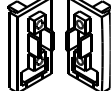
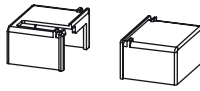
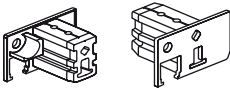
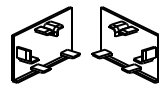
AKTUAL / PRESTIGE	KENNA	TWENTY	PTA. DE PASO
			
PA02 / 8p	K09 / 10p	TW24C* / 10p	PP10C* / 16p

TIRADORES

ROTARY / TEMPLE / BASIC GLASS / FUTURA / AKTUAL PRESTIGE / VITRO	MOVING	VETRUM	BYPASS	TRIO	KENNA	TWENTY	PTA. DE PASO	OPEN
								
22x2,5 cm	21x4 cm	42x2 cm	22x1 cm	28x3 cm	22x4,5 cm	22,5x3 cm		28x3 cm
T22C* / 23p	MO13 23p	VE06 35p	BY04 23p	T28C 25p	K200 23p	TW29C* 23p	PP6C* 48p	T28C* 23p

\*Si el repuesto que desea solicitar es de color (negro, blanco, oro o titanio) consulte el PDF de "recambios" accediendo desde la página 286.

REPUESTOS	OPEN	OPEN FROST	OPEN BLACK	GLASS	GLASS PLEGABLE
Cristal Fijo lado de 20	99			109	150
Cristal Fijo lado de 25	104			114	160
Cristal Fijo lado de 30	109	124	119	119	170
Cristal Fijo lado de 40	118	133	128	128	180
Cristal Fijo lado de 50	130	145	140	140	190
Cristal Fijo lado de 60	138	153	148	148	
Puerta de 30				115	115
Puerta de 35				119	119
Puerta de 40	160			122	122
Puerta de 45	170			125	125
Puerta de 50	180	200	190	127	127
Puerta de 55	190	210	200		
Puerta de 60	200	220	210		
Puerta de 65	210	230	220	142	142
Puerta de 70	215	235	225	146	146
Puerta de 75	220	240	230		
Puerta de 80	225	245	235	158	158
Puerta de 85	234	254	244		

REPUESTOS TRIO	FIJO	INTERM.	PUERTA
Frontal de 90	92	78	80
Frontal de 95	95	81	83
Frontal de 100	98	84	87
Frontal de 105	101	88	90
Frontal de 110	104	92	94
Frontal de 115	107	95	97
Frontal de 120	111	98	100
Frontal de 125	114	101	103
Frontal de 130	117	104	106
Frontal de 135	120	107	110
Frontal de 140	123	111	113
Frontal de 145	126	114	116
Frontal de 150	130	117	119
Frontal de 155	133	120	122
Frontal de 160	136	123	125
Rodamientos Trio		22	24

RECAMBIOS BYPASS	Puntos
Puerta Bypass 120	141
Puerta Bypass 130	147
Puerta Bypass 140	154
Puerta Bypass 150	160
Puerta Bypass 160	166

## RECAMBIOS CRISTALES FIJO / CORREDERA / LATERAL FIJO

	FUTURA/ROTARY TEMPLE/BASIC/ VITRO		VETRUM	MOVING	AKTUAL		PRESTIGE		KENNA	TWENTY
	TRANSP	F.PLUS	TRANSP	TRANSP	TRANSP	F.PLUS	TRANSP	F.PLUS	TRANSP	TRANSP
Cristal Fijo lado de 70	64	79	218	147	105	120	91	106		100
Cristal Fijo lado de 75	71	86					93	108		110
Cristal Fijo lado de 80	71	86	224	156	114	129	95	110		120
Cristal Fijo lado de 90	75	90	230	164	127	142	100	115		130
Cristal Fijo lado de 100	84	99	235	173	136	151	105	120		140
Cristal Fijo lado de 110	90	104	241	180	149	164	109	124		
Cristal Fijo lado de 120	96	111	246	189	159	174	113	128	167	151
Cristal Fijo lado de 130	100	115	256	197	168	183	117	132	171	154
Cristal Fijo lado de 140	109	124	267	206	178	193	121	136	174	157
Cristal Fijo lado de 150	113	128	278	214	188	203	125	140	177	160
Cristal Fijo lado de 160	113	143	289	223	196	211	128	143	180	163
Cristal Fijo lado de 170	113	151	300	232	206	221	133	148	183	166
Cristal Fijo lado de 180	119	158	310	241					186	169
Cristal Fijo lado de 190	129	173								
Cristal fijo lado de 200	140	188								
Corredera lado de 70	64	79	215	156	106	121	76	91		100
Corredera lado de 75	64	79	215	156			78	94		110
Corredera lado de 80	71	86	220	169	114	129	82	97		120
Corredera lado de 90	75	90	226	178	124	139	88	103		130
Corredera lado de 100	84	99	232	191	134	149	93	108		140
Corredera lado de 110	90	104	237	199	143	158	99	114		
Corredera lado de 120	96	111	243	210	151	166	106	121	177	157
Corredera lado de 130	100	115	253	218	160	175	112	127	181	160
Corredera lado de 140	109	124	264	227	168	183	117	132	184	163
Corredera lado de 150	110	128	274	236	177	192	123	138	187	166
Corredera lado de 160	110	131	286	245	186	201	129	144	190	169
Corredera lado de 170	110	133	297	253	197	212	136	151	193	172
Corredera lado de 180	110	133	307	262					196	175
Corredera Lado de 190	110	133								
Corredera lado de 200	110	133								
Cristal lateral fijo 70	170	195	217	204	186	201	186	201	159	161
Cristal lateral fijo 75	175	200	229	217	190	205	190	205	163	168
Cristal lateral fijo 80	180	205	239	229	196	211	196	211	181	175
Cristal lateral fijo 90	190	215	250	241	207	222	207	222	189	189

RECAMBIOS PANELES DE BAÑERA	Puntos
Bisagra Glass (1 uni)	42
Brazo soporte bañera Open	38
Cristal fijo Open bañera	70
Puerta Open bañera	103
Bisagra Open	17

REC. SCREEN CR	Puntos
Goma vertical	8
Goma inferior	6
Perfil a pared	16
Perfil corner	40
Bisagra sup/inf moving	17
Pinza brazos	8

BRAZOS SUJECIÓN	Puntos
Vetrum brazo lateral	52
Vetrum brazo frontal	76
Open	32
Glass	32
Vitro brazo frontal	42
Vitro brazo lateral	66
Vitro brazo vértice	32
Kenna brazo frontal	42
Kenna brazo lateral	66

SERÁ NECESARIO INDICAR MODELO Y REFERENCIA DE LA MAMPARA  
PARA CURSAR PEDIDO DE CUALQUIER REPUESTO

## DESPIECE PUNTOS/REFERENCIA SERIES FUTURA/BASIC/VITRO

	TRANSPARENTE		FROST PLUS	
	Ref.	Puntos	Ref.	Puntos
Cristales Fijo + Puerta lado de 65-70	5018	116	6018	137
Cristales Fijo + Puerta lado de 70-75	5029	121	6029	143
Cristales Fijo + Puerta lado de 75-80	5019	126	6019	147
Cristales Fijo + Puerta lado de 80-85	5030	132	6030	153
Cristales Fijo + Puerta lado de 85-90	5020	137	6020	158
Cristales Fijo + Puerta lado de 90-95	5031	140	6031	163
Cristales Fijo + Puerta lado de 95-100	5021	142	6021	169
Cristales Fijo + Puerta lado de 115-120	5022	163	6022	200
Cristales Fijo + Puerta frontal de 95-100	5001	145	6001	172
Cristales Fijo + Puerta frontal de 100-105	5002	152	6002	179
Cristales Fijo + Puerta frontal de 105-110	5003	158	6003	185
Cristales Fijo + Puerta frontal de 110-115	5004	163	6004	192
Cristales Fijo + Puerta frontal de 115-120	5005	167	6005	199
Cristales Fijo + Puerta frontal de 120-125	5006	174	6006	206
Cristales Fijo + Puerta frontal de 125-130	5007	179	6007	213
Cristales Fijo + Puerta frontal de 130-135	5008	183	6008	218
Cristales Fijo + Puerta frontal de 135-140	5009	189	6009	225
Cristales Fijo + Puerta frontal de 140-145	5010	194	6010	232
Cristales Fijo + Puerta frontal de 145-150	5011	199	6011	239
Cristales Fijo + Puerta frontal de 150-155	5012	206	6012	246
Cristales Fijo + Puerta frontal de 155-160	5013	211	6013	253
Cristales Fijo + Puerta frontal de 160-165	5014	215	6014	257
Cristales Fijo + Puerta frontal de 165-170	5015L	217	6015L	276
Cristales Fijo + Puerta frontal de 170-175	5016L	223	6016L	284
Cristales Fijo + Puerta frontal de 175-180	5017L	229	6017L	291
Cristales Fijo + Puerta frontal de 180-190	5023L	239	6023L	306
Cristales Fijo + Puerta frontal de 190-200	5024L	250	6024L	321
Lateral fijo de 70	5025	183	6025	205
Lateral fijo de 75	5057	187	6057	215
Lateral fijo de 80	5026	194	6026	222
Lateral fijo de 90	5027	206	6027	234

## PERFILERÍA + ACCESORIOS

	BASIC		VITRO		FUTURA		BASIC TITANIO		BASIC NEGRA	BASIC BLANCA	Puntos
	Ref.	Puntos	Ref.	Puntos	Ref.	Puntos	Ref.	Puntos	Ref.	Ref.	
Kit angular vértice 120x90	5423	245	5523	383	5323	475	5563	285	5490	5580	265
Kit angular vértice 140x100	5424	255	5524	393			5564	295	5491	5581	275
Kit frontal hasta 140	5434	176	5534	257	5334	300	5560	216	5493	5583	196
Kit frontal hasta 180	5438	184	5538	267	5338	310	5561	224	5494	5584	204
Kit frontal hasta 200	5446	201					5562	241	5495	5585	221
Kit spazio hasta 172	5451	237	5552	397	5351	430	5565	277	5496	5586	257
Kit spazio hasta 210	5454	241	5554	407	5354	440	5566	281	5497	5587	261
Kit lateral fijo	5444	25	5544	75	5346	80	5567	105	5492	5588	85

# Modelos de vinilos poliméricos

PLAZO DE ENTREGA  
1 SEMANA

TRAZOS



FROST PLUS



FROST



DESERT



METEOR



BAMBÚ



## Impresión digital sobre vinilo

PLAZO DE ENTREGA  
20 DÍAS LABORABLES

### PERSONALICE SU MAMPARA

Gracias a las posibilidades que ofrecen las innovadoras técnicas de impresión digital, podemos dar personalidad a nuestras mamparas. Con este tipo de impresión, se puede dar al cristal una imagen única mediante la incorporación de fotografías, dibujos, logos, símbolos y mucho más. Además, nuestro sistema de impresión digital incorpora una lámina para la protección y conservación de la imagen del vinilo.

Si la imagen es una fotografía de cámara de fotos, se requiere una calidad mínima de 5Mpx y formato JPG.

Si se crea la imagen o es un archivo de imagen, se requiere una resolución mínima de 300dpi, formato JPG/EPS/PDF, color CMYK y un tamaño mayor del 70% del tamaño final de impresión (1Mpx/m2). También valen archivos vectoriales.



FRONTALES  
220 puntos

ANGULARES  
280 puntos





## Plantilla cristales decorados vinilos

- A trazos  E desert   
 B frost plus  F meteor   
 C frost  G bambú

Cliente
Modelo mampara
Descripción
Referencia

Formato

F: FIJO

P: PUERTA

FRONTAL

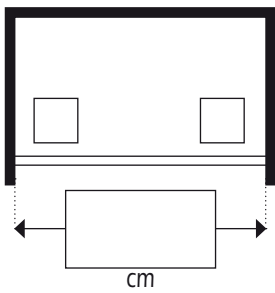

APERTURA VERTICE IZO

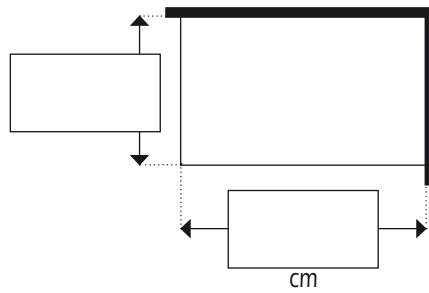

APERTURA VERTICE DER

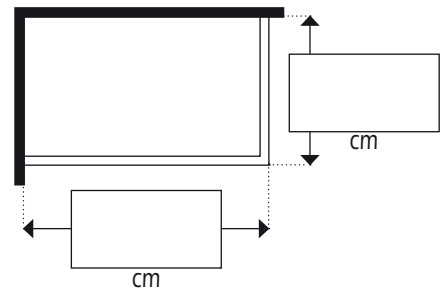

FRONTAL con LATERAL FIJO

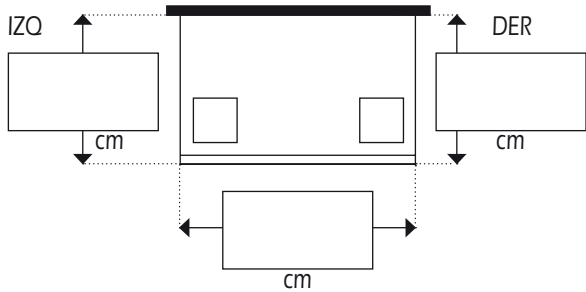

SEMICIRCULAR

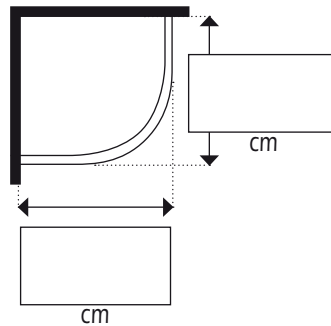

EJEMPLO FRONTAL

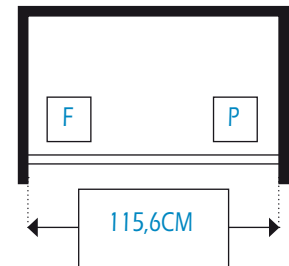

Altura decorado (max. 118cm)

		ref.	puntos
MONTAJE EN GME FROST / FROST PLUS ÁCIDO	FRONTALES	OFROST1	80
	ANGULARES	OFROST2	100
MONTAJE EN GME RESTO VINILOS	FRONTALES	0021	140
	ANGULARES	0020	200
MONTAJE EN GME IMPRESIÓN DIGITAL VINILOS	FRONTALES	0019	220
	ANGULARES	0018	280
SOLO VINILO, MONTAJE A CARGO DEL CLIENTE	FRONTALES	0023	60
	ANGULARES	0022	80



## GME PRESENTA SU COLECCIÓN DE PLATOS DE DUCHA :

Side / Hidden / Ardesia / Style Plus / Resitec:

Cuatro modelos de platos extraplano fabricados en resina con una nueva fórmula de carga mineral y gel coat sanitario de última generación que nos permite producir un plato con una reducción de peso considerable y una mayor resistencia a la torsión, manteniendo todas las ventajas de los platos en resina. Estos modelos se fabrican con **textura pizarra** y tienen un certificado antideslizamiento **clase 3**, así como una capa de Gel Coat de alta resistencia que evita posibles rayados y la aparición de organismos como hongos o moho.



## CERTIFICADOS

Preocupados por la calidad que ofrecemos a nuestros clientes, GME DIVISIÓN BAÑOS SL dispone de certificados que garantizan la calidad de todos sus productos, los cuales cumplen con todas las normativas europeas.

Al mismo tiempo GME DIVISIÓN BAÑOS SL está asociado a AIDIMME (Instituto tecnológico), en la cual se realizan inspecciones y ensayos de laboratorio para garantizar la calidad y buen funcionamiento de los productos que les ofrecemos.

# Ardesia Plus

Carga mineral última generación, textura pizarra  
Gel Coat Sanitario ISO NPG



Color carta RAL  
**+80 puntos**  
\*Plazo de entrega 25 días

A	D	B	C
70	35	Hasta 100 cm	30 cm
75	37,5	101-120 cm	35 cm
80	40	121-150 cm	40 cm
90	45	151-170 cm	45 cm
100	50	171-200 cm	50 cm
		201-220 cm	centro

80x80 / 90x90 / 100x100 tienen  
desagüe en el centro

## Técnico

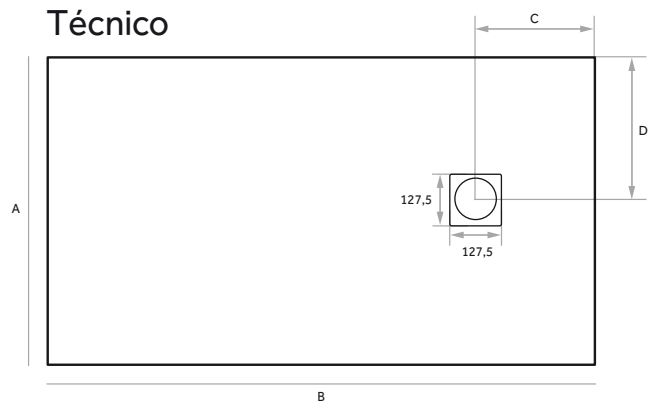



	BLANCO	GRAFITO	BEIGE	GRIS	Puntos
90x70	3886	3887	3888	3889	219
100x70	3900	3918	3936	3954	238
110x70	3901	3919	3937	3955	260
120x70	3902	3920	3938	3956	271
130x70	3903	3921	3939	3957	299
140x70	3904	3922	3940	3958	306
150x70	3905	3923	3941	3959	324
160x70	3906	3924	3942	3960	347
170x70	3907	3925	3943	3961	382
180x70	3908	3926	3944	3962	389
190x70	3972	3974	3976	3978	398
200x70	3973	3975	3977	3979	411
90x75	7500	7512	7524	7536	226
100x75	7501	7513	7525	7537	244
110x75	7502	7514	7526	7538	265
120x75	7503	7515	7527	7539	275
130x75	7504	7516	7528	7540	307
140x75	7505	7517	7529	7541	311
150x75	7506	7518	7530	7542	328
160x75	7507	7519	7531	7543	352
170x75	7508	7520	7532	7544	389
180x75	7509	7521	7533	7545	394
190x75	7510	7522	7534	7546	404
200x75	7511	7523	7535	7547	415
80x80	3830	3832	3834	3836	213
100x80	3909	3927	3945	3963	249
110x80	3910	3928	3946	3964	271
120x80	3911	3929	3947	3965	281
130x80	3912	3930	3948	3966	310
140x80	3913	3931	3949	3967	316
150x80	3914	3932	3950	3968	335
160x80	3915	3933	3951	3969	357
170x80	3916	3934	3952	3970	393
180x80	3917	3935	3953	3971	399
190x80	3980	3982	3984	3986	408
200x80	3981	3983	3985	3987	421

	BLANCO	GRAFITO	BEIGE	GRIS	Puntos
90x90	3831	3833	3835	3837	270
120x90	3840	3849	3858	3867	309
130x90	3841	3850	3859	3868	368
140x90	3842	3851	3860	3869	389
150x90	3843	3852	3861	3870	410
160x90	3844	3853	3862	3871	431
170x90	3845	3854	3863	3872	452
180x90	3846	3855	3864	3873	473
190x90	3847	3856	3865	3874	478
200x90	3848	3857	3866	3875	488
100x100	3700	3712	3724	3736	310
110x100	3701	3713	3725	3737	347
120x100	3702	3714	3726	3738	373
130x100	3703	3715	3727	3739	389
140x100	3704	3716	3728	3740	404
150x100	3705	3717	3729	3741	420
160x100	3706	3718	3730	3742	452
170x100	3707	3719	3731	3743	473
180x100	3708	3720	3732	3744	499
190x100	3709	3721	3733	3745	536
200x100	3710	3722	3734	3746	546
220x100	3711	3723	3735	3747	641

### ARDESIA XXL

	Ref.	Puntos
Largo hasta 160 Ancho 120 cm	3990	599
Largo hasta 220 Ancho 70 a 90 cm	3998	680
Largo hasta 220 Ancho 120 cm	3991	896

Plazo de entrega medio 15 días  
Desagüe central en XXL con ancho de 100 a 120 cm o largo de 200 a 220 cm.

### Suplementos opcionales



VÁLVULA VIEGA  
ref. 0366  
+35 puntos



REJILLA COLOR  
ref. 0382  
+10 puntos



REJILLA RESINA  
ref. 0378  
+20 puntos

## PLATOS A MEDIDA Y CORTE

(necesario plano técnico)

- Cortes con acabado Gel Coat ref. 7777 / 25 puntos

\*Plazo de entrega 7 días

- Cortes sin acabado Gel Coat ref. 8888 / gratuito

\*Plazo de entrega 5 días

\*Esta opción solo cuando el corte va oculto en la pared



# Ardesia Plus Semicircular

Carga mineral última generación, textura pizarra  
Gel Coat Sanitario ISO NPG



Cualquier otro color de la carta RAL +80 puntos  
Se sirve con rejilla inox

**Plazo medio de entrega 25 días**

(No se aceptarán anulaciones una vez cursado el pedido)

A	B	C	R	Kg
800	800	320	550	18
900	900	370	550	19

Técnico

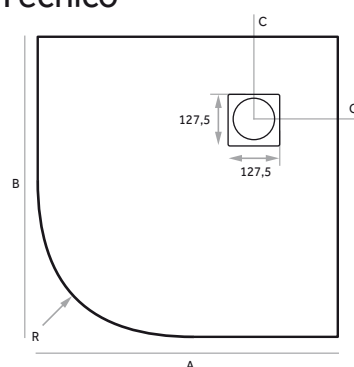



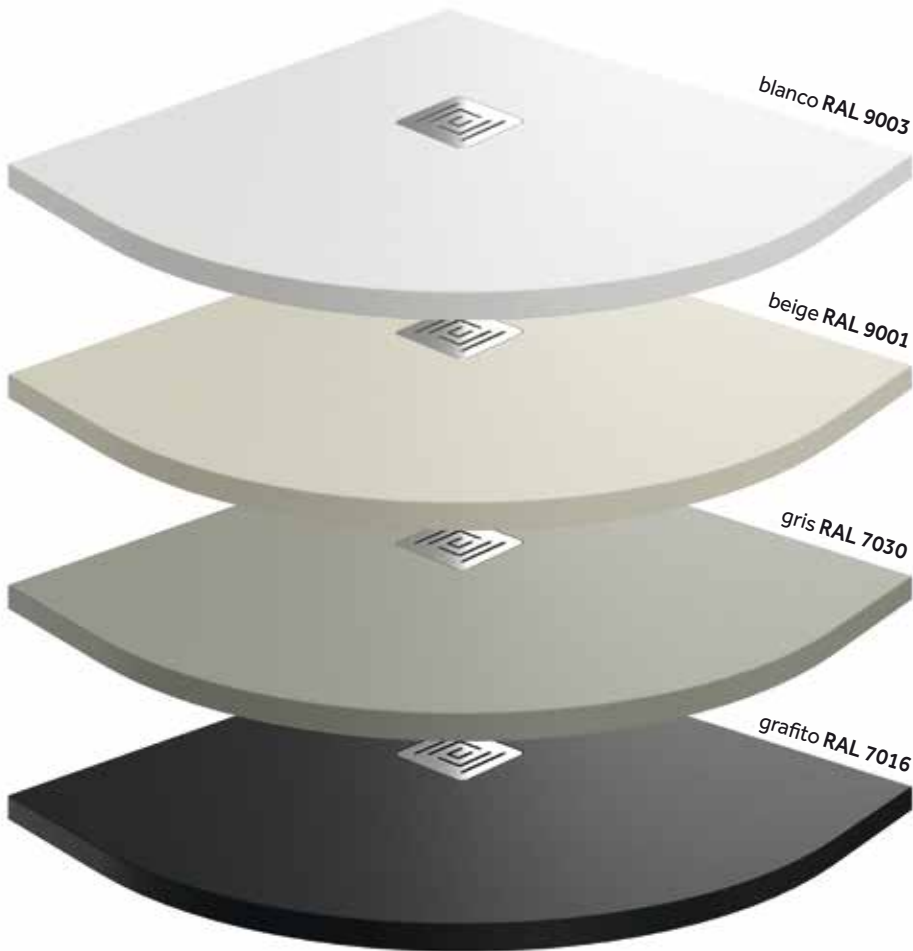

### SEMICIRCULAR RADIO STANDARD R 55

	BLANCO	GRAFITO	BEIGE	GRIS	Puntos
80x80	3820	3822	3824	3826	229
90x90	3821	3823	3825	3827	276



REJILLA RESINA  
ref. 0378  
+20 puntos



REJILLA COLOR  
ref. 0382  
+10 puntos

## PLATOS A MEDIDA Y CORTE

(necesario plano técnico)

Platos a medida tarifados según medida inmediata superior  
ej. 175x76 P.V.P. = 180X80 + corte 7777/8888

- Cortes con acabado Gel Coat ref. 7777 / 25 puntos

\*Plazo de entrega 7 días

- Cortes sin acabado Gel Coat ref. 8888 / **gratuito**

\*Plazo de entrega 5 días

\*Esta opción solo cuando el corte va oculto en la pared



# Style Plus

Carga mineral última generación, textura pizarra  
Gel Coat Sanitario ISO NPG

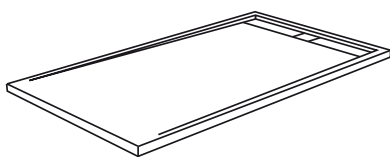

Distancia a válvula

ancho 70/80 cm      12 cm

ancho 90 cm      14 cm



Cualquier otro color de la carta RAL +80 puntos

Se sirve con rejilla inox

**Plazo medio de entrega 25 días**

(No se aceptarán anulaciones una vez cursado el pedido)



	BLANCO	GRAFITO	BEIGE	GRIS	puntos
90x70	4886	4887	4888	4889	321
100x70	4900	4918	4936	4954	332
110x70	4901	4919	4937	4955	342
120x70	4902	4920	4938	4956	353
130x70	4903	4921	4939	4957	363
140x70	4904	4922	4940	4958	374
150x70	4905	4923	4941	4959	384
160x70	4906	4924	4942	4960	395
170x70	4907	4925	4943	4961	405
180x70	4908	4926	4944	4962	416
190x70	4972	4974	4976	4978	437
200x70	4973	4975	4977	4979	447
<hr/>					
100x80	4909	4927	4945	4963	342
110x80	4910	4928	4946	4964	353
120x80	4911	4929	4947	4965	363
130x80	4912	4930	4948	4966	374
140x80	4913	4931	4949	4967	384
150x80	4914	4932	4950	4968	395
160x80	4915	4933	4951	4969	405
170x80	4916	4934	4952	4970	416
180x80	4917	4935	4953	4971	426
190x80	4980	4982	4984	4986	447
200x80	4981	4983	4985	4987	458
<hr/>					
120x90	4840	4849	4858	4867	437
130x90	4841	4850	4859	4868	479
140x90	4842	4851	4860	4870	489
150x90	4843	4852	4861	4871	521
160x90	4844	4853	4862	4872	531
170x90	4845	4854	4863	4873	584
180x90	4846	4855	4864	4874	594
190x90	4847	4856	4865	4875	668
200x90	4848	4857	4866	4876	678



CERTIFICADO CLASE 3  
Máxima Calificación  
**ANTIDESLIZANTE**

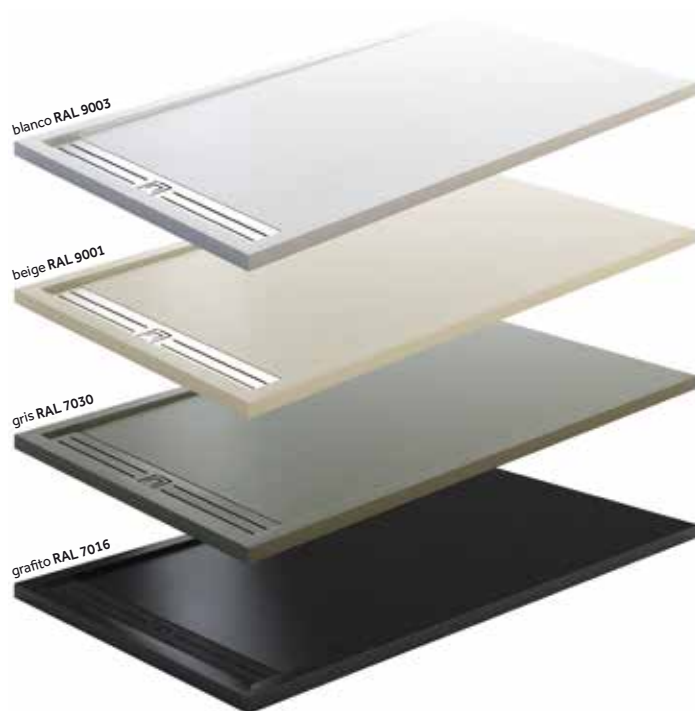

### Suplementos opcionales



VÁLVULA VIEGA  
ref. 0366  
+35 puntos



REJILLA COLOR  
ref. 0383  
+35 puntos



REJILLA RESINA  
ref. 0380  
+40 puntos

### PLATOS A MEDIDA Y CORTE

Platos a medida tarifados según medida inmediata superior  
ej. 175x76 P.V.P. = 180X80 + corte 7777/8888

#### OPCIONES CORTE

ref. 7777 / Cortes con acabado Gel Coat / 25 puntos

\*Plazo de entrega 7 días

ref. 8888 / Cortes sin acabado Gel Coat / **gratuito**

\*Plazo de entrega 5 días

\*esta opción solo cuando el corte va oculto en la pared

# Side Plus desagüe oculto

Carga mineral última generación, textura pizarra

Gel Coat Sanitario ISO NPG



## Válvula Side Plus

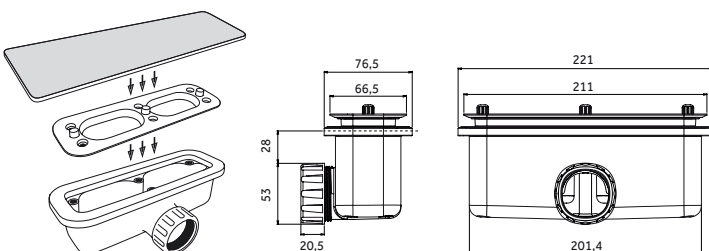

## Técnico

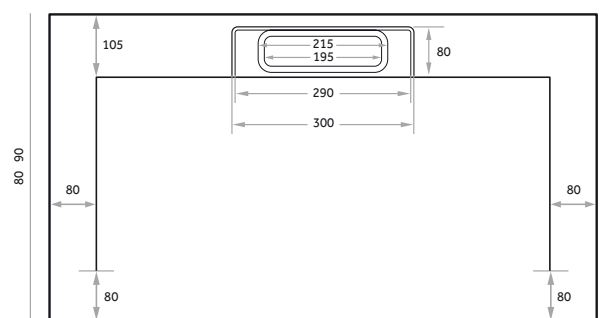

100 120 130 140 150 160 170 180 190 200



## EN STOCK

Blanco RAL 9003

ANCHO 80			ANCHO 90		
Medida	Ref.	Puntos	Medida	Ref.	Puntos
100x80	6909	336	-	-	-
110x80	6910	362	-	-	-
120x80	6911	373	120x90	6840	462
130x80	6912	383	130x90	6841	504
140x80	6913	394	140x90	6842	515
150x80	6914	425	150x90	6843	551
160x80	6915	436	160x90	6844	562
170x80	6916	457	170x90	6845	593
180x80	6917	467	180x90	6846	604
190x80	6980	488	190x90	6847	693
200x80	6981	499	200x90	6848	704



CERTIFICADO CLASE 3  
Máxima Calificación  
**ANTIDESLIZANTE**



\*Incluye válvula técnica extraplana (C con fijación tornillos + tapa oculta desagüe)

## PLATOS A MEDIDA Y CORTE

Platos a medida tarifados según medida inmediata superior  
ej. 175x76 P.V.P. = 180X80 + corte 7777/8888

### OPCIONES CORTE

ref. 7777 / Cortes con acabado Gel Coat / 25 puntos

\*Plazo de entrega 7 días

ref. 8888 / Cortes sin acabado Gel Coat / **gratuito**

\*Plazo de entrega 5 días

\*Esta opción solo cuando el corte va oculto en la pared

Colores Gris, Grafito y Beige +30 puntos  
plazo medio de entrega **15 días**

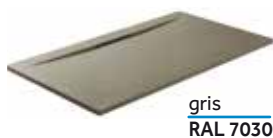

gris  
RAL 7030



grafito  
RAL 7016



beige  
RAL 9001



Cualquier otro color de la carta RAL +80 puntos  
plazo medio de entrega **25 días**

(No se aceptarán anulaciones una vez cursado el pedido)



# Hidden Plus-marco oculto

Carga mineral última generación, textura pizarra

Gel Coat Sanitario ISO NPG



## Distancia a válvula

Hasta 100 cm	30 cm
101-130 cm	35 cm
131-150 cm	40 cm
151-170 cm	45 cm
171-200 cm	50 cm

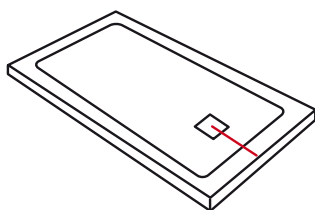

## Técnico

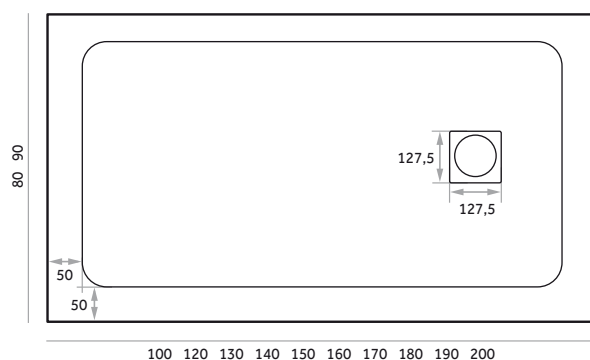





## STOCK

Blanco RAL 9003

ANCHO 80			ANCHO 90		
Medida	Ref.	Puntos	Medida	Ref.	Puntos
100x80	5909	294	-	-	-
110x80	5910	320	-	-	-
120x80	5911	331	120x90	5840	341
130x80	5912	352	130x90	5841	383
140x80	5913	362	140x90	5842	394
150x80	5914	383	150x90	5843	415
160x80	5915	394	160x90	5844	425
170x80	5916	415	170x90	5845	462
180x80	5917	425	180x90	5846	473
190x80	5980	446	190x90	5847	494
200x80	5981	457	200x90	5848	504



CERTIFICADO CLASE 3  
Máxima Calificación  
**ANTIDESLIZANTE**



\*Incluye válvula standard extraplana Cc con fijación tornillos + Rejilla Inox 316 de 2 mm

## Suplementos opcionales



VÁLVULA VIEGA  
ref. 0366  
+35 puntos

## PLATOS A MEDIDA Y CORTE

(necesario plano técnico)

Platos a medida tarifados según medida inmediata superior  
ej. 175x76 P.V.P. = 180X80 + corte **7777/8888**

- Cortes con acabado Gel Coat ref. **7777** / 25 puntos

\*Plazo de entrega 7 días

- Cortes sin acabado Gel Coat ref. **8888** / **gratuito**

\*Plazo de entrega 5 días

\*Esta opción solo cuando el corte va oculto en la pared



REJILLA COLOR  
ref. 0382  
+10 puntos



REJILLA RESINA  
ref. 0378  
+20 puntos

Colores Gris, Grafito y Beige +30 puntos  
plazo medio de entrega **15 días**



gris  
RAL 7030



grafito  
RAL 7016



beige  
RAL 9001



Cualquier otro color de la carta RAL +80 puntos

plazo medio de entrega **25 días**

(No se aceptarán anulaciones una vez cursado el pedido, se sirve con rejilla inox)

# Resitec Rock

Resina técnica sin carga mineral, acabado piedra  
Gel Coat Sanitario ISO NPG

+ Ligero  
+Cálido al tacto



Las características del material aconsejan seguir los pasos de la hoja de instrucciones de instalación incluida en el producto.



Cualquier otro color de la carta RAL +80 puntos  
plazo medio de entrega **25 días**

(No se aceptarán anulaciones una vez cursado el pedido, se sirve con rejilla inox)



	BLANCO	GRAFITO	BEIGE	GRIS	puntos
80x80	1490	1492	1494	1496	251
90x90	1491	1493	1495	1497	266
100x70	1500	1516	1532	1548	251
110x70	1501	1517	1533	1549	259
120x70	1502	1518	1534	1550	266
130x70	1503	1519	1535	1551	297
140x70	1504	1520	1536	1552	303
150x70	1505	1521	1537	1553	323
160x70	1506	1522	1538	1554	338
170x70	1507	1523	1539	1555	353
<hr/>					
100x80	1508	1524	1540	1556	266
110x80	1509	1525	1541	1557	271
120x80	1510	1526	1542	1558	280
130x80	1511	1527	1543	1559	300
140x80	1512	1528	1544	1560	307
150x80	1513	1529	1545	1561	338
160x80	1514	1530	1546	1562	353
170x80	1515	1531	1547	1563	368
180x80	1567	1471	1474	1477	449
190x80	1568	1472	1475	1478	461
200x80	1569	1473	1476	1479	469
<hr/>					
100x90	1480	1481	1482	1483	353
110x90	1484	1485	1486	1487	361
120x90	1571	1580	1589	1598	368
130x90	1572	1581	1590	1599	372
140x90	1573	1582	1591	1600	378
150x90	1574	1583	1592	1601	440
160x90	1575	1584	1593	1602	455
170x90	1576	1585	1594	1603	469
180x90	1577	1586	1595	1604	484
190x90	1578	1587	1596	1605	499
200x90	1579	1588	1597	1606	513



CERTIFICADO CLASE 3  
Máxima Calificación  
**ANTIDESLIZANTE**

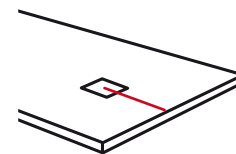
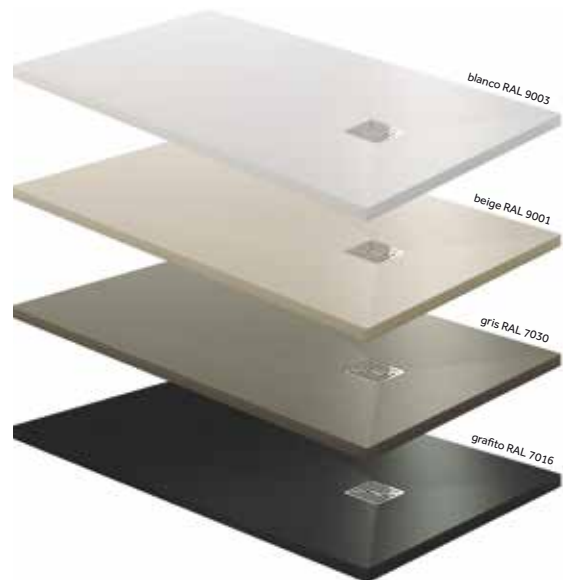

Distancia a válvula

Hasta 170 cm	38 cm
171 - 200 cm	40 cm

\*Incluye Válvula standard Extraplana C (con fijación tornillos + Rejilla Inox 316 de 2mm



Válvula Standard

## PLATOS A MEDIDA Y CORTE

(necesario plano técnico)

Platos a medida tarifados según medida inmediata superior  
ej. 175x76 P.V.P. = 180X80 + corte 7777

- Cortes con acabado Gel Coat ref. 7777 / 25 puntos

\*Plazo de entrega medio 7 días

### Suplemento



ref. 0366  
+30 puntos

# PANELES DE BAÑERA



## NUEVOS PANELES ARDESIA PLUS +RIGIDO +RESISTENTE

Paneles con fibra de vidrio y Gel Coat de 0,6 cm de grosor

Acabado [STYLE/ARDESIA/SIDE/HIDDEN](#)

**NOVEDAD**

Largo	Altura hasta 55		Altura 55 a 110	
	Referencia	Puntos	Referencia	Puntos
Hasta 70 cm	1411	71	1415	144
De 71 cm a 100 cm	1412	102	1416	205
De 101 cm a 140 cm	1413	144	1417	288
De 141 cm a 208 cm	1414	225	1418	399

Plazo entrega aprox. 15 días

## PANELES DE BAÑERA RESITEC

Paneles de 1 cm de grosor

[RESITEC ROCK](#) (Piedra)

Largo	Altura hasta 70		Altura 71 a 110	
	Referencia	Puntos	Referencia	Puntos
Hasta 70 cm	1400	78	1404	153
De 71 cm a 100 cm	1401	115	1405	217
De 101 cm a 140 cm	1402	153	1406	296
De 141 cm a 208 cm	1403	214	1407	418

Plazo entrega aprox. 15 días ROCK

## ZÓCALOS RESITEC / PLUS

Zócalos de hasta 9 cm de altura, 23 puntos el metro lineal

Zócalos de hasta 9 cm a 15 cm de altura, 44 puntos el metro lineal

\*Indicar Modelo / Medidas / Color

Plazo entrega aprox. 15 días

# NUEVOS PLATOS ENMARCADOS ARDESIA PLUS

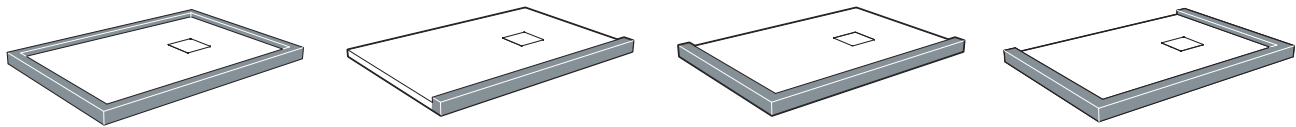

## NOVEDAD

Descripción	Referencia	Puntos
Metro lineal enmarcado 4x4 cm std	0970	50m/l

Necesario plano técnico.

Para calcular los puntos de un plato con marco, sumar al punto del plato, los puntos de los metros lineales de enmarcado. El marco tendrá unas medidas de 4x4 si no se especifica.

Plazo de entrega aproximado 15 días.

## RECAMBIOS PLATOS DE DUCHA

### REJILLAS



Rejila Inox Ardesia/Hidden  
9 Puntos



Rejila Inox Style 70  
24 Puntos  
Rejila Inox Style 80  
26 Puntos  
Rejila Inox Style 90  
28 Puntos



Tapa Side  
30 Puntos

### RESPUESTOS VÁLVULA



Válvula side ref. 0358  
20 Puntos



Válvula standard ref. 0372  
15 Puntos



Sifón  
5 Puntos



Cestillo  
5 Puntos



Tapón sifón  
3 Puntos



Conjunto gomas  
3 Puntos

### KITS REPARACIÓN



Kit pintura  
20 Puntos  
Kit pintura + masilla  
24 Puntos  
Kit pintura plato completo  
50 Puntos

# IO<sup>®</sup> by GME

IO<sup>®</sup> es la marca registrada a nivel europeo de las griferías diseñadas y producidas por GME División Baños S.L. Con más de 30 años de experiencia en la comercialización y distribución de productos orientados al acondicionamiento integral del baño.

El grupo desarrolla dos líneas generales de negocio, una de ellas actúa como delegación de fabricantes de primer nivel, la otra, fabrica y comercializa productos bajo la marca GME.

Griferías IO by GME cuenta con todas las líneas de grifería necesarias para el acondicionamiento del baño y la cocina, con una gran variedad de formatos y colores siguiendo las últimas tendencias del mercado.



CONSULTA CATÁLOGO  
GRIFERÍA IO











RHIO  
Ref. 3165  
44 puntos



MARRIOT  
Ref. 3150  
55 puntos



MARRIOT BLANCO  
Ref. 3150BL  
70 puntos



CASSIO NEGRO  
Ref. 3070  
77 puntos



CASSIO TITANIO  
Ref. 3105  
88 puntos



SIRIO CROMO  
Ref. 3170  
55 puntos



SIRIO ORO  
Ref. 3172OR  
125 puntos



ATRIO  
Ref. 3076  
132 puntos



SIRIO NIQUEL  
Ref. 3170NK  
70 puntos



SIRIO BLANCO  
Ref. 3170BL  
65 puntos



DIOR CROMO  
Ref. 3120  
77 puntos



DIOR NEGRO  
Ref. 3125  
88 puntos





**INVERTER C BLANCA**  
Ref. 3081BL  
246 puntos



**INVERTER R BLANCA**  
Ref. 3080BL  
199 puntos



**INVERTER R ORO**  
Ref. 3080OR  
248 puntos



**INVERTER R NIQUEL**  
Ref. 3080NK  
213 puntos



**INVERTER R**  
Ref. 3080  
157 puntos



**INVERTER R NEGRA**  
Ref. 3135  
195 puntos



**INVERTER C**  
Ref. 3081  
199 puntos



**INVERTER C NEGRA**  
Ref. 3136  
238 puntos



**QUADRA**  
Ref. 3013  
314 puntos



**ROUND**  
Ref. 3015  
209 puntos



**ROUND ÉLITE NEGRA**  
Ref. 3097  
363 puntos



**ROUND TITANIO**  
Ref. 3098  
435 puntos



**ROUND ÉLITE TITANIO**  
Ref. 3099  
501 puntos



**QUADRA ÉLITE NEGRA**  
Ref. 3095  
391 puntos





## GRIFERÍA EMPOTRABLE DE LAVABO



**SIRIO CROMO**

Ref. 3190  
73 puntos



**SIRIO ORO**

Ref. 3190OR  
92 puntos



**CASSIO BLANCO**

Ref. 3048BL  
198 puntos



**ORION NEGRO**

Ref. 3029  
187 puntos

## GRIFERÍA EMPOTRABLE DE DUCHA



**ROUND CROMO  
MONOMANDO**

Ref. 3086  
160 puntos



**SIRIO BLANCO  
MONOMANDO**

Ref. 3086BL+4040BL  
191 puntos



**SIRIO ORO  
MONOMANDO**

Ref. 3086OR+4040OR  
244 puntos



**ROUND NEGRO  
TERMOSTÁTICO**

Ref. 3083  
248 puntos



**ORION CROMO  
MONOMANDO**

Ref. 3088  
171 puntos



**ORION BLANCO  
MONOMANDO**

Ref. 3088BL  
214 puntos



**ORION CROMO  
TERMOSTÁTICO**

Ref. 3084  
237 puntos



**ORION NEGRO  
TERMOSTÁTICO**

Ref. 3085  
259 puntos





**EXTRAIBLE DESIGN CROMO**  
Ref. 3141  
105 puntos



**DIOR CROMO**  
Ref. 3140  
110 puntos



**NOAH ACERO**  
Ref. 3184  
60 puntos



**ROUND ACERO**  
Ref. 3138  
65 puntos



**ROUND CROMO**  
Ref. 3142  
55 puntos



**NOAH NEGRO**  
Ref. 3183  
70 puntos



**OSMOSIS ACERO**  
Ref. 3137  
115 puntos



**QUADRA CROMO**  
Ref. 3143  
72 puntos



**QUADRA ACERO**  
Ref. 3181  
80 puntos



**SILVER CROMO**  
Ref. 3145  
66 puntos



**EXTRAIBLE ROUND CROMO**  
Ref. 3144  
88 puntos



**EXTRAIBLE ROUND ACERO**  
Ref. 3180  
95 puntos

# EXPOSITORES MAMPARAS

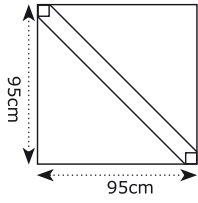

ref. GME01  
2 Mamparas de **90x90**

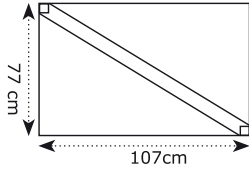

ref. GME02  
2 Mamparas de **100x70**

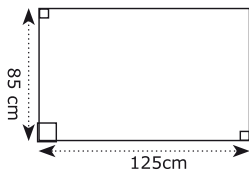

ref. GME04  
3 Mamparas  
mampara **120x80**  
open/akord **70**  
frontal **110**

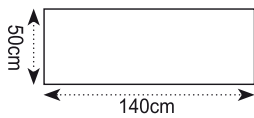

ref. GME07  
3 Mamparas  
frontal **140**



ref. GME11

Exposición con mástiles de 2 m  
en aluminio lacado blanco

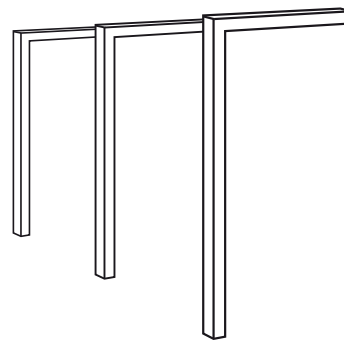

# EXPOSITOR PLATOS



ref. GME06  
2 platos 120x70  
120x80



# EXPOSITORES GRIFERÍA IO



ref. GME03  
4 columnas ó duchas vistas



ref. GME10  
6 grifos IO  
1 ducha vista

ref. GME09  
4 conjuntos grifería  
2 duchas vistas/1 ducha+empotrable



ref. GME13  
Medida 80x40 cm  
9 grifos IO



ref. GME14  
Medida 120x61 cm  
14 grifos IO



ref. GME08  
3 grifos IO



ref. GME12  
2 grifos IO



MUESTRARIO  
ACABADOS  
GRIFOS  
SIRIO

100 Puntos

**QME**



# GME

DIVISION BAÑOS



## GME DIVISIÓN BAÑOS S.L.

Polígono Ciudad de Mudeco  
C/ Pinadeta 16 - 46930  
Quart de Poblet - Valencia - España

### ATENCIÓN AL CLIENTE

Telf. +34 96 252 18 55  
Fax +34 96 252 18 56  
info@gmelorente.com  
www.gmelorente.com

### PEDIDOS

pedidos@gmelorente.com

